

Pure
BY TUNTURI®

English

12

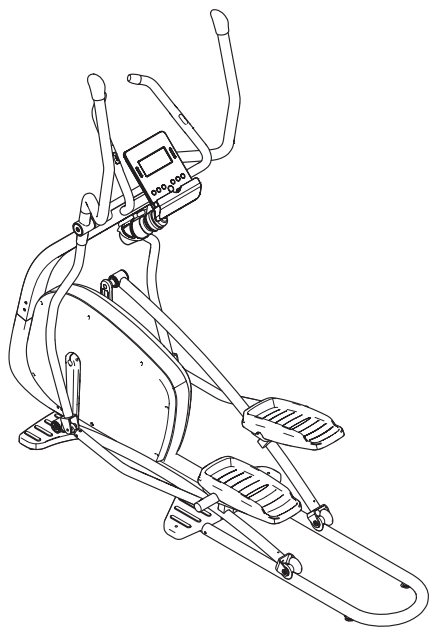





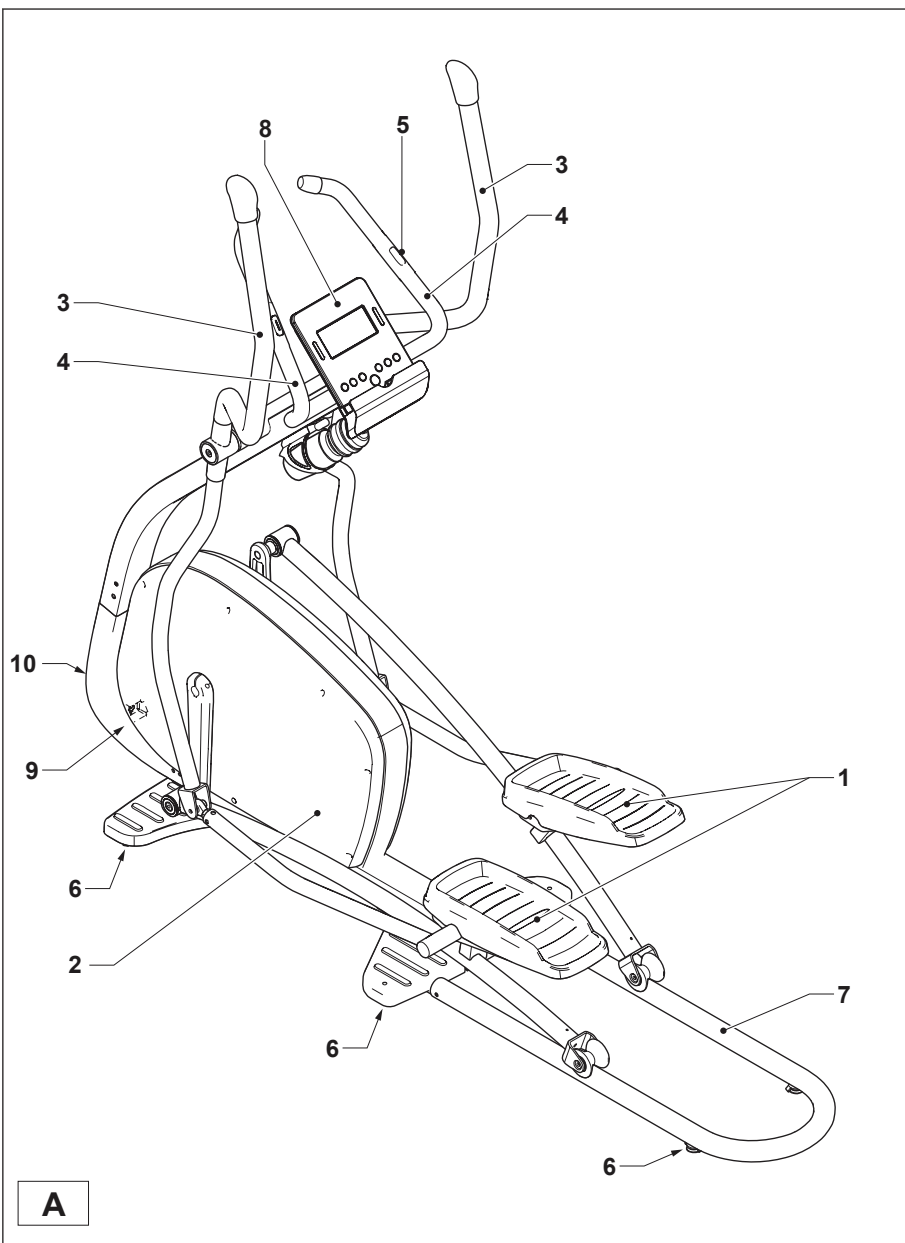



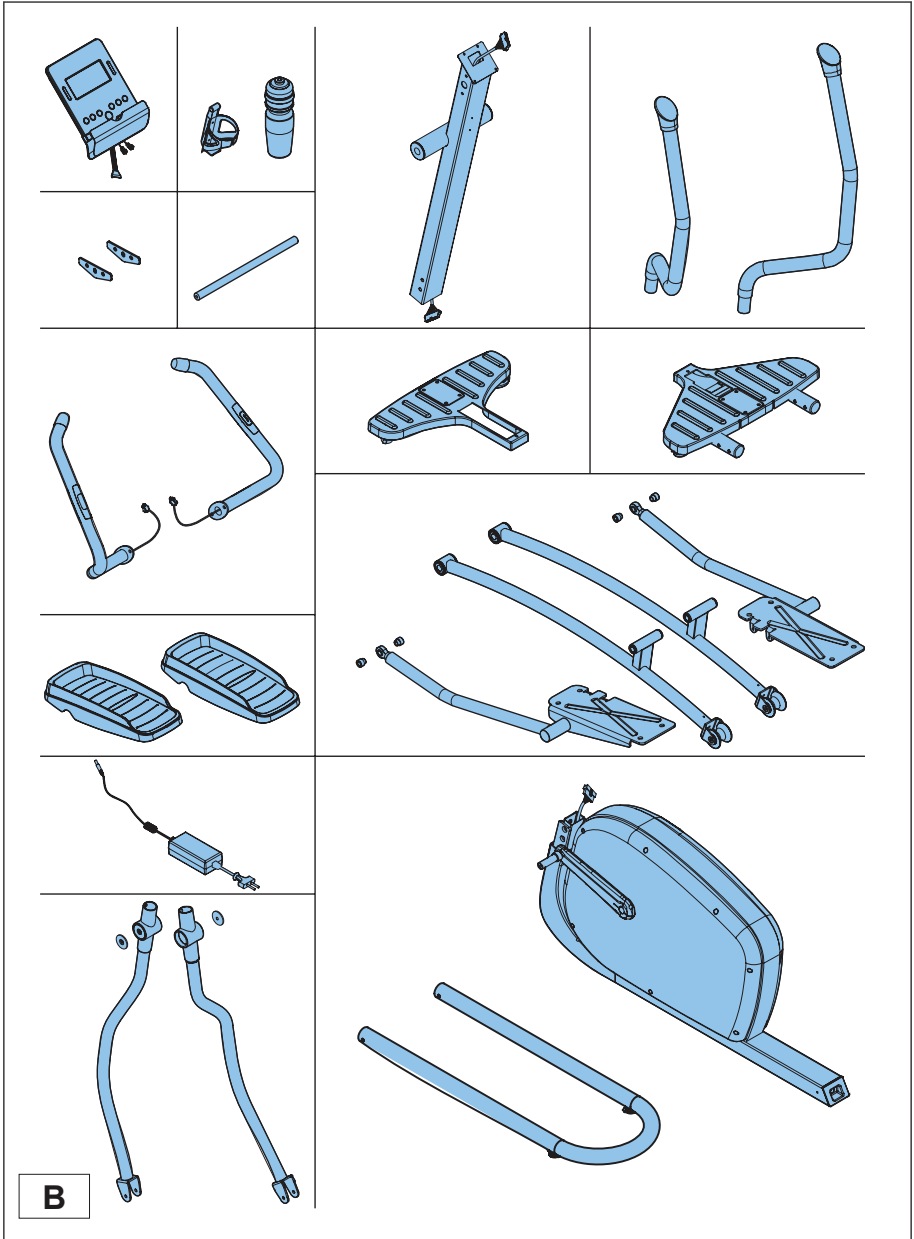









CF 4.0

From the **Heart** 



A



- | | | | | | |
|--|--|---|---|---|---|
| 11 (10x)

M5*12 | 12 (26x)

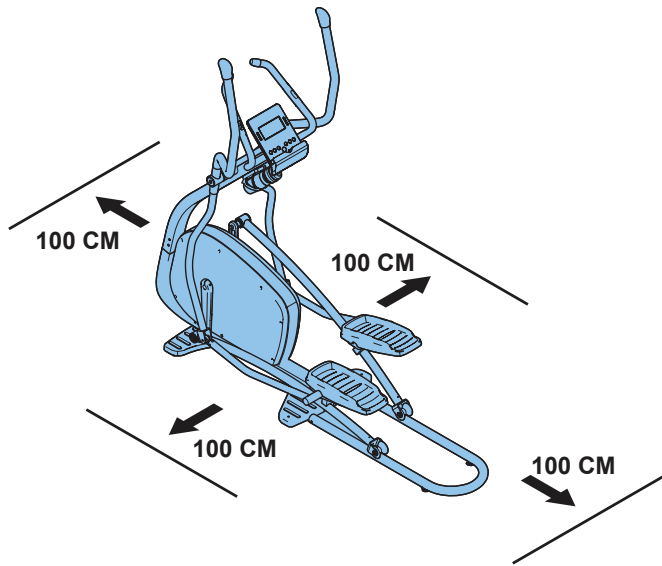
M8*16*1.2 | 13 (22x)

M8 | 14 (2x)

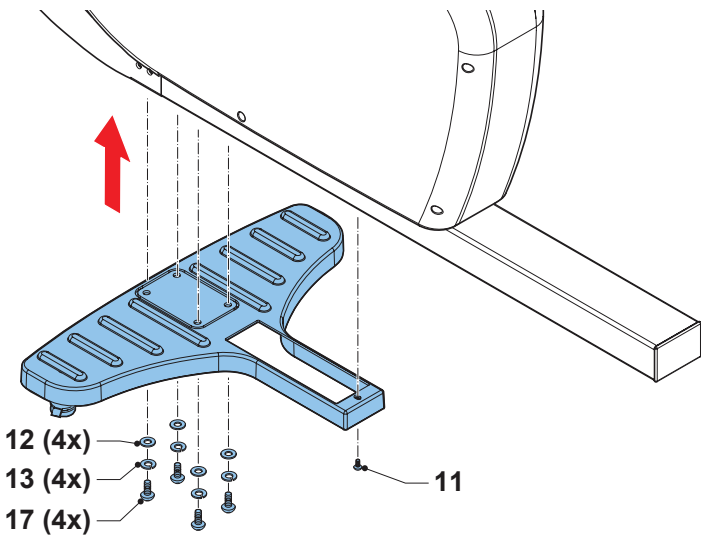
» 27*20*0.4 | 15 (6x)

M8*56 | 16 (6x)

M8 |
| 17 (12x)

M8*20 | 18 (4x)

M8*15 | 19 (2x)

M5*15 | 20 (2x)

M8*25 | 21 (4x)

M8*25 | 22 (2x)

M8*38*2.0 |
| 23 (8x)

M5*1.5 | 24 (8x)

M5 | 25 (2x)

M8*28*2.0 | 26 (2x)

M8*41.7*5 | 27 (4x)

M5*12 | |

C



D0



D1

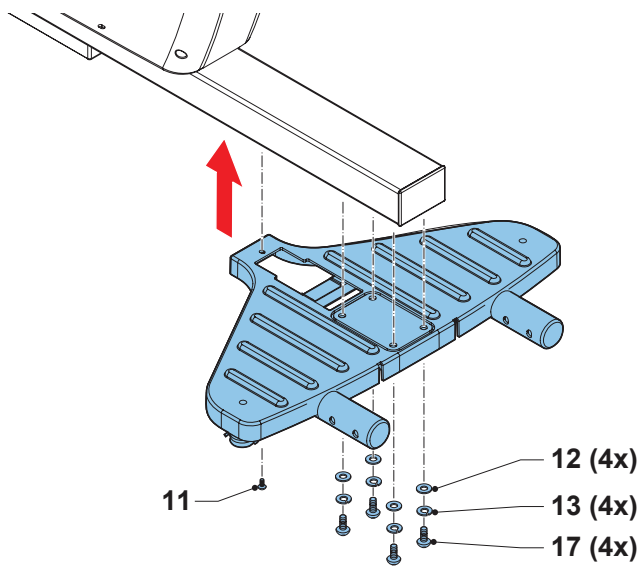

D2

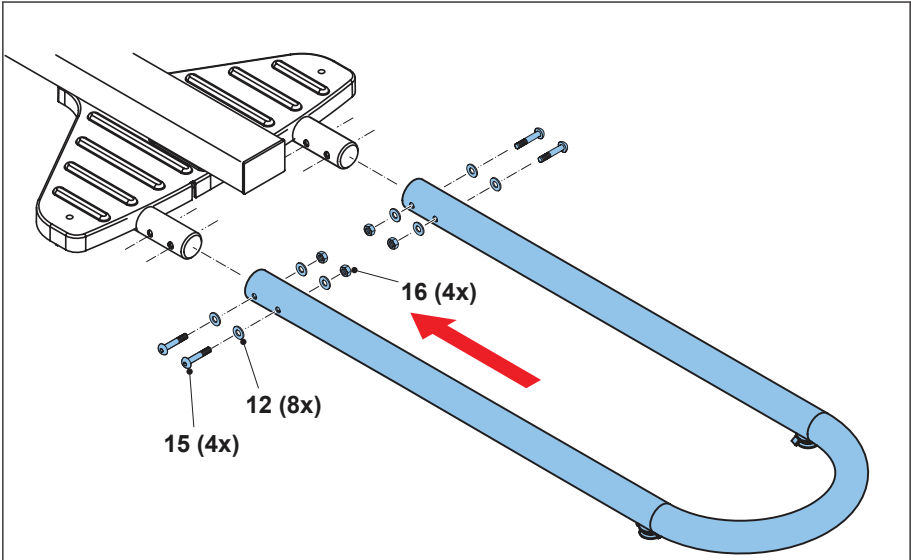

D3

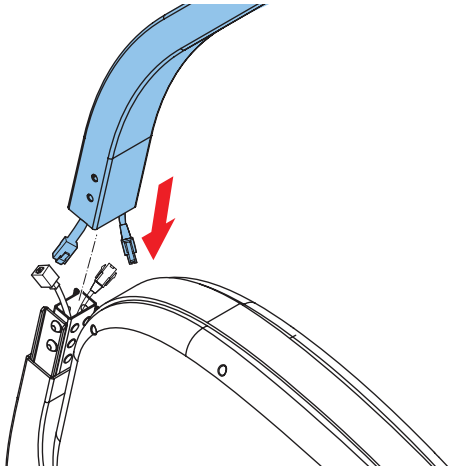
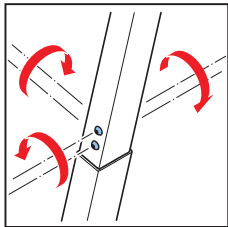
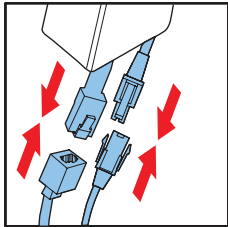

D4

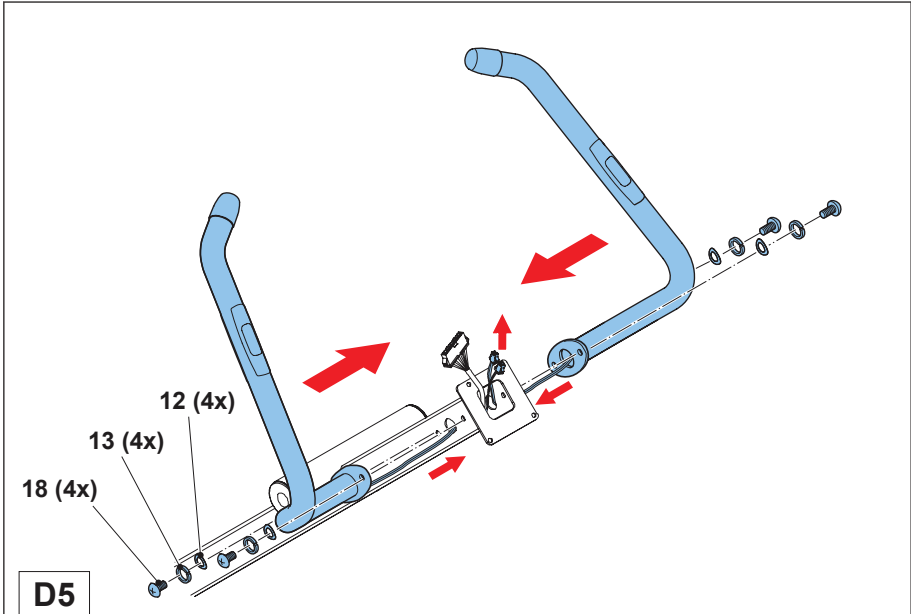

D5

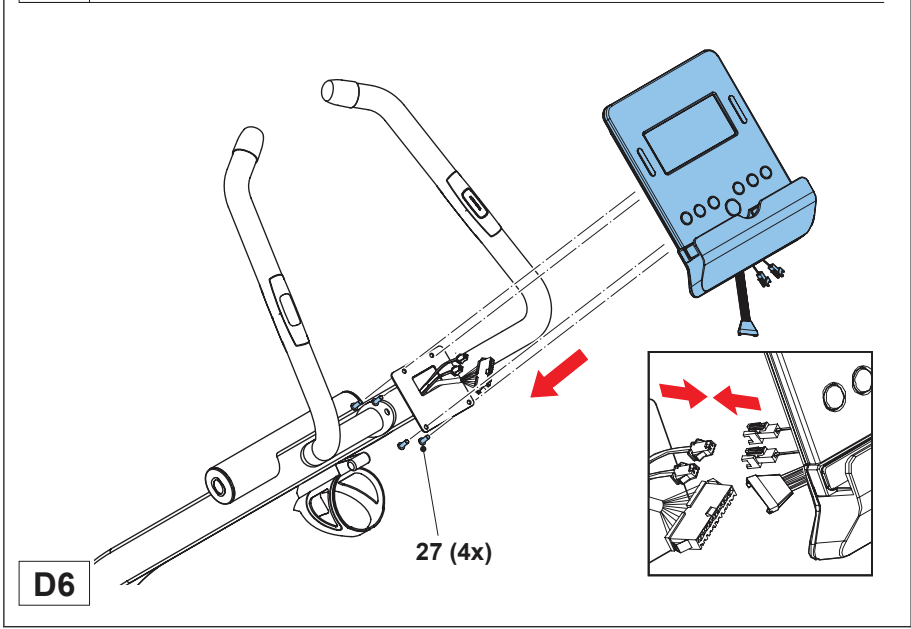

D6

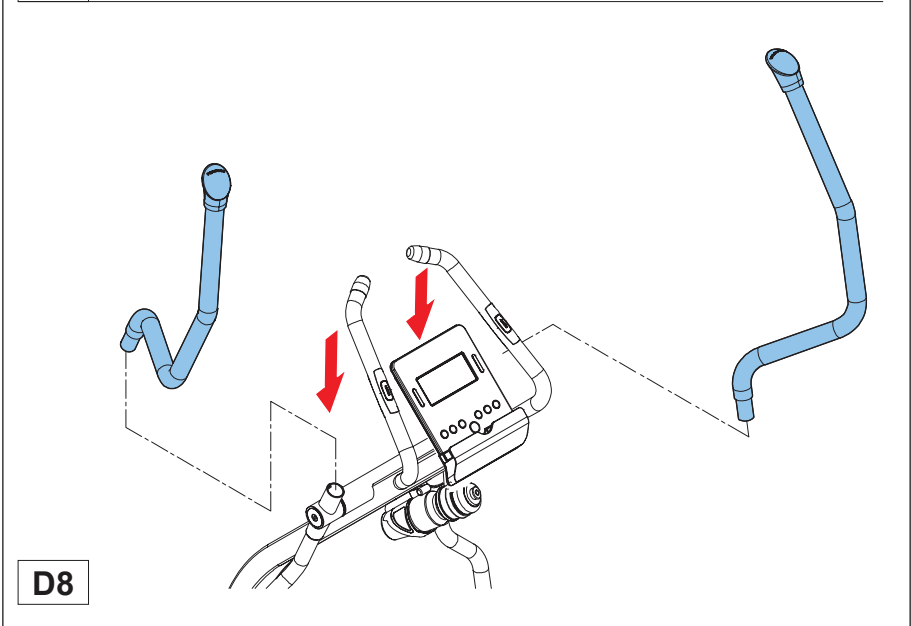
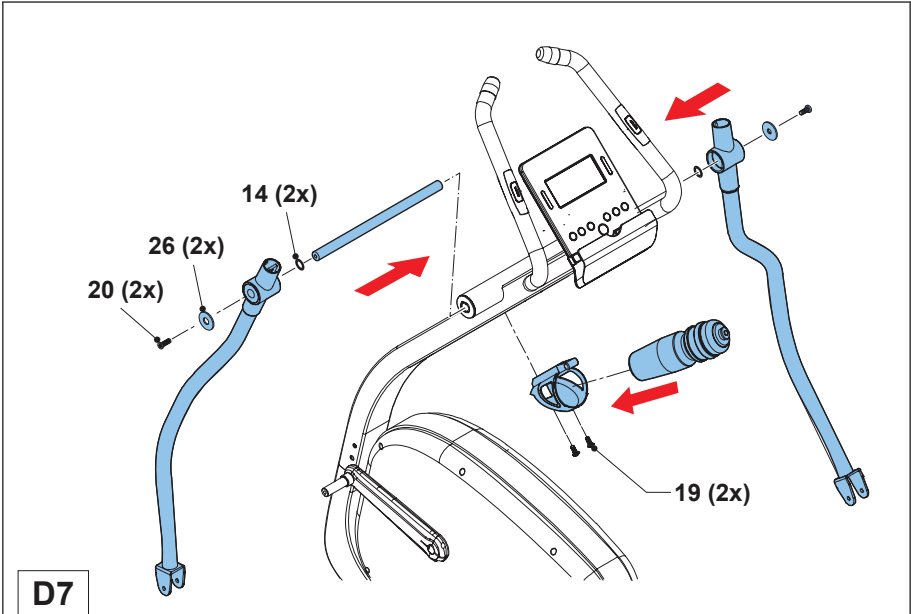

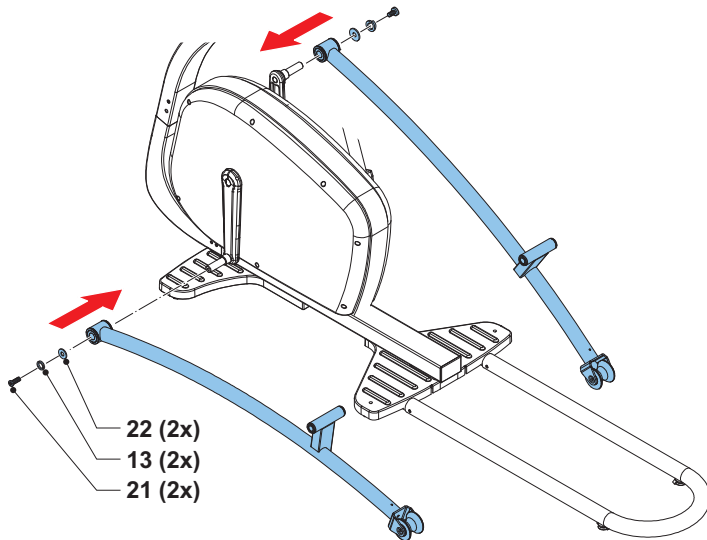

D9

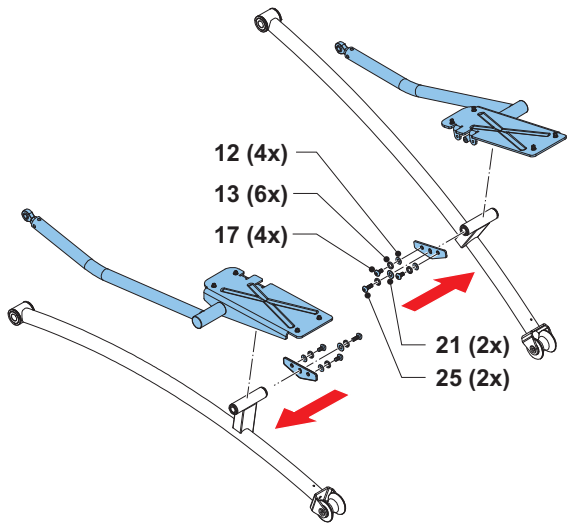

D10

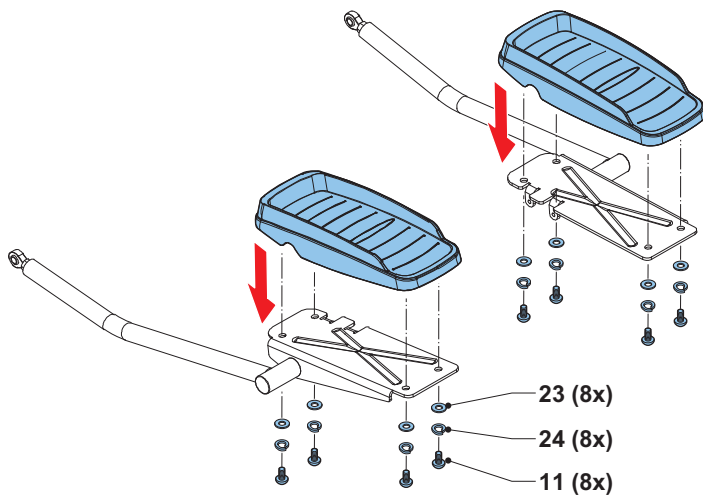

D11

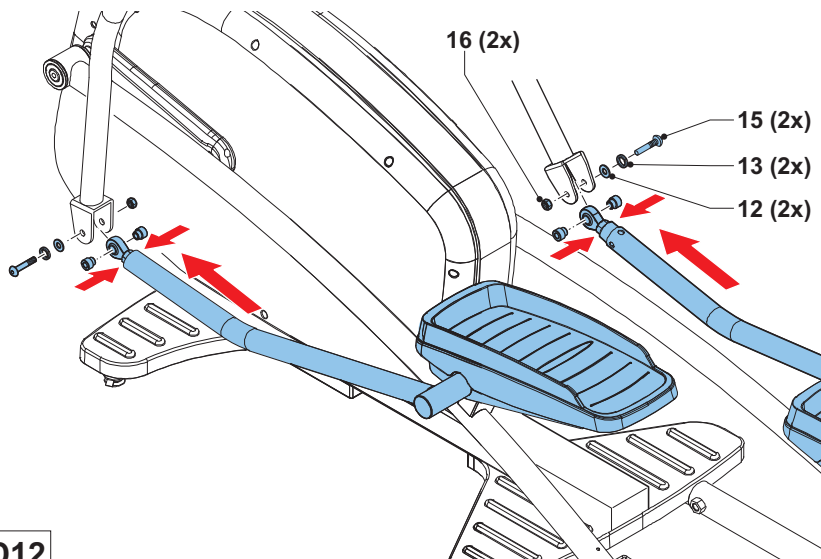

D12

CROSSTRAINER

Welcome to the world of Tunturi Fitness!

Thank you for purchasing this piece of Tunturi equipment. Tunturi offers a wide range of professional fitness equipment, including crosstrainers, treadmills, exercise bikes, rowers and vibration plates. The Tunturi equipment is suitable for the entire family, no matter what fitness level. For more information, please visit our website www.tunturi.com

Safety warnings



WARNING

- Read the safety warnings and the instructions. Failure to follow the safety warnings and the instructions can cause personal injury or damage to the equipment. Keep the safety warnings and the instructions for future reference.



WARNING

- Heart rate monitoring systems may be inaccurate. Over exercise may result in serious injury or death. If you feel faint stop exercising immediately.
- The equipment is suitable for domestic and professional use only (e.g. hospitals, fire stations, hotels, schools etc.). Max. usage is limited to 6 hrs a day. The equipment is not suitable for full commercial use (e.g. large gyms).
 - The use of this equipment by children or persons with a physical, sensory, mental or motorial disability, or lack of experience and knowledge can give cause to hazards. Persons responsible for their safety must give explicit instructions or supervise the use of the equipment.
 - Before starting your workout, consult a physician to check your health.
 - If you experience nausea, dizziness or other abnormal symptoms, immediately stop your workout and consult a physician.
 - To avoid muscular pain and strain, start each workout by warming up and finish each workout by cooling down. Remember to stretch at the end of the workout.
 - The equipment is suitable for indoor use only. The equipment is not suitable for outdoor use.

-
- Only use the equipment in environments with adequate ventilation. Do not use the equipment in draughty environments in order not to catch a cold.
 - Only use the equipment in environments with ambient temperatures between 10 °C and 35 °C. Only store the equipment in environments with ambient temperatures between 5 °C and 45 °C.
 - Do not use or store the equipment in humid surroundings. The air humidity must never be more than 80%.
 - Only use the equipment for its intended purpose. Do not use the equipment for other purposes than described in the manual.
 - Do not use the equipment if any part is damaged or defective. If a part is damaged or defective, contact your dealer.
 - Keep your hands, feet and other body parts away from the moving parts.
 - Keep your hair away from the moving parts.
 - Wear appropriate clothing and shoes.
 - Keep clothing, jewelry and other objects away from the moving parts.
 - Make sure that only one person uses the equipment at a time. The equipment must not be used by persons weighing more than 135 kg (300 lbs).
 - Do not open equipment without consulting your dealer.

Electrical safety (only for equipment with electric power)

- Before use, always check that the mains voltage is the same as the voltage on the rating plate of the equipment.
- Do not use an extension cable.
- Keep the mains cable away from heat, oil and sharp edges.
- Do not alter or modify the mains cable or the mains plug.
- Do not use the equipment if the mains cable or the mains plug is damaged or defective. If the mains cable or the mains plug is damaged or defective, contact your dealer.
- Always fully unwind the mains cable.
- Do not run the mains cable underneath the equipment. Do not run the mains cable underneath a carpet. Do not place any objects on the mains cable.
- Make sure that the mains cable does not hang over the edge of a table. Make sure that the mains cable cannot be caught accidentally or tripped over.
- Do not leave the equipment unattended when the mains plug is inserted into the wall socket.
- Do not pull the mains cable to remove the mains plug from the wall socket.

- Remove the mains plug from the wall socket when the equipment is not in use, before assembly or disassembly and before cleaning and maintenance.

Package contents (fig. B & C)

- The package contains the parts as shown in fig. B.
- The package contains the fasteners as shown in fig. C. Refer to the section “Description”.



NOTE

- If a part is missing, contact your dealer.

Description (fig. A)

Your crosstrainer is a piece of stationary fitness equipment used to simulate walking or running without causing excessive pressure to the joints.

1	Pedal	6	Support foot
2	Main housing	7	Support bar
3	Swivel handlebar	8	Console
4	Fixed handlebar	9	Transformer socket
5	Hand pulse sensor	10	Serialnumber label

Fasteners (fig. C)

11	Screw (M5*12)	20	Screw (M8*25)
12	Ring (M8)	21	Screw (M8*25)
13	Ring (M8)	22	Ring (M8)
14	Ring (ø27)	23	Ring (M5)
15	Screw (M8*56)	24	Ring (M5)
16	Nut (M8)	25	Ring (M8)
17	Screw (M8*20)	26	Ring (M8)
18	Screw (M8*15)	27	Screw (M5*12)
19	Screw (M5*15)		

Assembly (fig. D)



WARNING

- Assemble the equipment in the given order.
- Carry and move the equipment with at least two persons.



CAUTION

- Place the equipment on a firm, level surface.
- Place the equipment on a protective base to prevent damage to the floor surface.
- Allow at least 100 cm of clearance around the equipment.

- Refer to the illustrations for the correct assembly of the equipment.

Workouts

The workout must be suitably light, but of long duration. Aerobic exercise is based on improving the body's maximum oxygen uptake, which in turn improves endurance and fitness. You should perspire, but you should not get out of breath during the workout.

To reach and maintain a basic fitness level, exercise at least three times a week, 30 minutes at a time. Increase the number of exercise sessions to improve your fitness level. It is worthwhile to combine regular exercise with a healthy diet. A person committed to dieting should exercise daily, at first 30 minutes or less at a time, gradually increasing the daily workout time to one hour. Start your workout at low speed and low resistance to prevent the cardiovascular system from being subjected to excessive strain. As the fitness level improves, speed and resistance can be increased gradually. The efficiency of your exercise can be measured by monitoring your heart rate and your pulse rate.

Pulse rate measurement (hand pulse sensors)

The pulse rate is measured by sensors in the handlebars when the user is touching both sensors at the same time.

WARNING



- Heart rate monitoring systems may be inaccurate. Over exercise may result in serious injury or death. If you feel faint stop exercising immediately.

Most accurate pulse measurement is achieved when the skin is slightly moist and constantly touching the hand pulse sensors. If the skin is too dry or too moist, the pulse rate measurement might become less accurate.



NOTE

- Do not use the hand pulse sensors in combination with a heart rate chest belt.
- If you set a heart rate limit for your workout, an alarm will sound when it is exceeded.

Heart rate measurement (heart rate chest belt)

The most accurate heart rate measurement is achieved with a heart rate chest belt. The heart rate is measured by a heart rate receiver in combination with a heart rate transmitter belt. Accurate heart measurement requires that the electrodes on the transmitter belt are slight moist and constantly touching the skin. If the electrodes are too dry or too moist, the heart rate measurement might become less accurate.

**WARNING**

- If you have a pacemaker, consult a physician before using a heart rate chest belt.

**CAUTION**

- If there are several heart rate measurement devices next to each other, make sure that the distance between them is at least 2 meter.
- If there is only one heart rate receiver and several heart rate transmitters, make sure that only one person with a transmitter is within transmission range.

**NOTE**

- Do not use a heart rate chest belt in combination with the hand pulse sensors.
- Always wear the heart rate chest belt under your clothes directly in contact with your skin. Do not wear the heart rate chest belt above your clothes. If you wear the heart rate chest belt above your clothes, there will be no signal.
- If you set a heart rate limit for your workout, an alarm will sound when it is exceeded.
- The transmitter transmits the heart rate to the console up to a distance of 1,5 meter. If the electrodes are not moist, the heart rate will not appear on the display.
- Some fibers in clothes (e.g. polyester, polyamide) create static electricity which can prevent accurate heart rate measurement.
- Mobile phones, televisions and other electrical appliances create an electromagnetic field which can prevent accurate heart rate measurement.

Maximum heart rate (during training)

The maximum heart rate is the highest heart rate a person can safely achieve through exercise stress. The following formula is used to calculate the average maximum heart rate: $220 - \text{AGE}$. The maximum heart rate varies from person to person.

**WARNING**

- Make sure that you do not exceed your maximum heart rate during your workout. If you belong to a risk group, consult a physician.

Category	Heart rate zone	Explanation
Beginner	50-60% of maximum heart rate	Suitable for beginners, weight-watchers, convalescents and persons who have not exercised for a long time. Exercise at least three times a week, 30 minutes at a time.
Advanced	60-70% of maximum heart rate	Suitable for persons who want to improve and maintain fitness. Exercise at least three times a week, 30 minutes at a time.
Expert	70-80% of maximum heart rate	Suitable for the fittest of persons who are used to long-endurance workouts.

Use

Adjusting the support feet

The equipment is equipped with 6 support feet. If the equipment is not stable, the support feet can be adjusted.

1. Turn the support feet as required to put the equipment in a stable position.
2. Tighten the locknuts to lock the support feet.

**NOTE**

The machine is the most stable when all support feet are turned fully in. Therefore start to level the machine by turning all support feet fully in, before turning out the required support feet to stable the machine.

Console

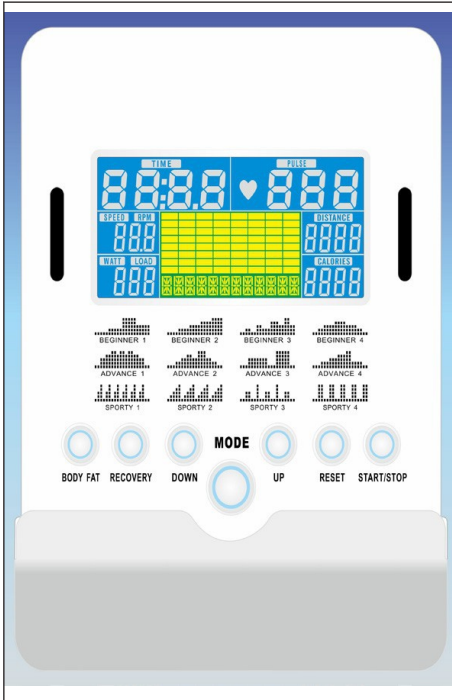

Explanation of the buttons

Button	Explanation
UP	Increase resistance level. Setting selection.
DOWN	Decrease resistance level. Setting selection.
MODE	Confirm setting or selection.
RESET	Hold on pressing for 2 seconds, computer will reboot and start from user setting. Reverse to main menu during presetting workout value or stop mode.
START / STOP	Start or Stop workout.
RECOVERY	Test heart rate recovery status.
BODY FAT	Test body fat% and BMI.

Explanation of menu items

Button	Explanation
TIME	Workout time displayed during exercise. Range 0:00 ~ 99:59
SPEED	Workout speed displayed during exercise. Range 0.0 ~ 99.9
DISTANCE	Workout distance displayed during exercise. Range 0.0 ~ 99.9
CALORIES	Burned calories during workout display. Range 0 ~ 999
PULSE	Pulse bpm displayed during exercise. Pulse alarm when over preset target pulse.
RPM	Rotation per minute. Range 0 ~ 999
WATT	Workout power consumption. In Watt Program mode, computer will remain preset watt value (setting range 0~350)
MANUAL	Manual mode workout.
PROGRAM	12 PROGRAM selection.
USER	User creates resistance level profile.
H.R.C.	Target HR training mode.

Power on

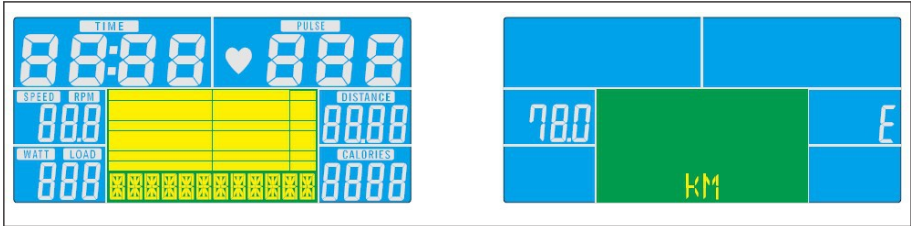

1. Plug in power supply, computer will power on and display all segments on LCD for 2 seconds.
2. After 4 minutes without pedaling or pulse input, console will enter into power saving mode.
3. Press any key may wake the console up.

Workout selection

1. Press UP / Down to select workout Manual, Beginner, Advance, Sporty, Cardio, Watt.

Manual mode



1. Press UP or DOWN to select workout program, choose Manual and press Mode to enter.
2. Press UP or DOWN to preset TIME, DISTANCE, CALORIES, PULSE and press MODE to confirm.
3. Press START/STOP keys to start workout. Press UP or DOWN to adjust load level.
4. Press START/STOP keys to pause workout. Press RESET to reverse to main menu.

Beginner mode



1. Press UP or DOWN to select workout program, choose Beginner mode and press Mode to enter.
2. Press UP or DOWN to preset TIME.
3. Press START/STOP key to start workout. Press UP or DOWN to adjust load level.
4. Press START/STOP key to pause workout. Press RESET to reverse to main menu.

Sporty mode

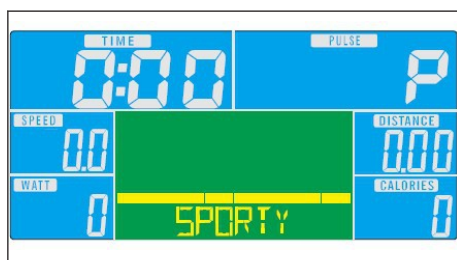

1. Press UP or DOWN to select workout program, choose Sporty mode and press Mode to enter.
2. Press UP or DOWN to preset TIME.
3. Press START/STOP key to start workout. Press UP or DOWN to adjust load level.
4. Press START/STOP key to pause workout. Press RESET to reverse to main menu.

Watt mode

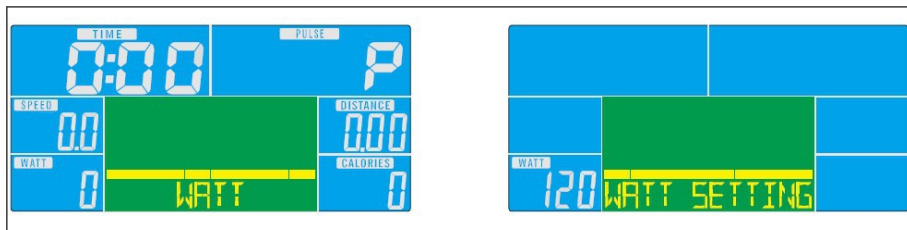

1. Press UP or DOWN to select workout program, choose WATT and press Mode to enter.
2. Press UP or DOWN to preset WATT target. (default: 120)
3. Press UP or DOWN to preset TIME.
4. Press START/STOP key to start workout. Press UP or DOWN to adjust Watt level.
5. Press START/STOP key to pause workout. Press RESET to reverse to main menu.

i-Console App

We have developed an App, which you can download on your 10" Tablet from the App Store (iOS: iPad) or Google Play (Android Market: Samsung, HTC, LG etc.). You only have to type TUNTURI and it will search and find the App. This gives you more possibilities to use our product in combination with your 10" Tablet.

To start the App, you have to connect your Tablet with Bluetooth and search for TUN-xxx (number)! The password you have to use to connect is 0000 (4 times zero).

“Made for iPad” means that an electronic accessory has been designed to connect specifically to iPad and has been certified by the developer to meet Apple performance standards. Apple is not responsible for the operation of this device or its compliance with safety and regulatory standards. Please note that the use of this accessory with iPad may affect wireless performance.

iPad is trademarks of Apple Inc., registered in the U.S. and other countries.

**NOTE**

- Once the console is connected to the tablet via Bluetooth, the console will power off.
- For iOS system, please exit the i-Console app and turn off the Bluetooth from iPad, then the console will power on again.

Start up

1. Press "Connect", the i-Console App will search for Bluetooth automatically.
2. Select the corresponding Bluetooth signal and start workout.



3. Before connect to Bluetooth, the user may change the settings in "System".
(Unit / Language / Password)

Workout selection



1. Press USER DATA SET to preset / edit / delete / select user.
2. Press QUICK START to start workout in Manual mode.
3. Press GUEST to start workout without preset user data.

User data set





1. Press USER DATA SET to preset / edit / delete / select user.

i-Route



1. After select user, the user may start workout with i-Route; PROGRAM; WATT; PROGRAM SUGGEST

Manual setting



1. Select MANUAL, preset TIME/ DIST/ CAL and press START button or BACK to reverse to previous setting.

Program setting



1. Select PROGRAM, may select PROGRAM1~12 and USER PROGRAM

i-Route setting

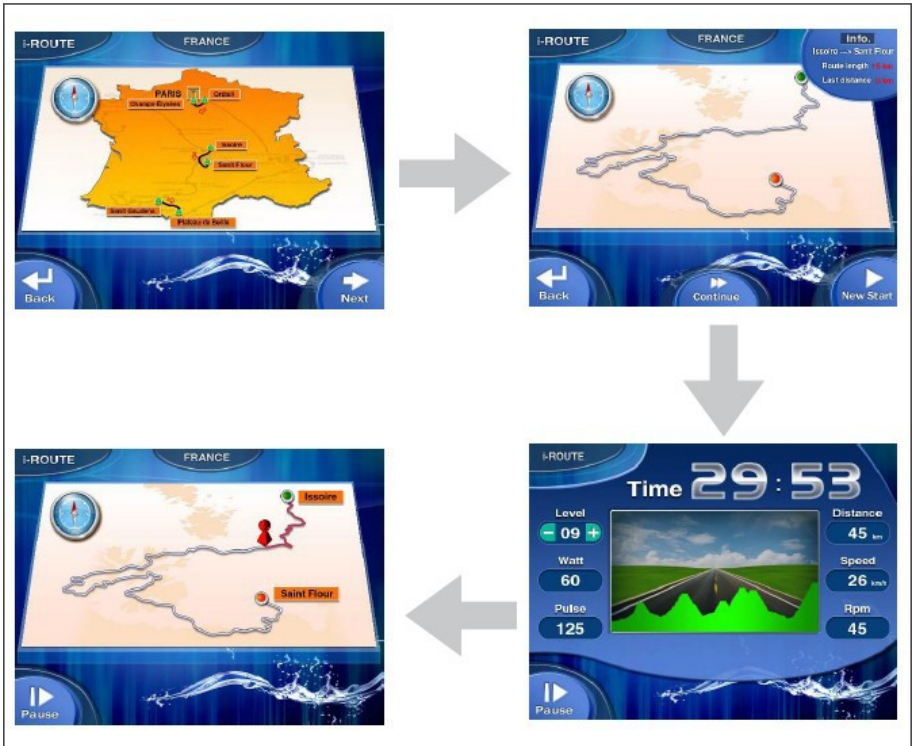

1. Select i-Route, the user may select country and corresponding route.

Watt setting



1. Select WATT and preset watt and time to start workout.

Cardio setting



1. Select CARDIO, and preset pulse and time to start workout.

Stop workout

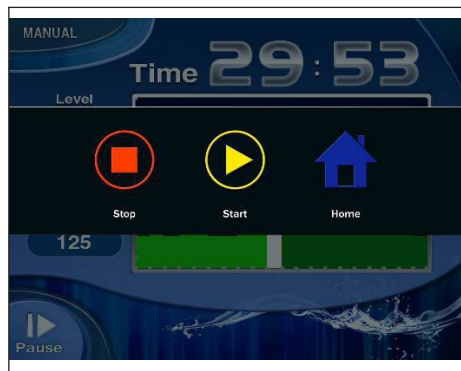

1. Press Stop to stop the workout.

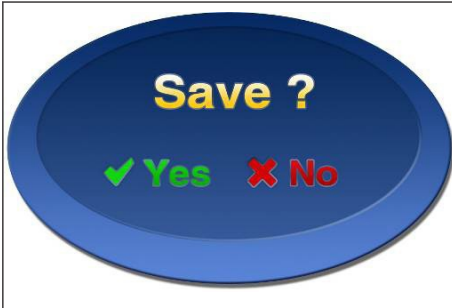

2. The user may save the workout or start a new workout by pressing Home

Workout summary

A workout summary is displayed at the end of the workout.



RANK			
	Name	Date/Time	Dist
1	Tommy	2011/12/25 18:30	2.7 Km
2	Sue	2011/12/30 07:30	2.1 Km
3	Alice	2011/12/12 08:00	1.8 Km
4			
5			
6			
7			
8			
9			
10			

Home Rank Workout

Cleaning and maintenance

Defects and malfunctions

Despite continuous quality control, defects and malfunctions caused by individual parts can occur in the equipment. In most cases, it will be sufficient to replace the defective part.

1. If the equipment does not function properly, immediately contact the dealer.
2. Provide the model number and the serial number of the equipment to the dealer. State the nature of the problem, conditions of use and purchase date.

Transport and storage



WARNING

- Carry and move the equipment with at least two persons.

1. Move the equipment carefully over uneven surfaces. Always carry the equipment by the handle bars and rear rail.
2. Store the equipment in a dry place with as little temperature variation as possible.

Technical data

Parameter	Unit of measurement	Value
Flywheel/Rotating mass		7kg/35kg
Power Output		260W/60RPM
Length	cm inch	179 71
Width	cm inch	71 28
Height	cm inch	166 66
Weight	kg lbs	74 163
Max. user weight	kg lbs	135 300
Adapter		9V/1.5A

Warranty

The product has a warranty from the date of delivery (to be documented by invoice or delivery note). Further information on warranty terms can be obtained from your local dealer. The warranty terms may vary from one country to another. Damages caused by normal wear, overloading or improper handling are excluded from the warranty. Damages caused by material or manufacturing faults are covered by the warranty and will be repaired or replaced at no cost.

Declaration of the manufacturer

Tunturi Fitness BV declares that the product is in conformity with the following standards and directives: EN 957 (HB), 73/23/EEC, 89/336/EEC. The product therefore carries the CE label.

10-2012

Tunturi Fitness BV
P.O. Box 60001
1320 AA Almere
The Netherlands

Disclaimer

© 2012 Tunturi Fitness BV
All rights reserved.

The product and the manual are subject to change. Specifications can be changed without further notice.

TUNTURI®

Tunturi Fitness BV

PO Box 60001

1320 AA Almere

The Netherlands

Tel: +31 36 5397102

Fax: +31 36 5460055

E-mail: Info@tunturi-fitness.com

For contact information and manuals in other languages, check our website:

www.tunturi.com