

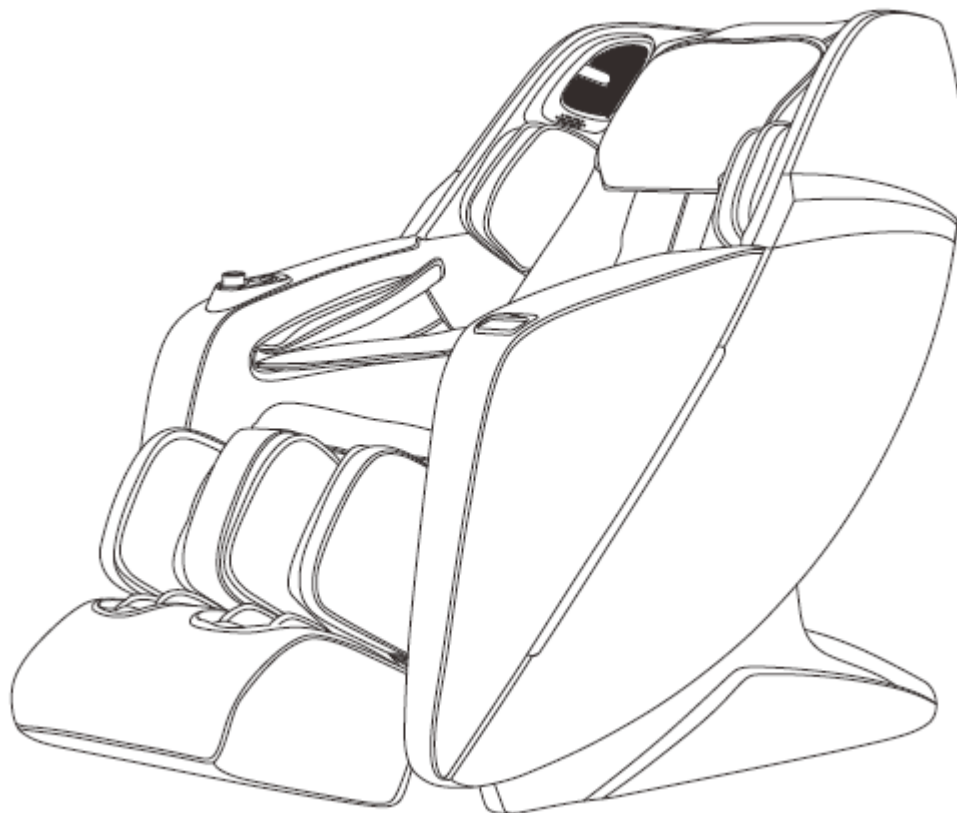

**USER MANUAL – EN**

**IN 23656 Massage chair inSPORTline Numana**



# CONTENTS

- SAFETY INSTRUCTIONS..... 3
- WARNING ..... 5
- PRODUCT DESCRIPTION ..... 6
- FUNCTIONS..... 7
- CONTROLLER ..... 8
- CONTROLLER BUTTONS..... 9
- USE ..... 10
  - POWER UP AND START-UP ..... 10
  - STANDBY MODE ..... 10
  - STARTING THE MASSAGE ..... 10
  - PAUSE ..... 11
  - MENU..... 12
  - MANUAL MODE ..... 13
  - SPEED, WIDTH AND INTENSITY ADJUSTMENT ..... 19
  - CUSTOM MESSAGE..... 21
  - SETTINGS ..... 22
  - ARMREST CONTROLLER..... 26
- VOICE CONTROL..... 27
- SWITCH OFF THE CHAIR..... 28
- BLUETOOTH..... 28
- ASSEMBLY ..... 28
  - ASSEMBLY OF ARMRESTS..... 28
  - LEG REST ASSEMBLY ..... 30
  - PILLOWS ..... 31
- FLOOR PROTECTION..... 32
- SPECIFICATIONS..... 32
- ENVIRONMENT PROTECTION ..... 33
- TERMS AND CONDITIONS OF WARRANTY, WARRANTY CLAIMS..... 33

# **SAFETY INSTRUCTIONS**

## **IMPORTANT SAFETY WARNINGS**

- Place the product on flat and solid surface and keep at least 0.6 m free space around the product.
- Kids can move around this product only under adult supervision.
- Use only well-grounded socket and proper power cord.
- Pull out the plug after every use or during maintenance to avoid injury or damaging the product.
- Please use this product according to the manual.
- Do not use unauthorized modifications or accessories.
- Only for indoor use.
- Before first use, please read the manual carefully.
- Use this product as is described in the manual.
- Recommended maximum use time is 20 minutes.
- Do not use the device if it is damaged. (frame, leather etc.)
- Do not use the chair if the ventilation is blocked.
- No not put on chair heavy items or objects with sharp edge.
- Do not fall asleep during massage for safety reasons.
- Do not use the chair after you consumed alcohol or other drugs or if you are sick or dizzy.
- Do not use within one hour after meal.
- Please be caution and do not use too strong massage.
- Weight limit: 150 kg

## **POSITION OF MASSAGE CHAIR**

- Do not use the chair in high temperatures or moist environments (e.g. bathroom).
- Do not use the chair immediately after temperature change.
- Do not use in dust or impropriety rooms.
- In is important to secure enough space and ventilation.

## **PEOPLE THAT SOULD NOT USE THE PRODUCT**

- People suffering from osteoporosis.
- People who have hearth problems or are using electronic medical equipment (e.g. peacemaker).
- People suffering fever.
- Pregnant women.
- People suffering skin diseases.
- Kids younger 14 years old or people suffering mental illness can use this product only under adult supervision.
- People that are recommended rest from the doctor or people suffering from sickness.
- Do not use this chair if you have wet body.
- Do not use the heat function if you are heat sensitive.

## **SAFETY**

- Maintenance should be done only by qualified person. User should not disassemble the chair or do the maintenance by themselves.
- After every use unplug the cord.
- Do not use the product if the power cord, plug or socket are damaged.
- If you are not using the chair for long period of time, store it at a clean and dry place and secure the power cord.
- Do not expose the chair to high temperatures, direct sunlight and do not place the chair near heat source.
- If the power cord, plug or socket are damaged, ask professional or qualified person for help.
- For cleaning use wet sponge only. Do not use thinner, gasoline or alcohol for cleaning.
- Mechanical parts are assembled and made to require minimum maintenance.
- Pay extra attention to not damage the chair with sharp objects.
- Do not push the chair on uneven ground, always pick the chair up and then move.
- Do not let the chair to work for long periods of time.

## **COMMON PROBLEMS AND SOLUTIONS**

- It is common that the motor is making sounds.
- If the chair is not working, please check the power cord, plug and socket and that the switch is ON.
- After the massage time is over the massage chair will turn OFF. The product will automatically shut down if it is overheated – wait at least half an hour before next massage.

## WARNING

If the footrest rises, do not apply pressure to the footrest. You may damage the product or injure yourself.

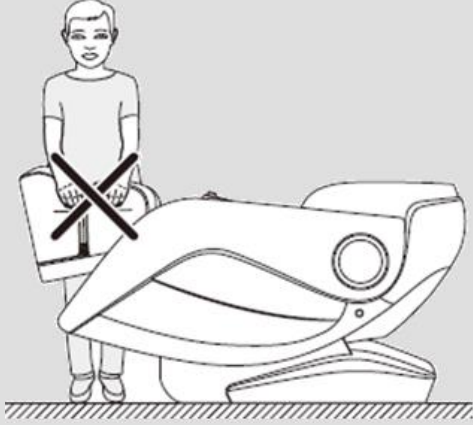

Before sitting down, make sure that the massage heads do not protrude from the seat. You may damage the heads or be injured.

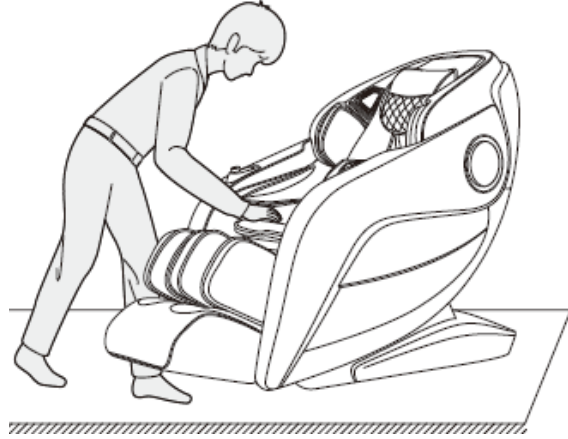

Never unplug the power cord during use or when the chair is in standby mode. After use, we recommend switching off the chair and unplugging the power cord.

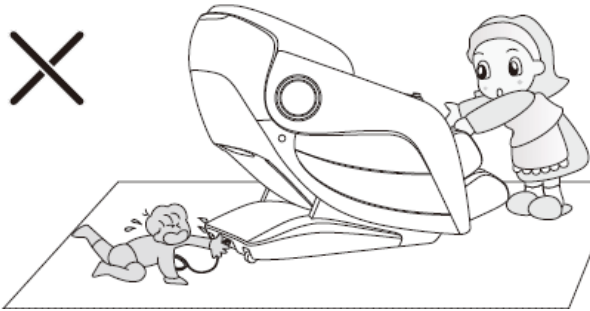

Before using the angle adjustment function, make sure that you have enough free space and that there are no other people or pets behind the chair.

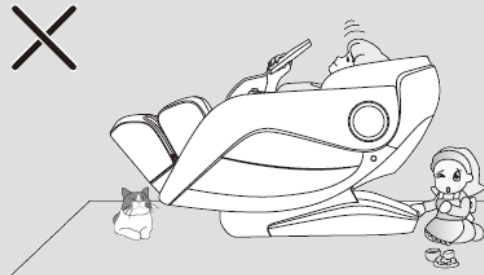

# PRODUCT DESCRIPTION

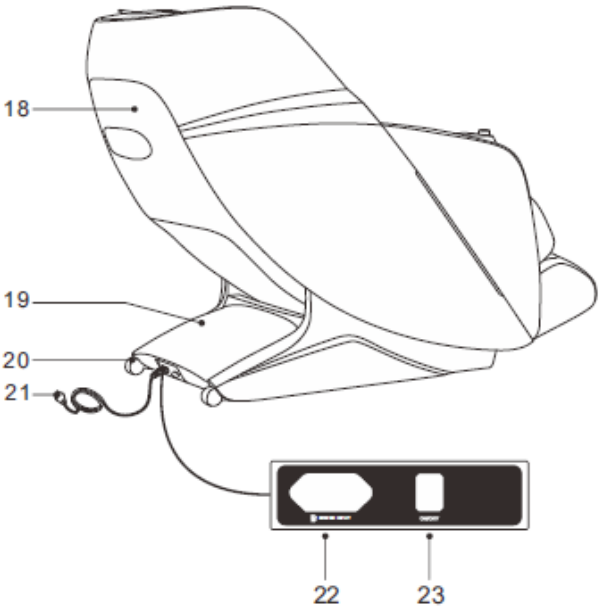
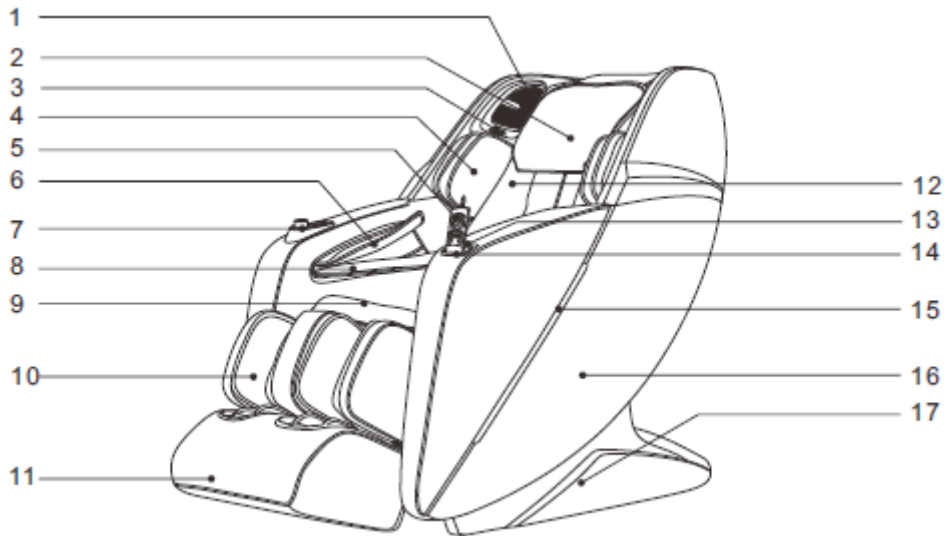

- 1. 3D digital speakers with voice control on the left
- 2. Pillow
- 3. Anion generator
- 4. Air cushions for upper arms
- 5. Controller
- 6. Air cushions for palms
- 7. Quick control
- 8. Massage magnetic tapes
- 9. Seat
- 10. Leg rest
- 11. Footrest
- 12. Backrest
- 13. USB charging port
- 14. Controller holder
- 15. LED lighting
- 16. Cover
- 17. Side covers
- 18. Backrest cover
- 19. Drive cover
- 20. Wheels
- 21. Power cord and plug
- 22. Device socket
- 23. Switch

## FUNCTIONS

- This product is designed with a set of massage heads that can move up and down in quiet operation.
- Five types of massages: Shiatsu, Kneading, Tapping, Knocking and simultaneous kneading and tapping.
- This product is equipped with automatic shoulder detection and positioning.
- There are eight special automatic massage functions: quick massage, comfortable massage, relaxation massage, stretching massage, full body massage, chiropractic massage, neck and shoulder massage and back and waist massage.
- Two saving slots for storing massages.
- Manual massage for the upper body; five massage position options (full range, local, fixed point, upper back and lower back), five massage techniques (shiatsu, kneading, tapping, knocking, simultaneous kneading and tapping). Five speed levels can be set for each massage technique; during the tapping, shiatsu and knocking massage you can set three levels of width of the massage heads.
- Airbag massage function available: upper arm airbag massage function (4 built-in airbags), arm airbag massage function (8 built-in airbags), leg massage airbag function (6 built-in airbags) and foot airbag massage function (22 built-in airbags); there are three levels of air pressure intensity for the setting.
- The chair supports 3 levels of heating with carbon fiber.
- The backrest is sliding inside to minimize the space required.
- The backrest is ergonomically adapted.
- 3D audio system for playing music via Bluetooth.
- Voice control.
- Buttons for quick operation are located on the right armrest.
- The chair supports independent adjustment of the backrest and footrest, connected adjustment of the inclination of the backrest and leg rest, zero gravity and timer.
- The chair supports adjusting the length of the footrest.
- The chair contains foot massage rollers.
- For palm massage, air cushions contain magnetic tapes.
- The chair supports the kneading of the legs.
- USB charging in the holder for the controller.
- Anion generator.
- Controller with TFT color display.
- Shutdown, automatic shutdown, restart.
- The headrest cushion contains two layers.

## CONTROLLER

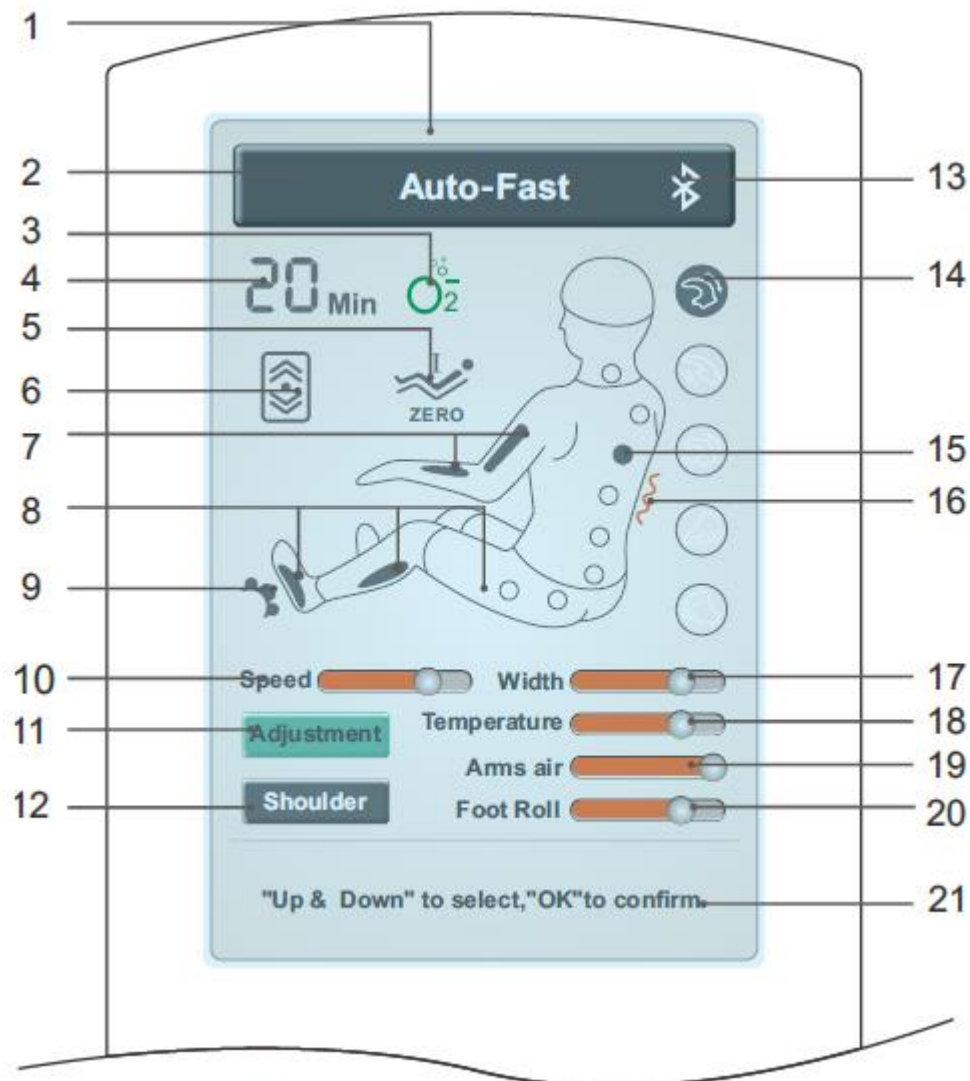

1.	TFT color LCD display	12.	Adjusting the position of the shoulders
2.	Type of massage	13.	Bluetooth
3.	Anion generator	14.	Type of massage
4.	Timer	15.	Massage location
5.	Zero gravity	16.	Back and leg heating
6.	Massage of the back	17.	Width adjustment
7.	Arm cushion pressure	18.	Massage intensity
8.	Leg rest pressure	19.	The intensity of the air cushions of the arms
9.	Foot massage rollers	20.	Intensity of lower body air cushions
10.	Speed setting	21.	Information
11.	Adjustment		



## CONTROLLER BUTTONS

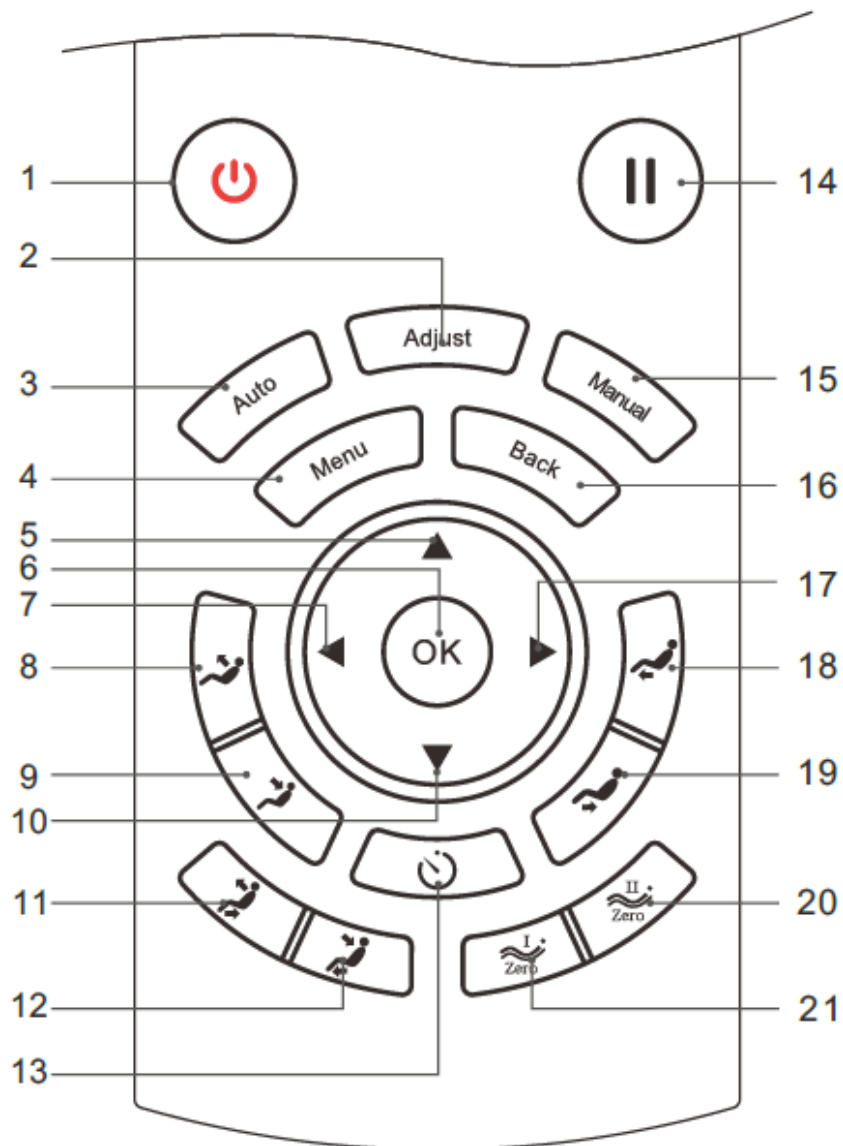

1. Switch	12. Lowering the backrest and raising the leg rest
2. Edit button	13. Time setting
3. Automatic massage	14. Pause
4. Menu	15. Manual mode
5. Navigation key up	16. Return button
6. Confirm button	17. Right navigation button
7. Navigation key left	18. Lifting the leg rest
8. Raising the backrest	19. Lowering the leg rest
9. Lowering the backrest	20. Switching to zero gravity I
10. Navigation key down	21. Switching to zero gravity II
11. Raising the backrest and lowering the leg rest	

# USE

## POWER UP AND START-UP

1. Plug in the socket

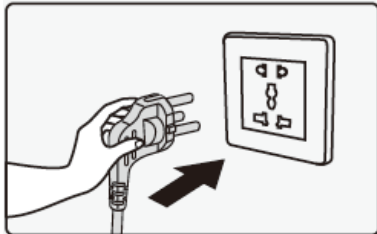

2. Plug in the chair

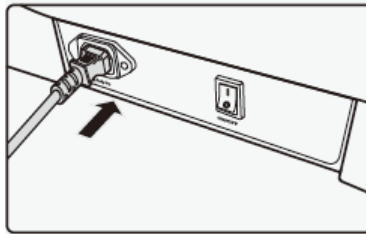

3. Turn the switch up

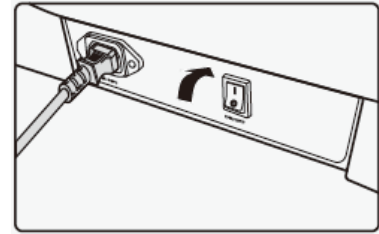

## STANDBY MODE

No function can be selected in standby mode.

## STARTING THE MASSAGE

Press the chair switch to start. The back and leg rests are adjusted to their default position.

After sitting, the chair automatically detects the position of the shoulders and body. Wait until detection is complete, or press "OK" to skip detection. After starting the automatic massage, the massage starts with preset values.

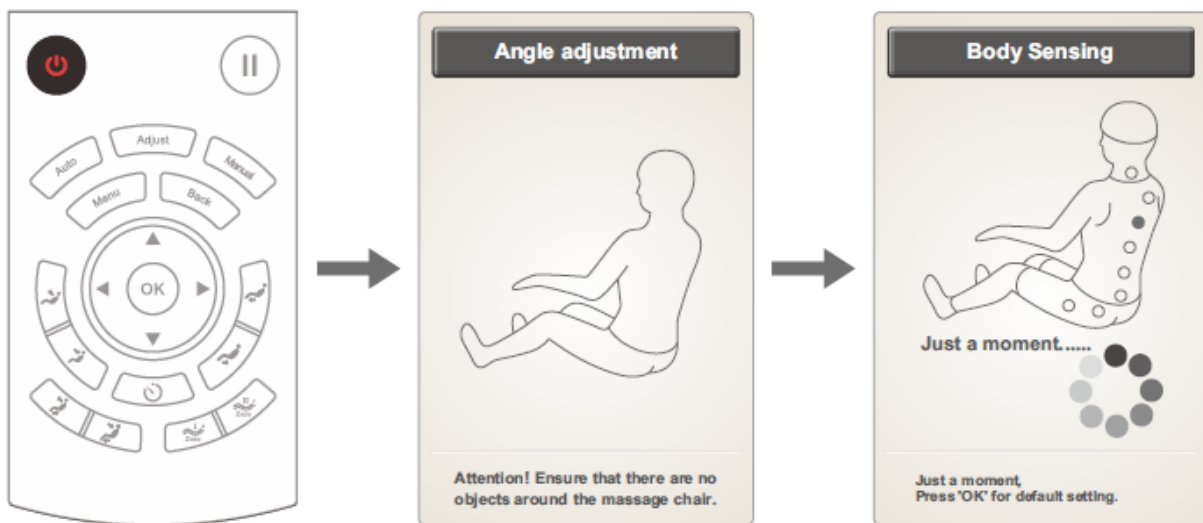

An audible signal sounds when the shoulder detection is complete. You can adjust the position of the shoulder massage heads manually using the "UP" and "DOWN" buttons. You can set up to 11 positions of the massage heads. If the position of the shoulders is not adjusted within 10 seconds, the massage will start automatically. You can skip the settings by pressing "OK". If the position of the arms cannot be detected, the automatic massage starts with preset values.

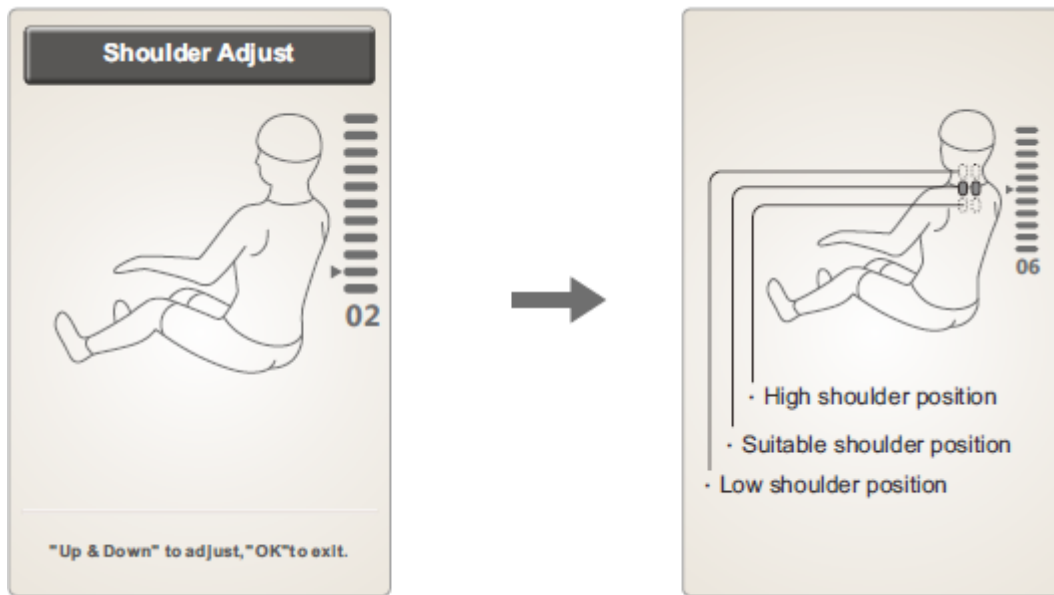

Button	Description
--------	-------------



Moves the shoulder massage head up

Moves the massage head of the shoulders down

In the interface below, you can select "Adjustment" or "Shoulder" to adjust the heads. Then confirm the adjustment by pressing "OK".

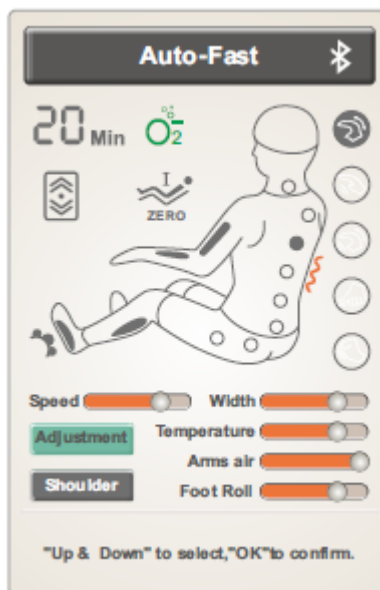

## PAUSE

If the massage is running, you can pause the massage by pressing "pause". Press "pause" repeatedly to start the massage again. If the pause is longer than 20 minutes, the massage will automatically switch off.

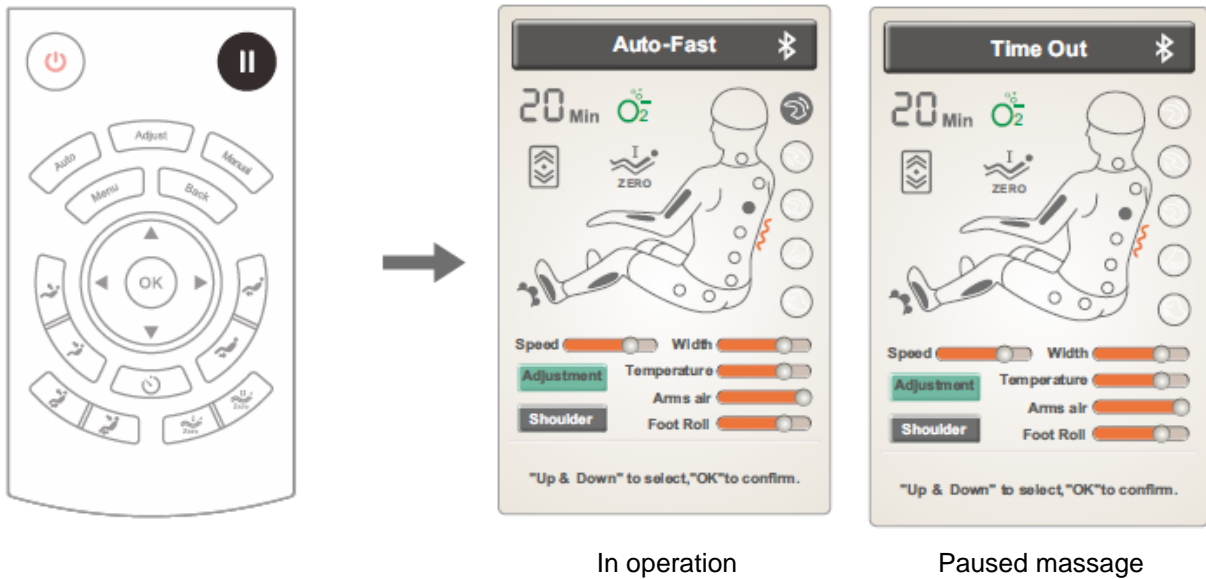

## MENU

Press "menu" to enter the main menu, in the main menu you can select "auto" automatic massage, "manual" manual massage, "adjustment" adjustment, "customize" to adjust, "setting" settings, device information "device information".



## AUTOMATIC MASSAGE

You can select an automatic massage via the main menu "menu" or via the "auto" button, which will take you to the automatic massage interface.

Types of automatic massages: "Fast massage" fast, "Comfortable massage" comfortable, "Relax massage" relaxation, "Stretch massage" stretching, "Full body massage" full body massage, "Chiropractic massage" chiropractic massage, "Neck & shoulder massage" neck and shoulder massage, "Back & waist massage" back and waist massage.

Navigate in the menu using the "up" and "down" buttons, confirm the free time by pressing "Ok". Press "Back" to return to the previous menu.

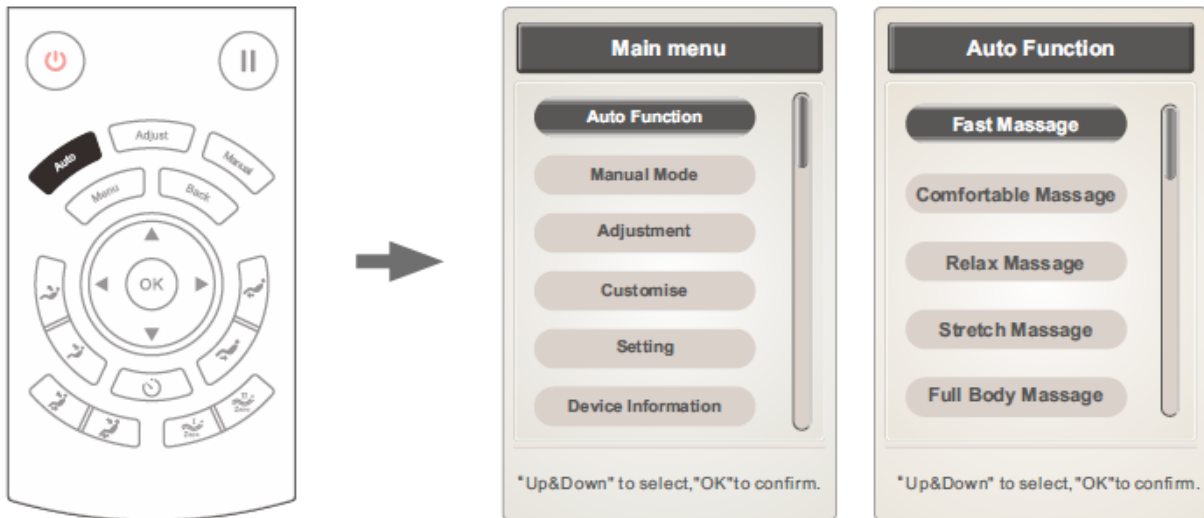

Function	Description
Fast massage	Quick massage
Comfortable massage	Comfortable massage
Relax massage	Gentle and comfortable full body massage for relaxation
Stretch massage	Stretching the legs, waist and back to restore energy
Full body massage	Deep full body massage
Chiropractic massage	Chiropractic massage for body relaxation
Neck & shoulder massage	Special neck and shoulder massage
Back & waist massage	Special back and waist massage

Note: The selected function is displayed in the information bar, you can press "Back" to display the progress.

## MANUAL MODE

Press "Menu" to enter the main menu, select "manual".

You can set: "Massage technique" massage technique, "Massage part" instead of massage, "Airbag massage" massage with air cushions, "Other massage functions" other functions.

Use the "Left" and "Right" buttons to enter the function settings, use the "Up" and "Down" buttons to move in the menu. Press "Back" to return to the main interface.

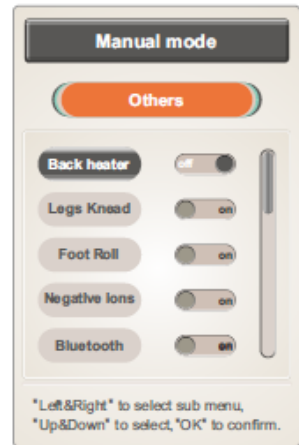
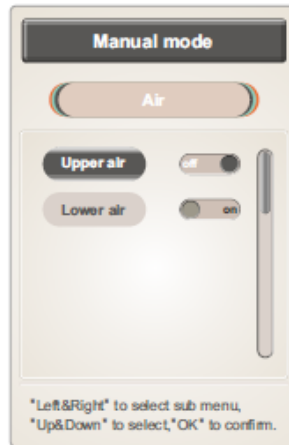
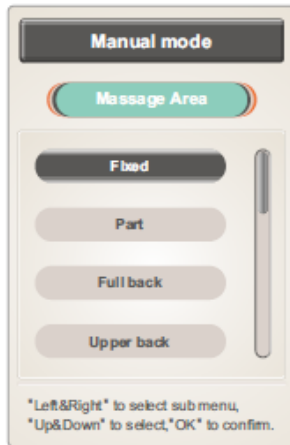
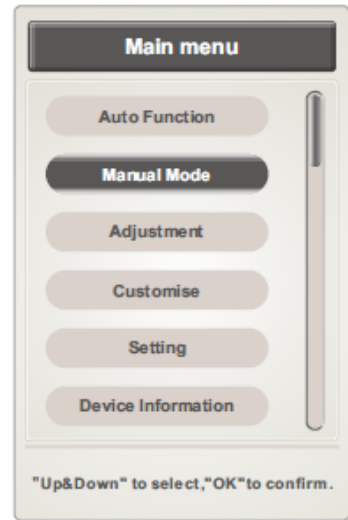
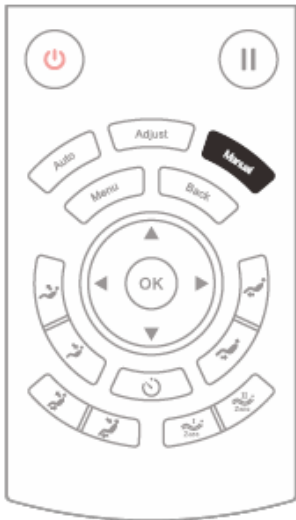

**MANUAL MODE - SELECTION OF MESSAGE TYPE**

Techniques: "Kneading" kneading, "Tapping" tapping, "Kneading and tapping" kneading and tapping, "Shiatsu" and "tapping". In Shiatsu and tapping mode, you can adjust the width of the massage heads.

Use the "Up" and "Down" buttons to select the technique, confirm with "Ok".



Note: Press "Stop" to stop all functions

Function	Settings
Kneading	Speed
Tapping	Speed and width
Kneading and tapping	Speed
Shiatsu	Speed and width
Knocking	Speed and width

5 speed levels  
3 width levels

### MANUAL MODE - SELECTING THE MASSAGE LOCATION

Fixation in one place, partial, whole back, upper and lower back.

Use the up and down buttons to select the type, confirm by pressing "ok".

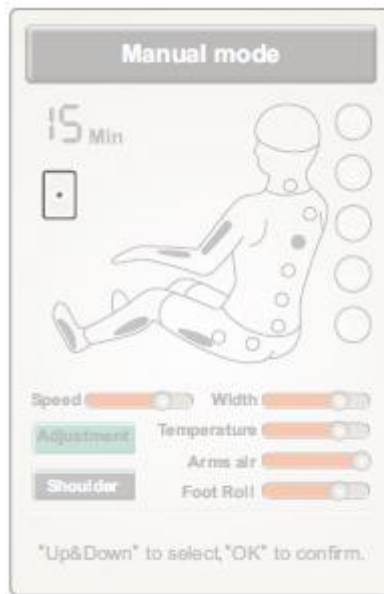
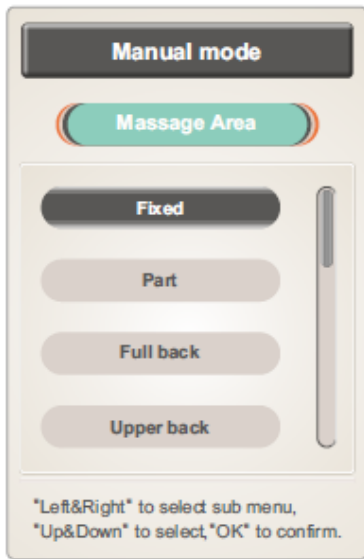

Fixed



Partial

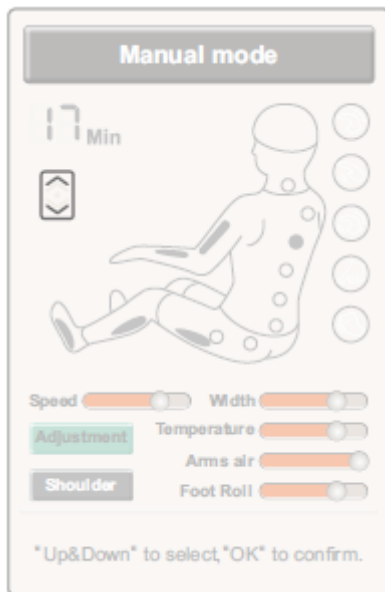

Whole back

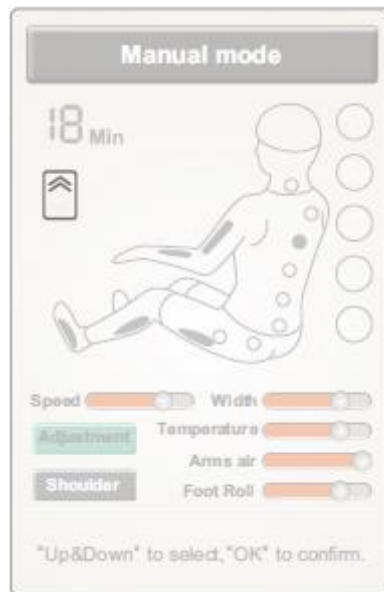

Upper back



Lower back

Function	Description
In one place	Massage in one place
Partial	Partial massage on a small scale
Upper back	Upper back massage
Lower back	Lower back massage
Whole back	Total massage

In these modes, use the up and down buttons to select a range

### Air cushions

Upper or lower limb air cushions

Use the up and down buttons to select the function, confirm by pressing "ok".

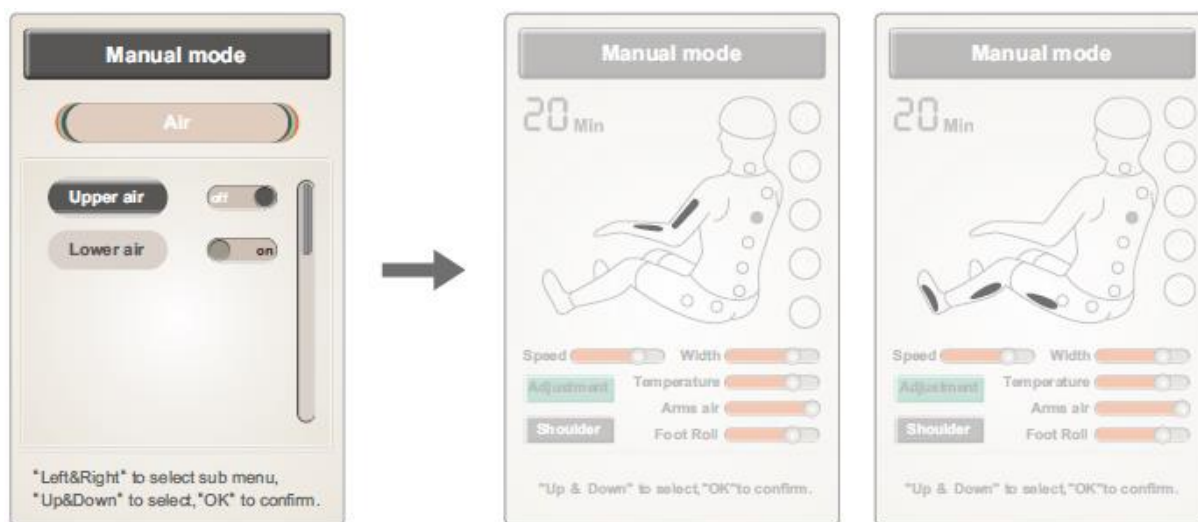

Function	Description
Upper limbs	Turn on or turn off the function
Lower limbs	Turn on or turn off the function

### Other functions

Heating, kneading of legs, foot massage rollers, anion production, Bluetooth.

Use the up and down buttons to select the function, confirm by pressing "ok".

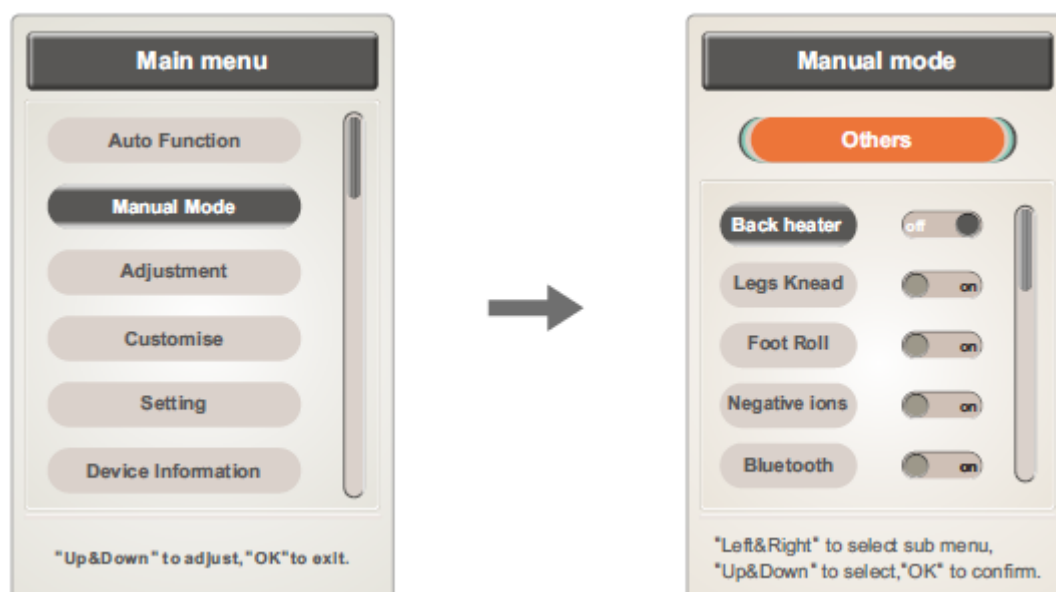



Use the up and down buttons to select the function, confirm by pressing "ok".

Press "confirm" to start / stop heating.

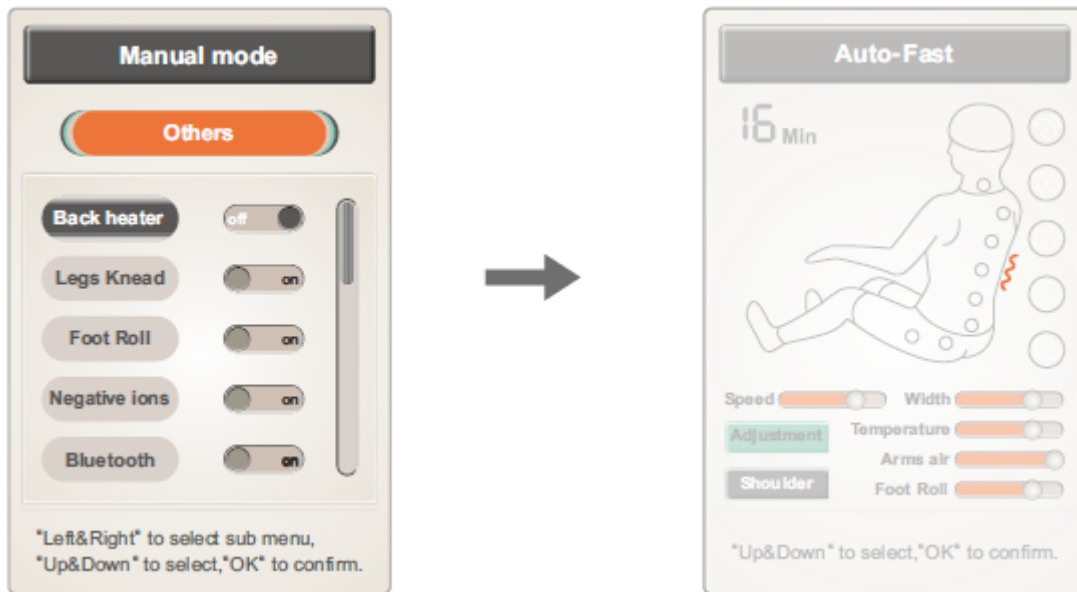

Use the up and down buttons to select the function, confirm by pressing "ok".

Press "confirm" to start / stop kneading the legs.

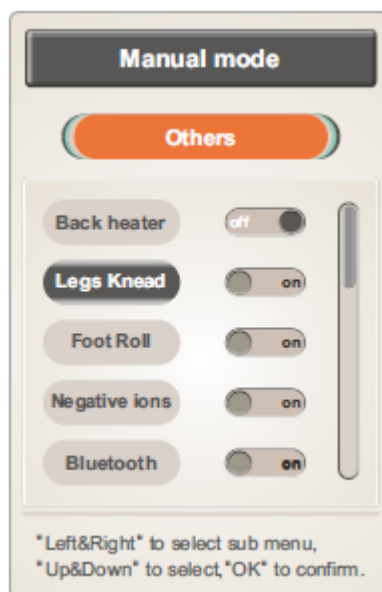

Use the up and down buttons to select the function, confirm by pressing "ok".

To start / stop foot massage, press "confirm".

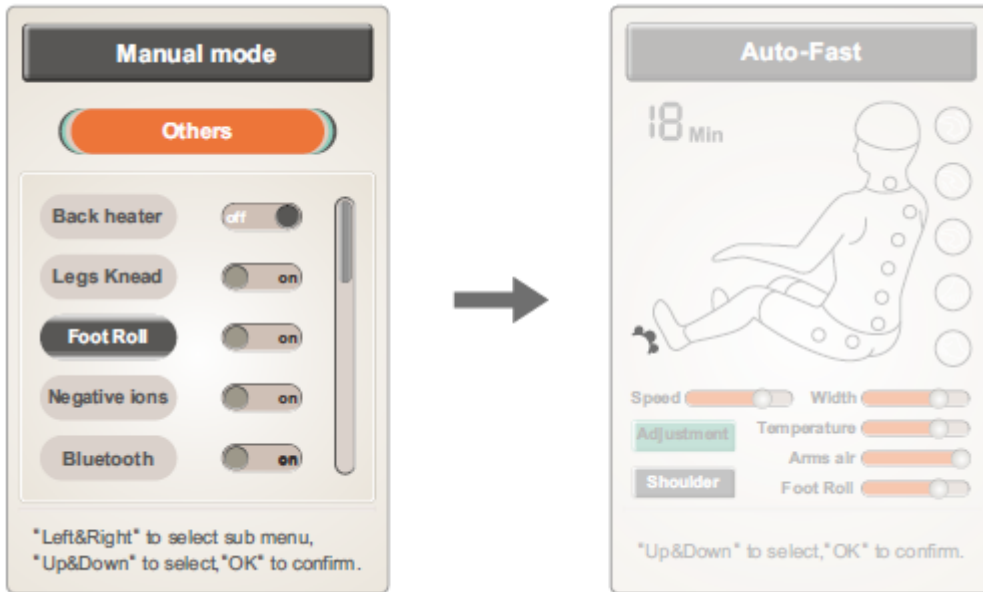

Use the up and down buttons to select the function, confirm by pressing "ok".

To start / stop anion generation, press "confirm".

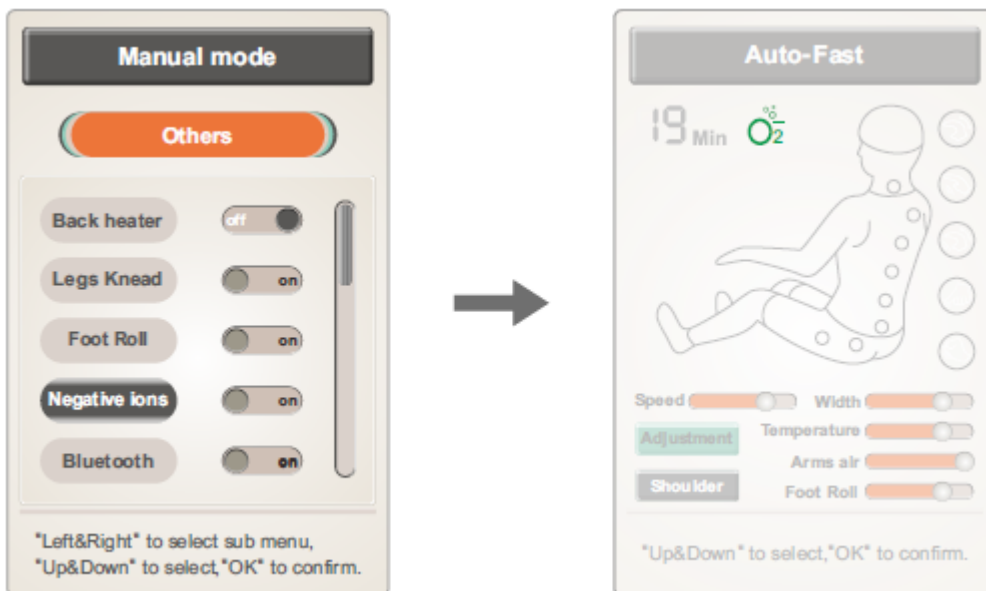

Use the up and down buttons to select the function, confirm by pressing "ok".

Press "confirm" to turn Bluetooth on / off.

You can use Bluetooth to play music.

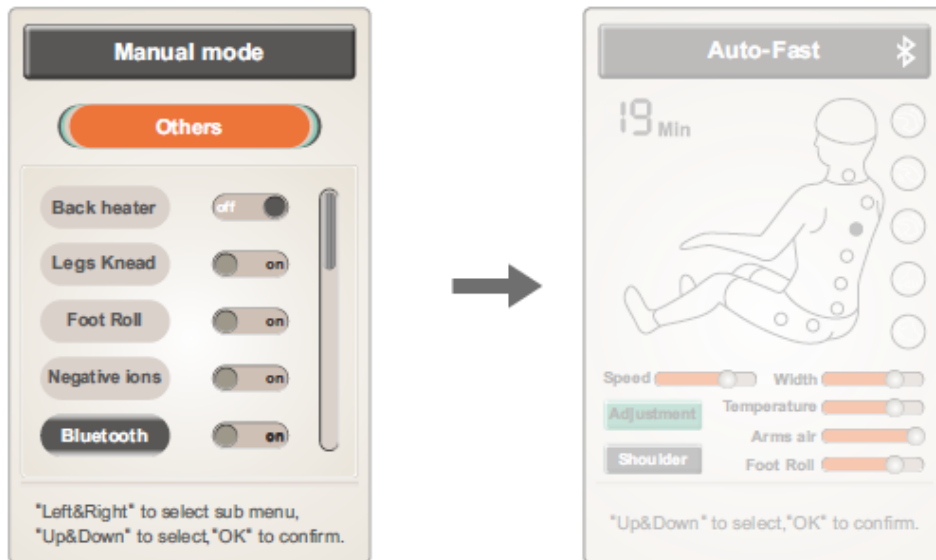

## SPEED, WIDTH AND INTENSITY ADJUSTMENT

In the main menu, select "adjustment"

An interface appears where you can select a function by pressing the up and down buttons and adjust their value by pressing the right and left buttons. After setting, confirm by pressing "ok" or return to the menu without changes by pressing "back"

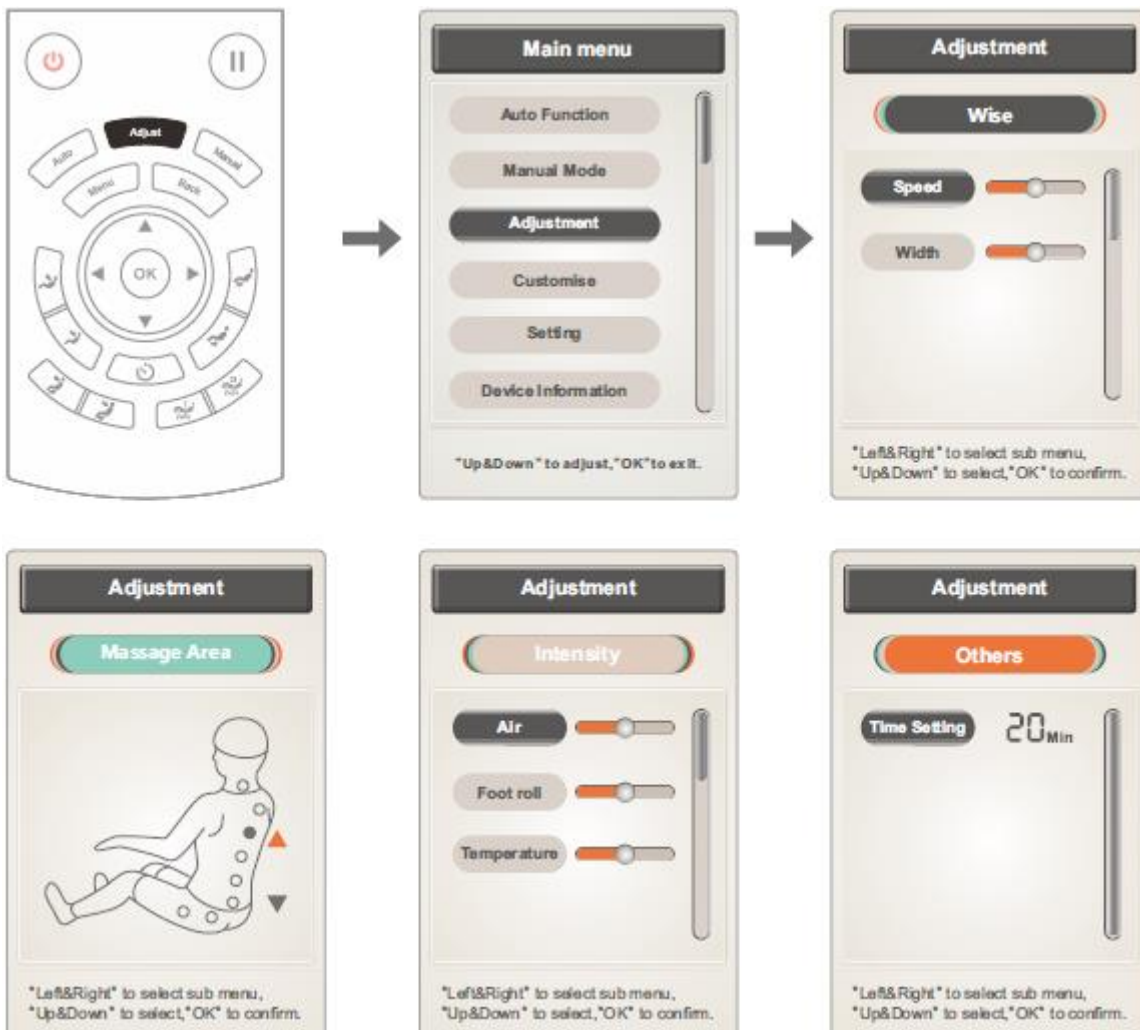

## SPEED AND WIDTH

You can adjust the speed and width of the massage heads.

Navigate in the menu using the Up and Down buttons, confirm the selection by pressing "Ok".

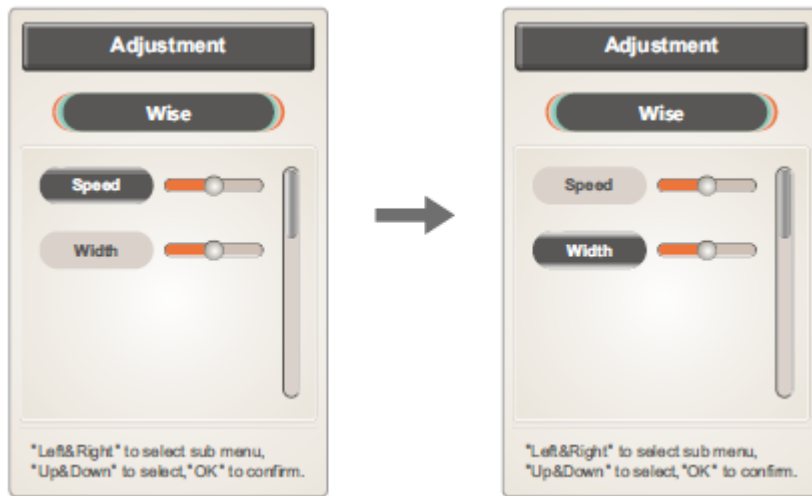

Note: 5 speed levels can be set and for tapping, Shiatsu and knocking massages, 3 levels of shoulder massage head width can be set.

## PLACE / SCOPE OF MESSAGE

You can set the place or range of the massage in single place message or partial message modes.

You can adjust the range using the up and down buttons.

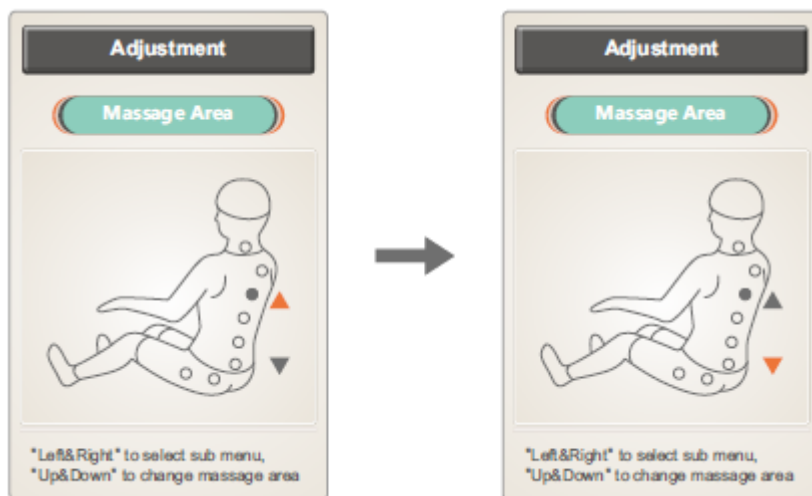

## INTENSITY

The chair supports 5 levels of massage intensity with air cushions and foot rollers.

The chair supports 3 levels of heating.

Use the up and down buttons to select the function, adjust the value by pressing right and left, confirm by pressing "ok"

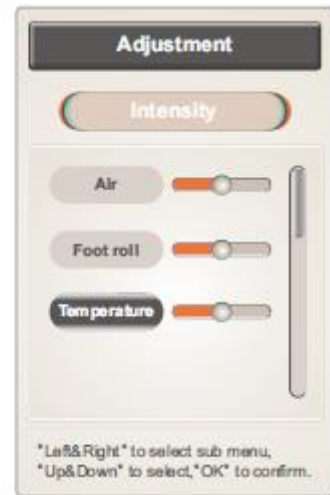
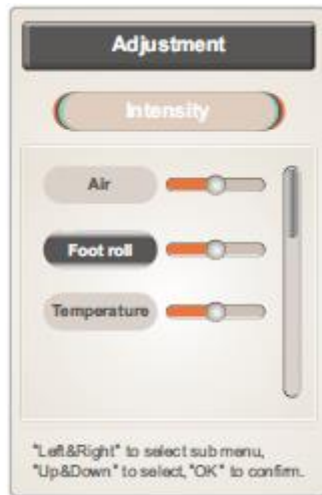
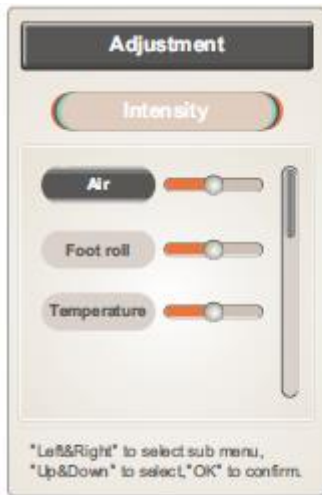

## OTHER

Adjust the operating time, press "ok" to add 5 minutes. After adding more than 40 minutes, the time is reset. The minimum operating time must be 5 min.

Confirm the time by pressing "confirm".

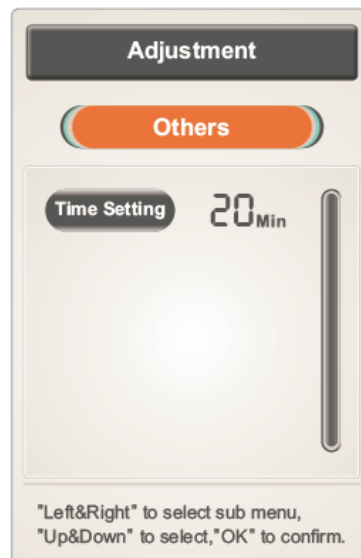

## CUSTOM MESSAGE

Press "menu" and select "customize". An interface with 2 positions for saving the message is displayed.

Use the right and left buttons to select whether you want to save or load the settings. Confirm by pressing "ok".

Navigate in the interface using the up and down buttons.

Storage: save settings - type of massage, air cushion pressure, angle and more.

Transfer: upload settings - type of massage, air cushion pressure, angle and more.

Press "back" to return to the menu.

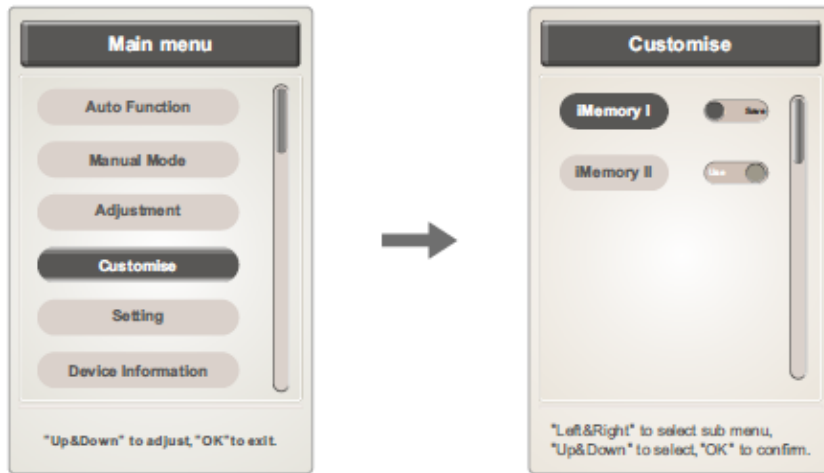

## SETTINGS

Press "menu" and select "setting" to set the language, backlight, display power saving, etc.

In the menu, use the up and down buttons to navigate, and to change the value of the right and left buttons.

Press "back" to return.

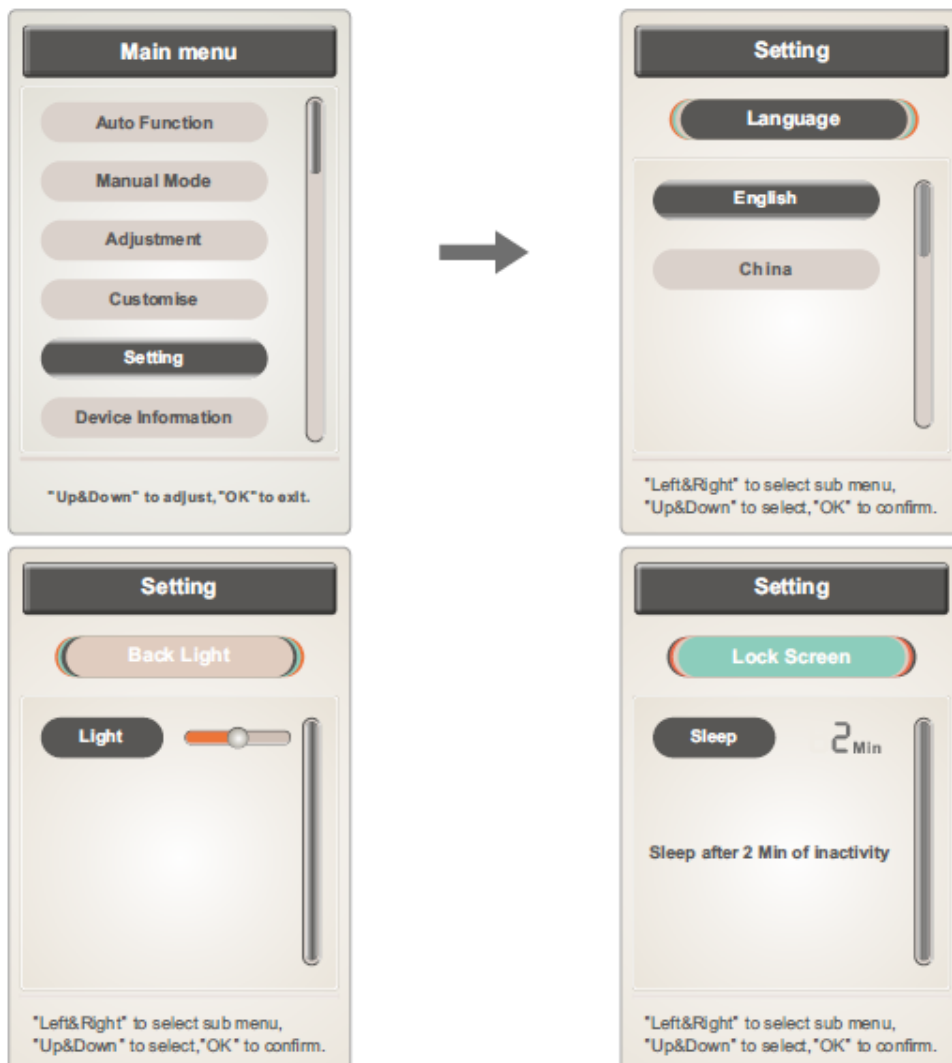

## LANGUAGE

Language: select English or China

In the menu, use the up and down buttons to navigate.

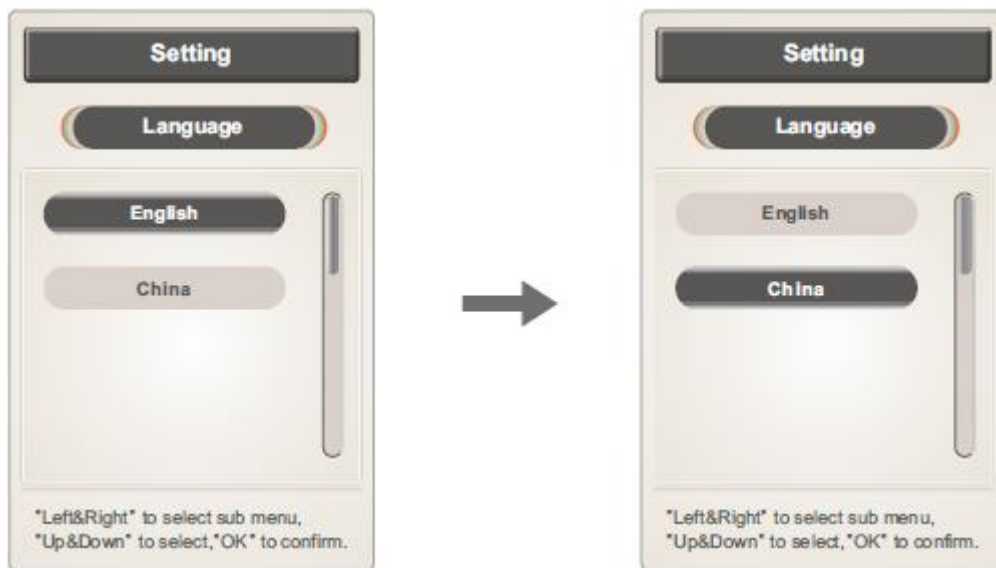

## DISPLAY POWER SAVING

Lock screen: you can set the time, never turn off the screen, or automatically turn off the display after 2 seconds of inactivity.

To adjust the time, press "ok", you can set 15 seconds, 30 seconds, 1 min, 2 min, 3 min or never switch off.

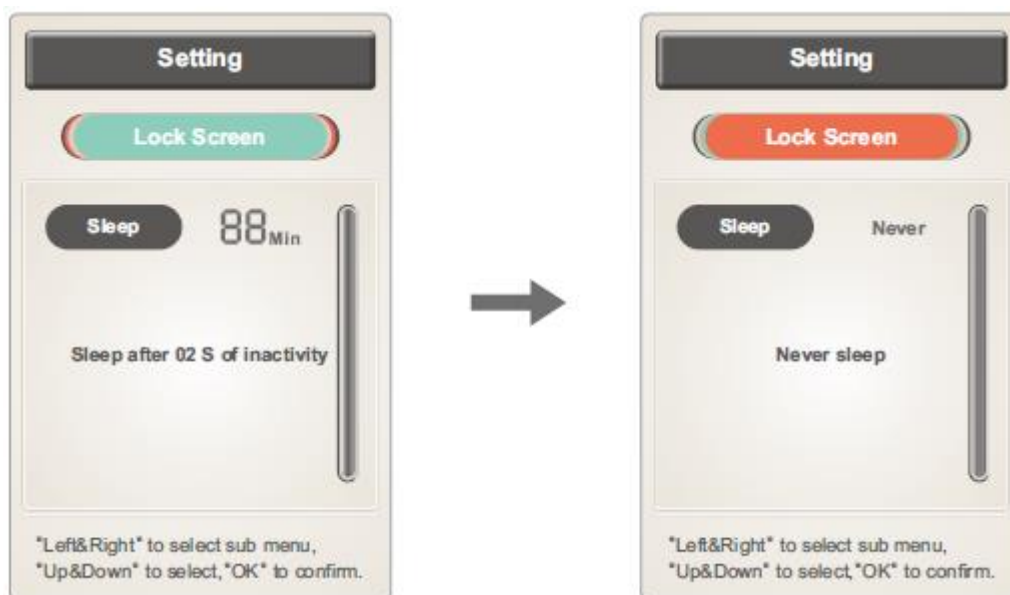

## BACKLIGHT

You can set 5 levels of backlight.

Press "back" to return to the main menu.



## DEVICE INFORMATION

Press "menu" and select "Device information"

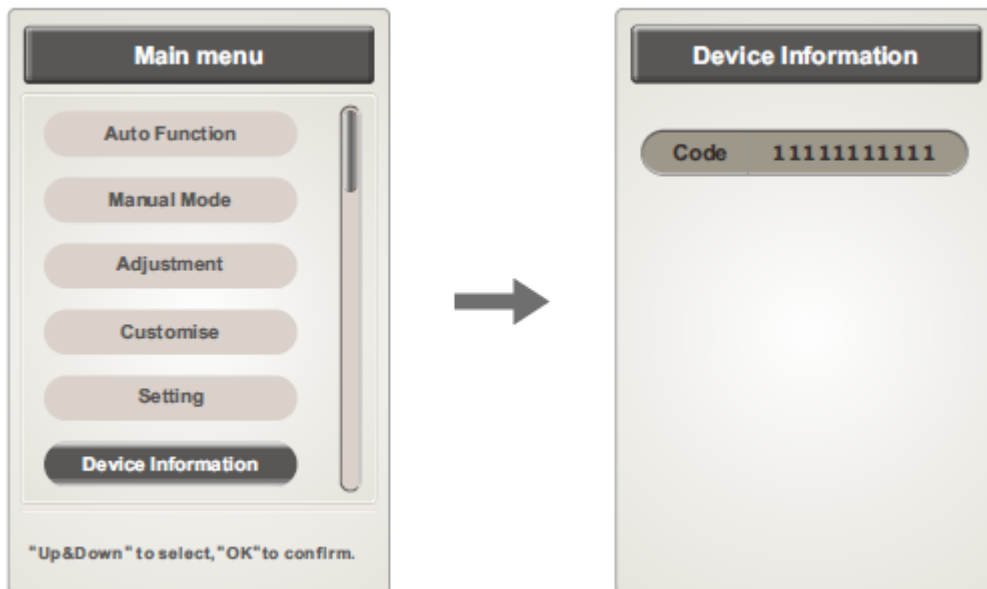



## ZERO GRAVITATION SETTING

Press Zero I or Zero II

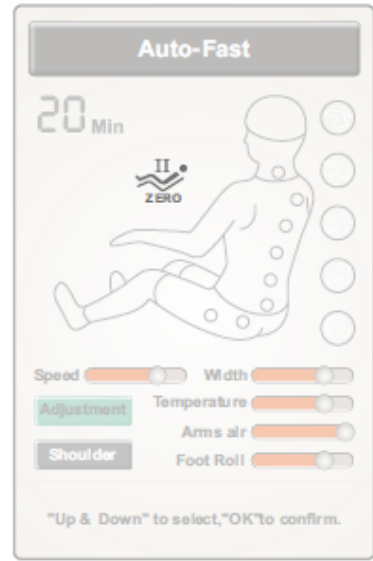
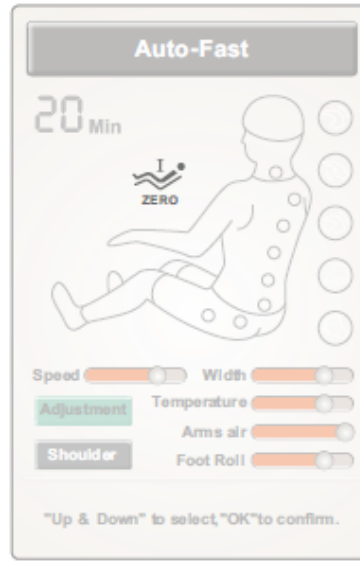
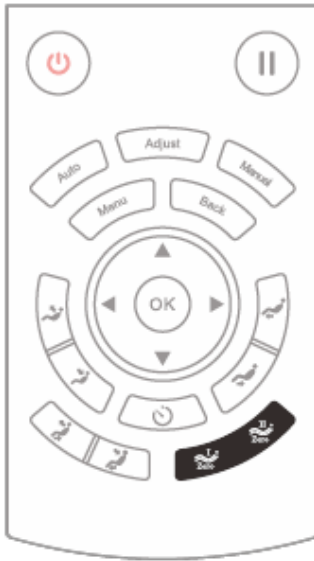

### Funkce

### Popis



Zero gravity I: vybrání náklonu I









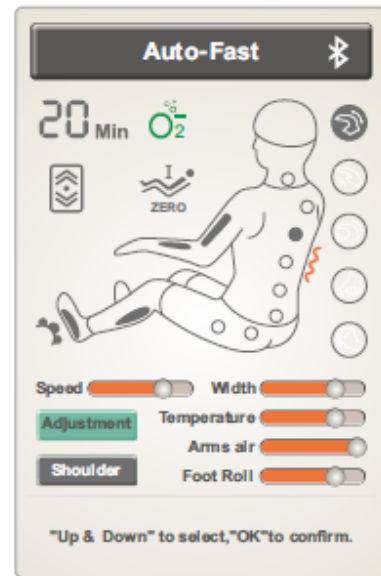
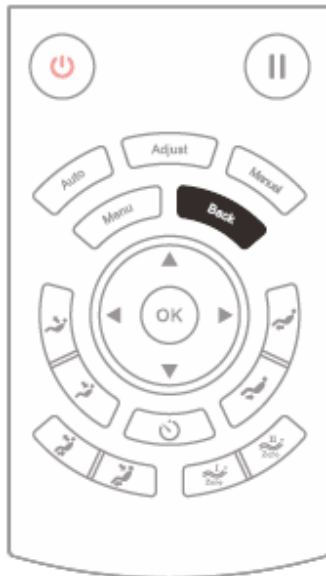

Zero gravity II: vybrání náklonu II

## BACK BUTTON

The "back" button is used to display information about the massage.



## ADJUSTING THE ANGLE OF THE RESTS

Function	Description
	To raise the footrest: hold for lifting, release the button to stop. When done, it automatically detects the length of the legs.
	Lowering the footrest: hold to lower, release the button to stop. When done, it automatically detects the length of the legs.
	To raise the armrest: hold to lift, release the button to stop.
	Lowering the backrest: hold to lower, release to release to stop.
	Raise the backrest and lower the footrest, release the button to stop.
	Lowering the backrest and raising the footrest, release the button to stop.
	Zero gravity I
	Zero gravity II
	Setting the operating time, each press increases the time by 5 min, the total time must not exceed 40 min, otherwise the value is reset to the lowest possible value.

## ARMREST CONTROLLER

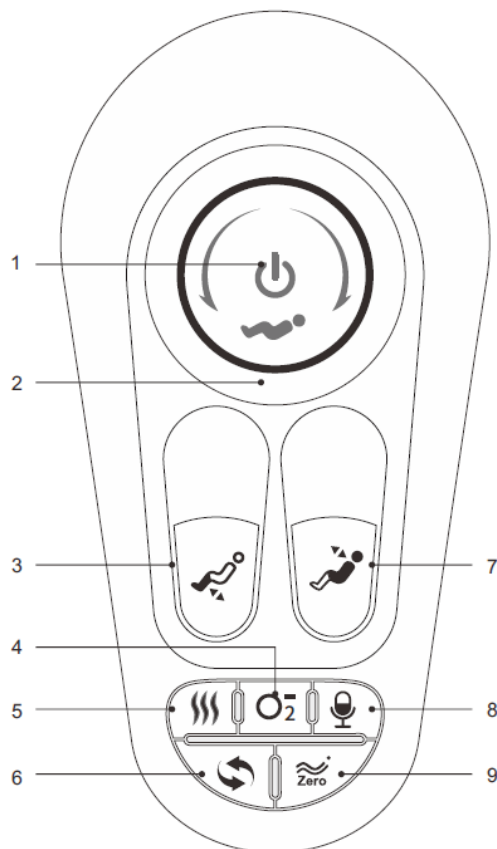

1. Power button: press to turn the chair on / off

2. Linked change of back and leg support

3. Adjusting the height of the leg rest

4. Anion generation: press to turn on / off









5. Heating: press to switch on / off

6. Automatic massage: press to switch on / off

7. Adjusting the angles of the back rest

8. Voice control: press to turn on / off

9. Zero gravity angle settings

Function	Description
	Power button: press to pause / start the massage, hold for 3 seconds to start / stop the chair. If the pause is longer than 20 minutes, the chair switches off automatically.
	Turning clockwise will lower the backrest and raise the footrest
	Turning counterclockwise will raise the backrest and lower the footrest
	To raise the leg rest: hold down the button to change, release the button to stop
	Lowering the leg rest: hold down the button to change, release the button to stop
	Raising the armrest and lowering the footrest: hold down the button to change, release the button to stop
	Lowering the backrest and raising the footrest: hold down the button to change, release the button to stop
	Start or stop heating
	Start or stop ionization
	Start or stop voice control of the chair
	Start or stop the automatic massage
	Zero gravity position setting. Two positions.

## VOICE CONTROL

Voice control of the chair is in English only.

If the chair is turned on or in standby mode, say "Hi Alice" to start voice control. After starting the voice control, you have 6 seconds to enter the next command. After 6 seconds, the voice control switches off again.

No.	Command	Answer
1.	Massage on	ok, massage on.
2.	Massage close	ok, massage close
3.	Comfort Massage.	ok, comfort massage
4.	Relax massage.	ok, relax massage
5.	Full body massage.	ok, full body massage
6.	Neck and shoulder massage.	ok, Neck and shoulder massage
7.	Back and waist massage.	ok, back and waist massage
8.	Stretch massage.	ok, stretch massage
9.	Fixed massage.	ok, fixed massage
10.	Change the other mode.	ok, change the other mode
11.	Go little down.	ok, go little down
12.	Go little up.	ok, go little up

- |     |                         |                            |
|-----|-------------------------|----------------------------|
| 13. | Open the air pressure.  | ok, open the air pressure  |
| 14. | Close the air pressure. | ok, close the air pressure |
| 15. | Up the seat position.   | ok, up the seat position   |
| 16. | Down the seat position. | ok, down the seat position |
| 17. | Stop adjustment.        | ok, stop adjustment        |

## SWITCH OFF THE CHAIR

Press the power button to turn off the chair. The massage functions are switched off, the positions of the armrests are switched to the default positions.

To switch off completely, switch the switch on the left side of the chair to the off position.

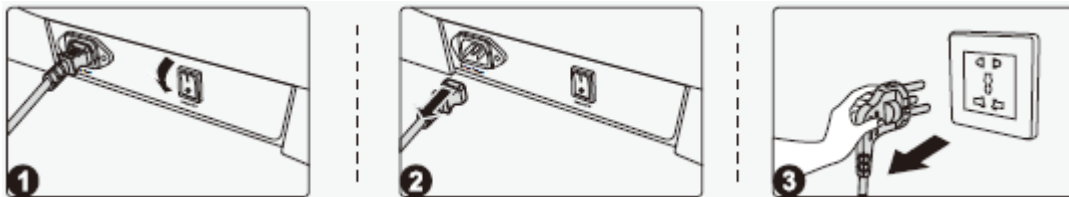

## BLUETOOTH

Find your new device on your phone. The chair will be called IMCM-XXXX (X is the unique number of the chair). Pair the chair with your phone and you can play music from your phone.

## ASSEMBLY

### ASSEMBLY OF ARMRESTS

Locate the connectors and extend from the bottom to the center of the rear frame the end of the chair (Fig. 1).

Then connect the connectors (Fig. 2).

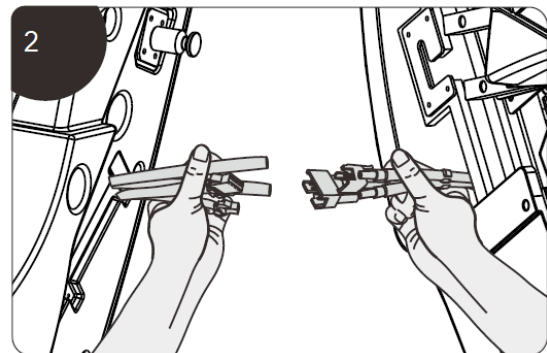
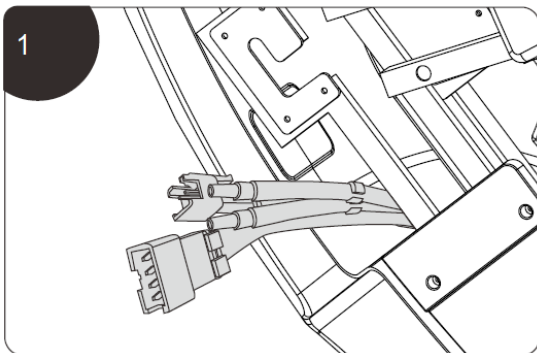

Connect the air hoses (Fig. 3).

After connecting all the parts, carefully insert the cables and air hoses into the chair. Be careful not to pinch any parts (Fig. 4).

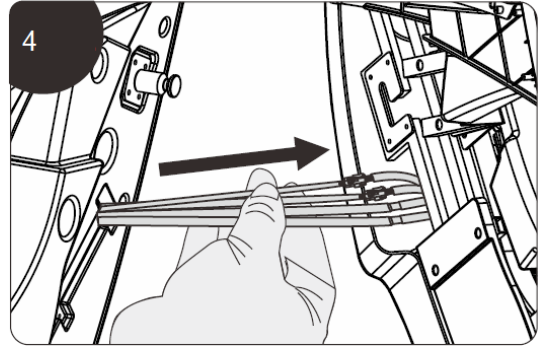
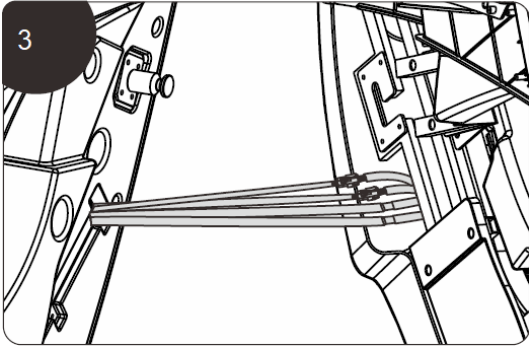

Grasp the armrest on both sides and slide the armrest into the holder (Fig. 5).

Push the armrest into the holder on the front and make sure that it is properly attached (Fig. 6).

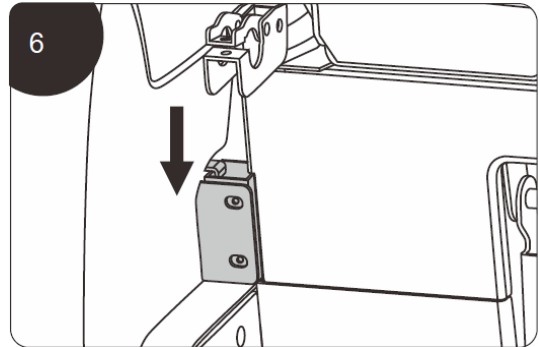
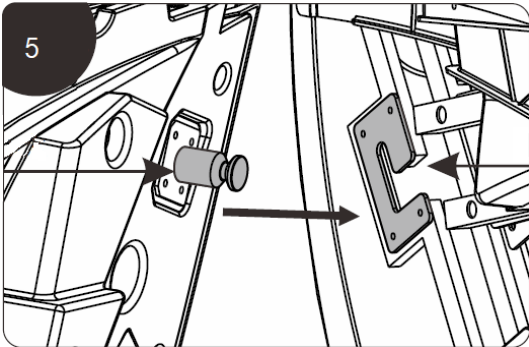

Fasten the front side with 2x screws M5x14 - 12.9 and 2x washers 6 x 12 x 1.5 (Fig. 7).

Fasten the back side with 6x ST4.2 x 12 screws (Fig. 8).

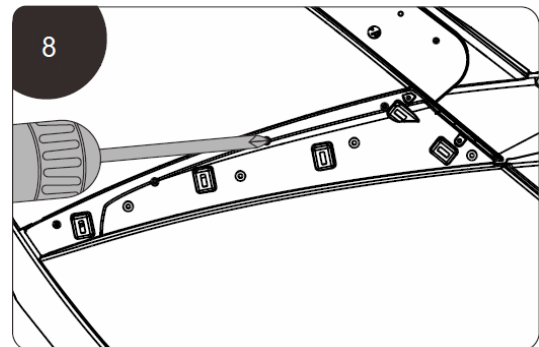
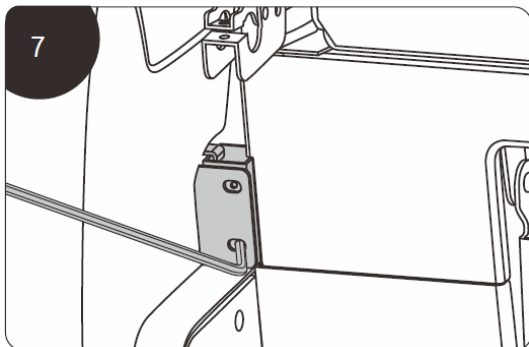

Attach the decorative covers (Fig. 9).

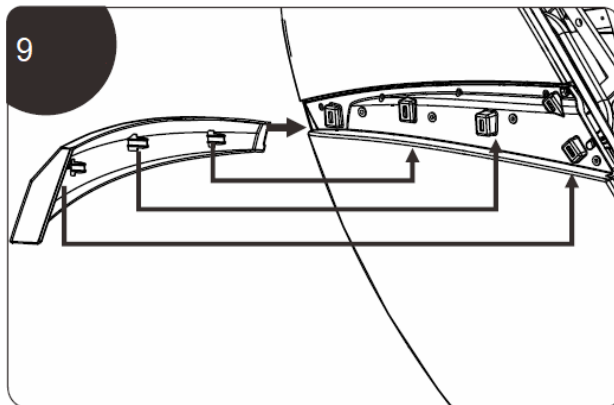

## LEG REST ASSEMBLY

Attach all hoses and connectors (Fig. 1).

Attach the hoses and cables and then insert them into the chair frame. Be careful not to pinch the cables and hoses (Fig. 2).

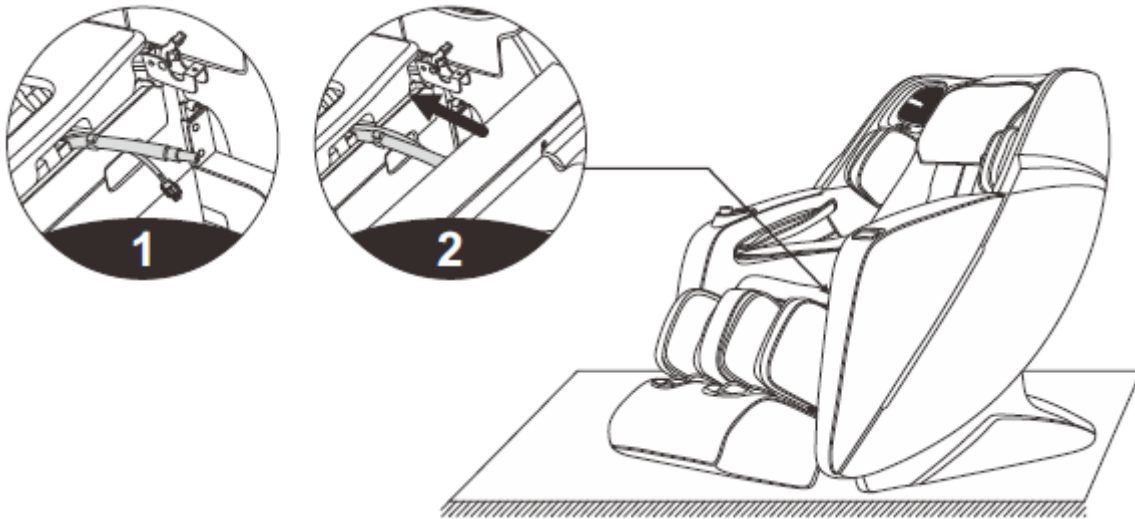

Attach the sleeves to the leg rest (the larger sleeve must be on the outside) (Fig. 3).

Pull out the leg rest holder (Fig. 4).

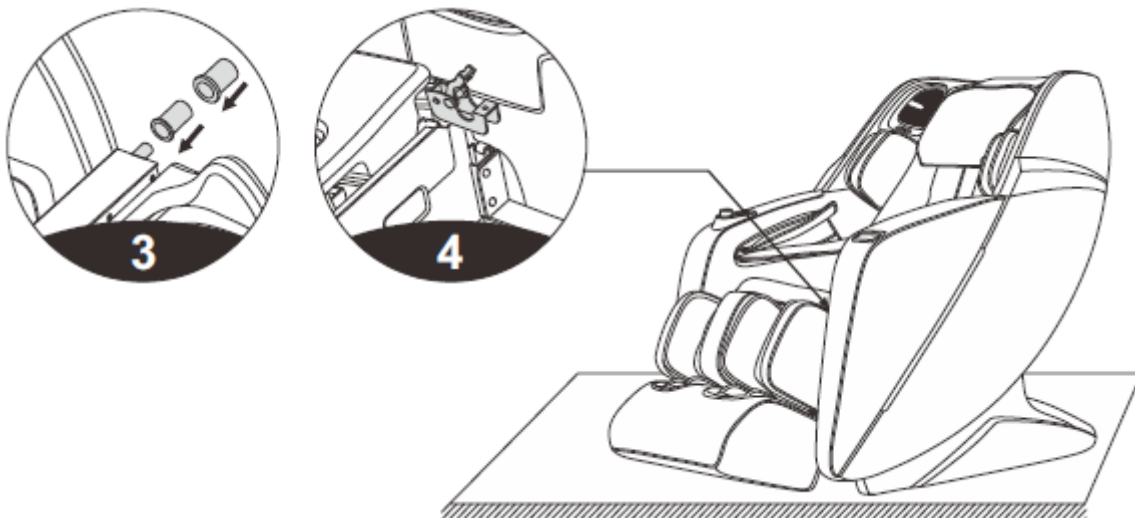

Then attach the leg rest into the holders (5).

Then fasten the covers with 2x screws M5x14 - 12.9 and 2x washers 6x12x1.5 (Fig. 6).

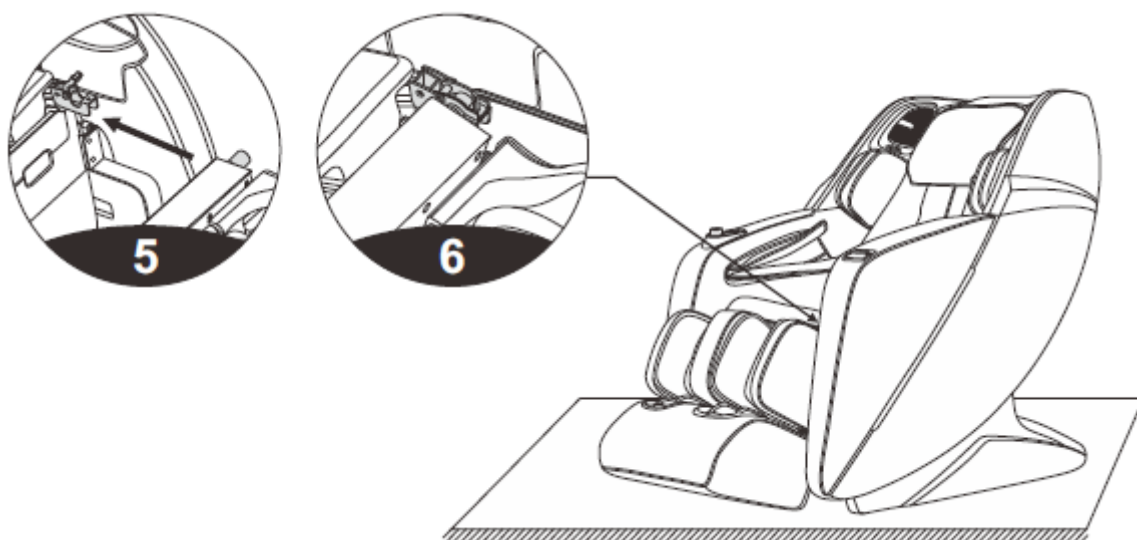

Then attach the cover (Fig. 7).

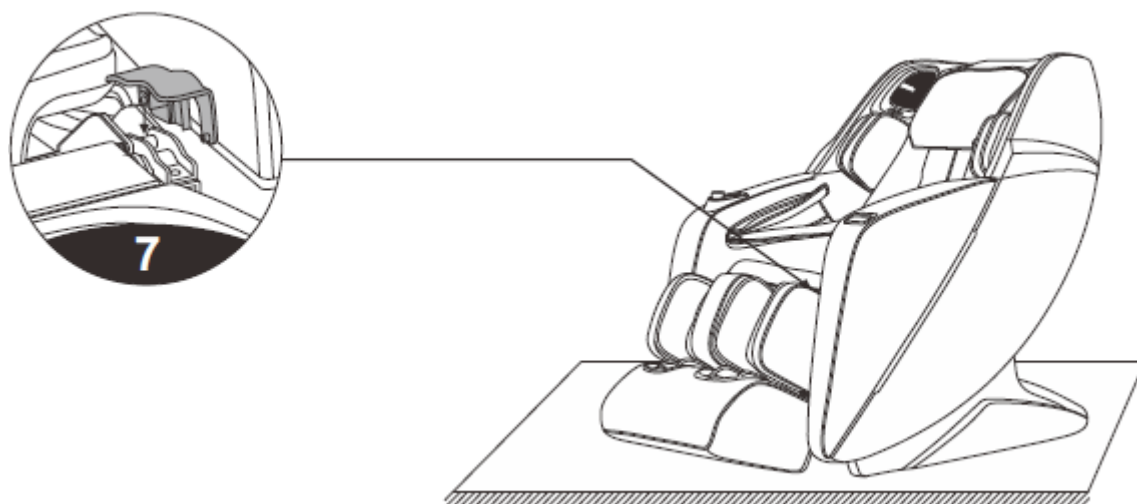

## PILLOWS

The cushions are fastened with a zipper for the backrest (1), the cushions for the headrest with Velcro (2).

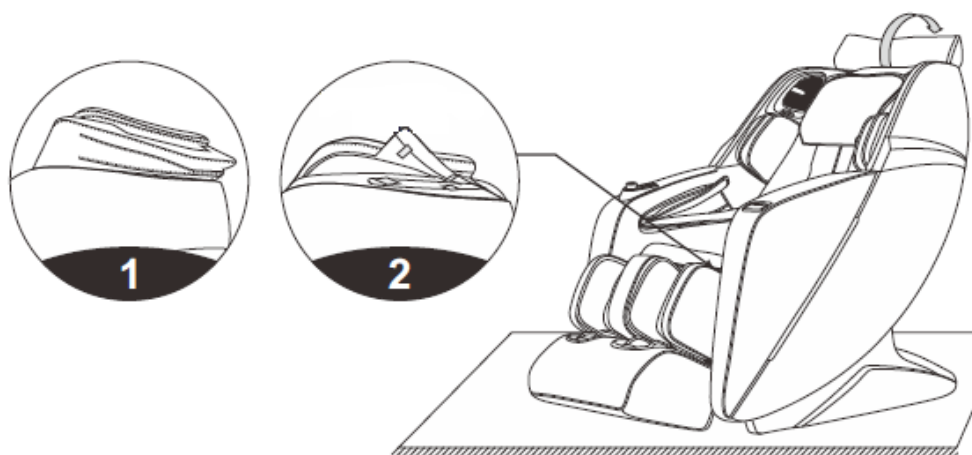

## FLOOR PROTECTION

We recommend using floor protection such as carpets or mats. The weight of the chair could damage the wooden floor.

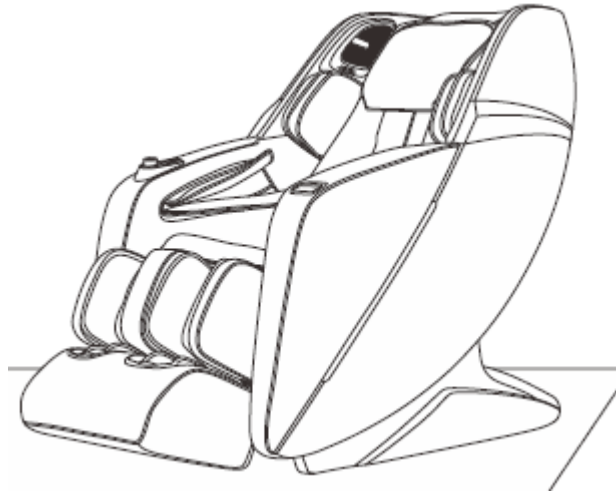

## TRANSPORT

Before moving, make sure that you have switched off the chair and pulled it out of the el. current.

Push on the backrest, the chair will stand on the wheels.

This move is only for a short distance, use auxiliary tools and more people to move for longer distances.

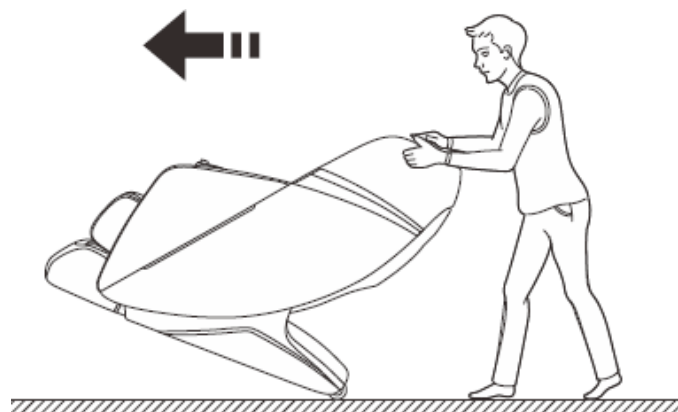

## SPECIFICATIONS

Model:	A600
Configuration:	2
Name:	Massage armchair
Rated voltage:	110-120V 60 Hz 220-240V 50Hz/60Hz
Rated power input	150 W
Operation time	20 min
Safety:	Class I



## ENVIRONMENT PROTECTION

After the product lifespan expired or if the possible repairing is uneconomic, dispose it according to the local laws and environmentally friendly in the nearest scrapyards.

By proper disposal you will protect the environment and natural sources. Moreover, you can help protect human health. If you are not sure in correct disposing, ask local authorities to avoid law violation or sanctions.

Don't put the batteries among house waste but hand them in to the recycling place.

## TERMS AND CONDITIONS OF WARRANTY, WARRANTY CLAIMS

### General Conditions of Warranty and Definition of Terms

All Warranty Conditions stated here under determine Warranty Coverage and Warranty Claim Procedure. Conditions of Warranty and Warranty Claims are governed by Act No. 89/2012 Coll. Civil Code, and Act No. 634/1992 Coll., Consumer Protection, as amended, also in cases that are not specified by these Warranty rules.

The seller is SEVEN SPORT s.r.o. with its registered office in Strakonická street 1151/2c, Prague 150 00, Company Registration Number: 26847264, registered in the Trade Register at Regional Court in Prague, Section C, Insert No. 116888.

According to valid legal regulations it depends whether the Buyer is the End Customer or not.

"The Buyer who is the End Customer" or simply the "End Customer" is the legal entity that does not conclude and execute the Contract in order to run or promote his own trade or business activities.

"The Buyer who is not the End Customer" is a Businessman that buys Goods or uses services for the purpose of using the Goods or services for his own business activities. The Buyer conforms to the General Purchase Agreement and business conditions.

These Conditions of Warranty and Warranty Claims are an integral part of every Purchase Agreement made between the Seller and the Buyer. All Warranty Conditions are valid and binding, unless otherwise specified in the Purchase Agreement, in the Amendment to this Contract or in another written agreement.

### Warranty Conditions

#### Warranty Period

The Seller provides the Buyer a 24 months Warranty for Goods Quality, unless otherwise specified in the Certificate of Warranty, Invoice, Bill of Delivery or other documents related to the Goods. The legal warranty period provided to the Consumer is not affected.

By the Warranty for Goods Quality, the Seller guarantees that the delivered Goods shall be, for a certain period of time, suitable for regular or contracted use, and that the Goods shall maintain its regular or contracted features.

### Batteries

6-month battery warranty – we guarantee that battery's nominal capacity does not fall below 70% of its total capacity within 6 months of the product's sale.

#### The Warranty does not cover defects resulting from (if applicable):

- User's fault, i.e. product damage caused by unqualified repair work, improper assembly, insufficient insertion of seat post into frame, insufficient tightening of pedals and cranks
- Improper maintenance
- Mechanical damages
- Regular use (e.g. wearing out of rubber and plastic parts, moving mechanisms, joints, wear of brake pads/blocks, chain, tires, cassette/multi wheel etc.)
- Unavoidable event, natural disaster

- Adjustments made by unqualified person
- Improper maintenance, improper placement, damages caused by low or high temperature, water, inappropriate pressure, shocks, intentional changes in design or construction etc.

### **Warranty Claim Procedure**

The Buyer is obliged to check the Goods delivered by the Seller immediately after taking the responsibility for the Goods and its damages, i.e. immediately after its delivery. The Buyer must check the Goods so that he discovers all the defects that can be discovered by such check.

When making a Warranty Claim the Buyer is obliged, on request of the Seller, to prove the purchase and validity of the claim by the Invoice or Bill of Delivery that includes the product's serial number, or eventually by the documents without the serial number. If the Buyer does not prove the validity of the Warranty Claim by these documents, the Seller has the right to reject the Warranty Claim.

If the Buyer gives notice of a defect that is not covered by the Warranty (e.g. in the case that the Warranty Conditions were not fulfilled or in the case of reporting the defect by mistake etc.), the Seller is eligible to require a compensation for all the costs arising from the repair. The cost shall be calculated according to the valid price list of services and transport costs.

If the Seller finds out (by testing) that the product is not damaged, the Warranty Claim is not accepted. The Seller reserves the right to claim a compensation for costs arising from the false Warranty Claim.

In case the Buyer makes a claim about the Goods that is legally covered by the Warranty provided by the Seller, the Seller shall fix the reported defects by means of repair or by the exchange of the damaged part or product for a new one. Based on the agreement of the Buyer, the Seller has the right to exchange the defected Goods for a fully compatible Goods of the same or better technical characteristics. The Seller is entitled to choose the form of the Warranty Claim Procedures described in this paragraph.

The Seller shall settle the Warranty Claim within 30 days after the delivery of the defective Goods, unless a longer period has been agreed upon. The day when the repaired or exchanged Goods is handed over to the Buyer is considered to be the day of the Warranty Claim settlement. When the Seller is not able to settle the Warranty Claim within the agreed period due to the specific nature of the Goods defect, he and the Buyer shall make an agreement about an alternative solution. In case such agreement is not made, the Seller is obliged to provide the Buyer with a financial compensation in the form of a refund.

#### **CZ**

##### **SEVEN SPORT s.r.o.**

Registered Office: Strakonická 1151/2c, Praha 5, 150 00, ČR  
 Headquarters: Dělnická 957, Vítkov, 749 01  
 Warranty & Service: Čermenská 486, Vítkov 749 01

CRN: 26847264  
 VAT ID: CZ26847264

Phone: +420 556 300 970  
 E-mail: eshop@insportline.cz  
 reklamace@insportline.cz  
 servis@insportline.cz

Web: www.inSPORTline.cz

#### **SK**

##### **inSPORTline s.r.o.**

Headquarters, warranty & service center: Električná 6471, Trenčín 911 01, SK

CRN: 36311723  
 VAT ID: SK2020177082

Phone: +421(0)326 526 701  
 E-mail: objednavky@insportline.sk  
 reklamacie@insportline.sk  
 servis@insportline.sk

Web: www.inSPORTline.sk