

FINNLO
BIO FORCE



11/06/12 INTL

Item No.:3842

11. Service-Hotline und Ersatzteilbestellformular



Um Ihnen optimal helfen zu können, halten Sie bitte
**Artikel-Nummer, Seriennummer, Explosionszeichnung und
Teileliste** bereit.

S E R V I C E - H O T L I N E

Tel.: 0731-97488- 29, 62 oder -68

Fax: 0731-97488-64

Montag bis Donnerstag
Freitag

von **09.00 Uhr** bis **16.00 Uhr**
von **09.00 Uhr** bis **14.00 Uhr**

E-Mail: service@hammer.de



An
Hammer Sport AG
Abt. Kundendienst
Von-Liebig-Str. 21
89231 Neu-Ulm

Art.-Nr.:3842 BIO FORCE
Serien Nr.:

Ort: Datum:

Ersatzteilbestellung

(Bitte in Druckbuchstaben ausfüllen!)

Kaufdatum:

Gekauft bei Firma:

(Garantieansprüche nur in Verbindung mit einer Kopie des Kaufbeleges!)

Bitte liefern Sie mir folgende Ersatzteile (Bitte leserlich schreiben!):

Position	Bezeichnung	Stückzahl	Bestellgrund

Käufer:

(Name, Vorname)

(Strasse, Hausnr.)

(PLZ, Wohnort)

(Telefon, Fax)

(E-Mail-Adresse)

Lieferadresse: (wenn abweichend von Käuferadresse)

(Firma)

(Ansprechpartner)

(Strasse, Hausnr.)

(PLZ, Wohnort)

(Telefon, Fax)

(E-Mail-Adresse)

Use the chart below to record your progress. Before writing on it, make as many copies as you think you'll need. We suggest you keep these in a notebook. You will find it both informative and motivational to look back at what you've done. This data will help you chart future fitness goals as you continue to improve.

EXERCISE		Date _____	Date _____	Date _____	Date _____
	SETS				
	REPS				
	RESISTANCE				
	SETS				
	REPS				
	RESISTANCE				
	SETS				
	REPS				
	RESISTANCE				
	SETS				
	REPS				
	RESISTANCE				
	SETS				
	REPS				
	RESISTANCE				
	SETS				
	REPS				
	RESISTANCE				
	SETS				
	REPS				
	RESISTANCE				
	SETS				
	REPS				
	RESISTANCE				
	SETS				
	REPS				
	RESISTANCE				
	SETS				
	REPS				
	RESISTANCE				
	SETS				
	REPS				
	RESISTANCE				

Important Safety Information	2
Specifications & Parts.....	3
Equipment Warning/Caution Labels	4-5
Introduction	6
Assembly Instructions.....	7-21
Parts List/Exploded View	22-23
Care and Storage	24
Exercise Guidelines	25-26
Bio Force® Sport System and Workout	27
Getting Started	
Pulley Positions	28
Adjusting the Slide-N-Lock Shifter	29
Adjusting the Seat and Leg Attachment.....	29
8 Week Body Transformation Plan	30-39
Warm-Up & Cool Down Stretches	40-41
Bio Force® Sport Exercises	42-82
Legs	44-54
Chest & Back	55-64
Shoulders	65-71
Arms.....	72-80
Abs & Lower Back.....	81-82
Cardiovascular Conditioning	
Progressive Cardiovascular Training Program	83-85
Cardio Workout Tracking Sheets	86
Progress Chart.....	87
Exercise Log	88

! WARNING

YOU AND OTHERS CAN BE SERIOUSLY INJURED OR KILLED IF WARNINGS ON THE EQUIPMENT, IN THIS OWNER'S MANUAL AND VIDEO ARE NOT FOLLOWED.



- 1) **Before starting this or any other exercise program, consult your physician.** Your physician should assist you in determining the target heart rate zone appropriate for your age and physical condition. Certain exercise programs or types of equipment may not be appropriate for all people. This is especially important for people over the age of 35, pregnant women, or those with pre-existing health problems or balance impairments. **If you are taking medication which may affect your heart rate,** a physician's advice is absolutely essential.
- 2) **Start out slowly and progress sensibly.** Even if you are an experienced exerciser, start with the beginner workout and become familiar with all of the exercises before moving on to more advanced workouts or exercises. For best results, perform all of the exercises at the tempo demonstrated in the video.
- 3) **Do not overexert yourself with this or any other exercise program.** Listen to your body and respond to any reactions you may be having. You must learn to distinguish "good" pain, like fatigue, from "bad" pain, which hurts. **If you experience any pain or tightness in your chest, an irregular heartbeat, dizziness, nausea, or shortness of breath, stop exercising at once and consult your physician immediately.**
- 4) **Warm up** before any exercise program by doing 5 to 10 minutes of aerobic activity, followed by stretching.
- 5) **Before EACH use, visually inspect the equipment. Never operate the equipment if the equipment is not functioning properly.**
- 6) **USE CARE when getting on and off the equipment.** Set up and use your equipment on a solid, level, surface. Follow the instructions demonstrated in your video and as instructed with the exercises on pages 44 through 82 for proper exercise techniques.
- 7) **Use this equipment ONLY for the intended use** as described in this manual. **Do not** modify the equipment or use attachments not recommended by the manufacturer.
- 8) **Have plenty of clearance space on all sides of your equipment.** It is important to keep children, pets, furniture and other objects out of the way when using your equipment.

- 9) **Wear appropriate clothing when exercising.** Workout clothing should be comfortable and lightweight, and should allow freedom of movement. Wear comfortable athletic shoes made of good support with non-slip soles, such as running or aerobic shoes.
- 10) **THIS EQUIPMENT IS NOT FOR USE BY CHILDREN. Parents and others in charge of children should be aware of their responsibility because the natural play instinct and the fondness of experimenting of children can lead to situations and behavior for which the training equipment is not intended. To prevent injuries, keep this and all fitness equipment out of the reach of children. Follow these simple rules:**
 - Keep children out of rooms where you have your exercise equipment.
 - Store exercise equipment in a room that can be locked.
 - Know exactly where your children are when you work out.
 - If you have small children at home, don't wear headphones while you work out.
 - Talk to your kids about the dangers of exercise equipment.
- 11) **Breathe naturally,** never holding your breath during an exercise. Avoid over training. You should be able to carry on a conversation while exercising.
- 12) **Cool down after an exercise session,** with 5 to 10 minutes of slow walking, followed by stretching.
- 13) **Handicapped or disabled people must have medical approval** before using this equipment and should be under close supervision when using any exercise equipment.
- 14) **Only one person at a time should use this equipment.**
- 15) **DO NOT put hands, feet, or any foreign objects on or near this equipment when in use by others.** Use caution not to pinch fingers or hands in moving parts when setting up or using the equipment.

Every two weeks, measure yourself and use the chart below to record your progress. Before writing on it, make as many copies as you think you'll need. We suggest you keep these in a notebook. You will find it both informative and motivational to look back at what you've done. This data will help you chart future fitness goals as you continue to improve.

Measuring Sites

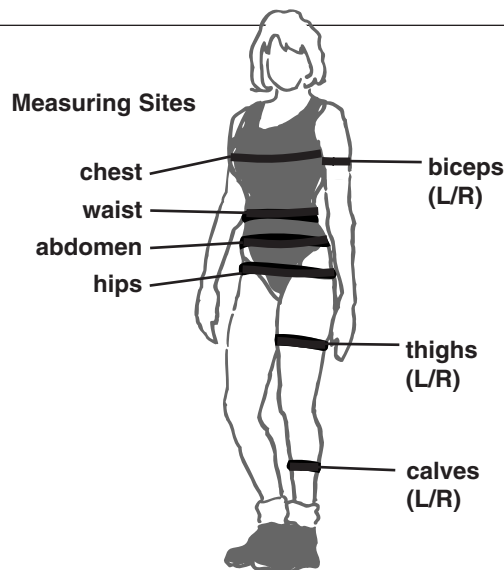

Date	Weight	Chest	Biceps	Waist	Abdomen	Hips	Thighs	Calves

Use these charts to keep track of your progress over time. Before writing on them, make as many copies as you think you'll need. We suggest you keep these in a notebook. You will find it both informative and motivational to look back at what you've done.

This data will help you chart future fitness goals as you continue to improve.

ACTIVITY	DATE	HOW LONG (minutes)	HEART RATE	HOW HARD (RPE)*

ACTIVITY	DATE	HOW LONG (minutes)	HEART RATE	HOW HARD (RPE)*

*RPE = rating of perceived exertion; this means you match up a numerical rating (RPE) of 1-10, with how you feel (RPE descriptive rating in chart above). A rating of 2-3 is equal to a warm-up or recovery level of effort; 4-5 equates to moderate to somewhat challenging; 6-10 represents effort that is somewhat hard, to very hard.

Assembled Approximate Specifications:
Dimensions are based on unit set up for use.

Length: 52-3/4"
Width: 65"
Height: 82"

Product Weight: Approx. 151 lbs.
Maximum user weight: 300 lbs.

Includes Workout DVD

NOTE:
All location references, such as front, rear, left or right, made in these instructions are from the user sitting on the exerciser and facing forward.

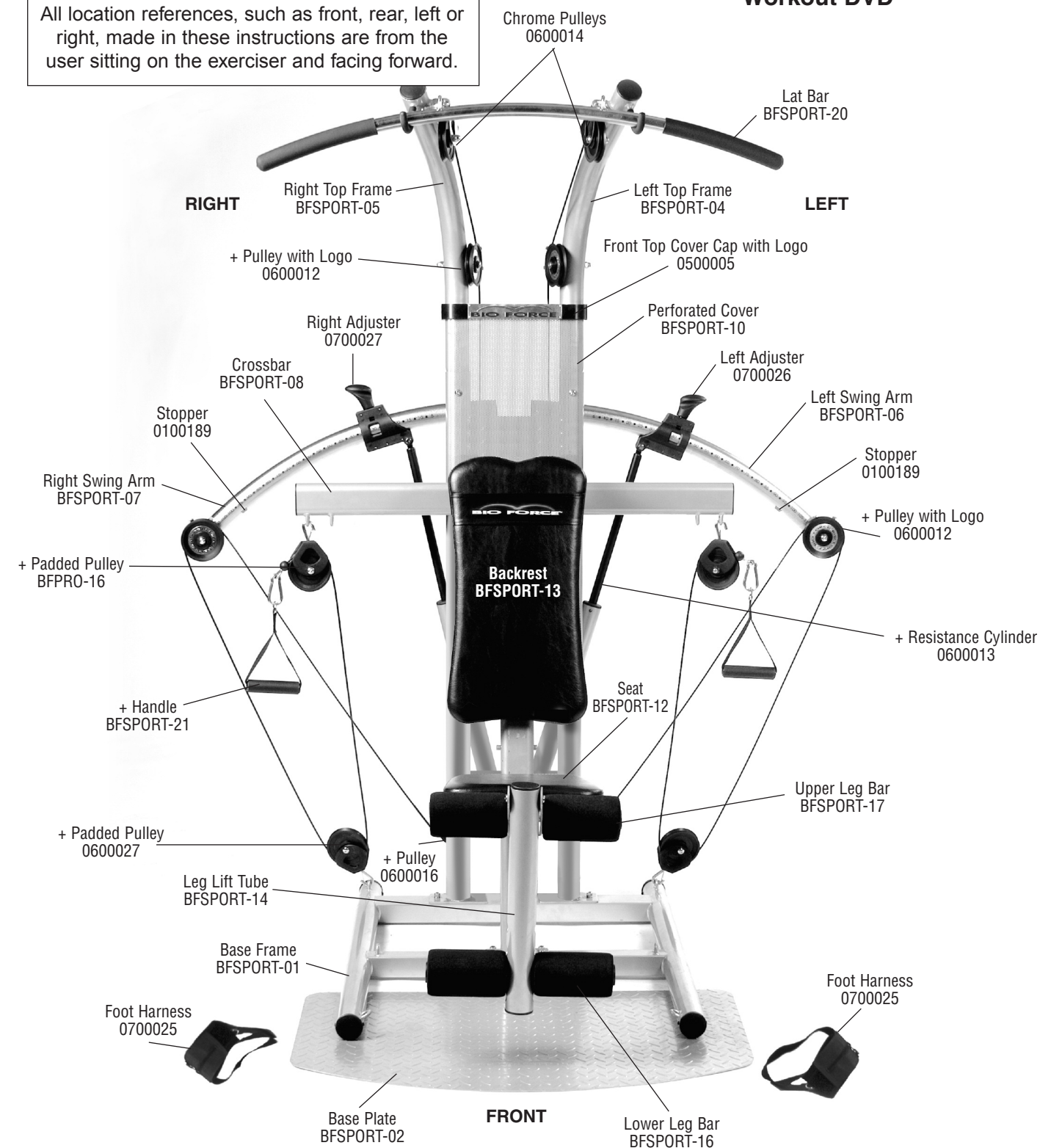

+ These parts are the same on both the left and right side of the exerciser.

IMPORTANT:
Note placement
of the following
Warning/Caution
Labels on your
equipment.

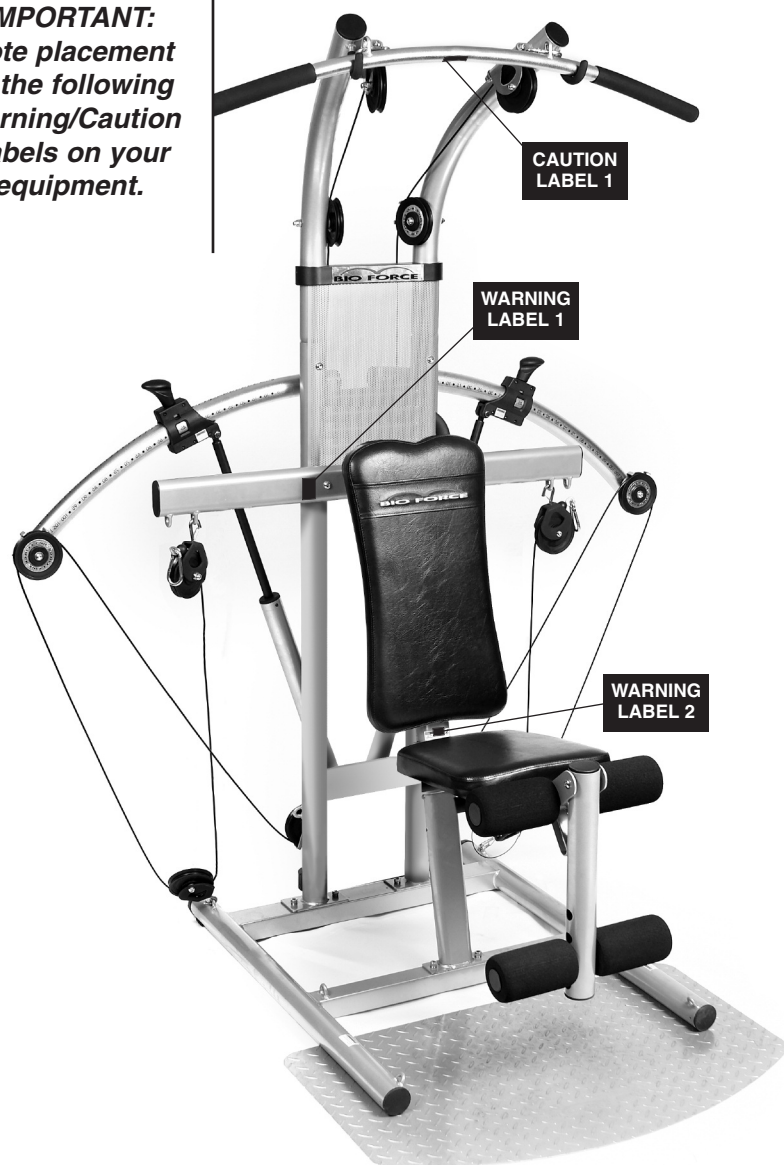

CAUTION LABEL 1

⚠ CAUTION
Always keep the Lat Bar in its holder when not in use.

WARNING LABEL 1

⚠ WARNING
Failure to read and follow the safety instructions stated in the Owner's Manual and Video may result in POSSIBLE SERIOUS INJURY OR DEATH. KEEP CHILDREN AWAY. Maximum user weight 300 lbs. Replace this label if damaged, illegible or removed. Class HC.

WARNING LABEL 2

⚠ WARNING
 CRUSH HAZARD. Keep hands clear while assembling and disassembling.

WARNING LABEL 3

⚠ WARNING

CRUSH HAZARD. Keep hands clear while operating.

WARNING LABEL 5

⚠ WARNING

Keep hands away from pulleys and moving parts.



The training program that follows is a progressive training program for cardiovascular conditioning. It can be used for any aerobic activity you choose. But remember, these are only guidelines. People with medical conditions should discuss this training program with their physician.

CONDITIONING BASE

WEEK	HOW OFTEN (times per week)	HOW LONG (minutes)	HOW HARD (% heart rate)	HOW HARD (RPE)*	RPE DESCRIPTIVE RATING
1	2 - 3	5 - 15	40 - 50	2 - 4	Somewhat easy to somewhat hard
2	2 - 3	5 - 15	40 - 50	2 - 4	Somewhat easy to somewhat hard
3	2 - 3	10 - 17	40 - 50	2 - 4	Somewhat easy to somewhat hard
4	2 - 3	10 - 17	50 - 60	2 - 4	Somewhat easy to somewhat hard
5	3	15 - 20	50 - 60	2 - 4	Somewhat easy to somewhat hard
6	3 - 4	15 - 20	50 - 60	2 - 4	Somewhat easy to somewhat hard

MOVING BEYOND BASE-LEVEL FITNESS

WEEK	HOW OFTEN (times per week)	HOW LONG (minutes)	HOW HARD (% heart rate)	HOW HARD (RPE)*	RPE DESCRIPTIVE RATING
7 - 9	3 - 4	20 - 25	60 - 65	3 - 4	Moderate to somewhat hard
10 - 13	3 - 4	21 - 25	65 - 70	4 - 5	Somewhat hard to hard
14 - 16	3 - 4	26 - 30	65 - 70	4 - 5	Somewhat hard to hard
17 - 19	3 - 5	26 - 30	70 - 75	4 - 5	Somewhat hard to hard
20 - 23	3 - 5	31 - 35	70 - 75	4 - 5	Somewhat hard to hard
24 - 27	3 - 6	31 - 35	70 - 75	4 - 5	Somewhat hard to hard

MAINTENANCE

WEEK	HOW OFTEN (times per week)	HOW LONG (minutes)	HOW HARD (% heart rate)	HOW HARD (RPE)*	RPE DESCRIPTIVE RATING
After 4-6 months	3 - 6	30 - 60	40 - 85	3 - 6	Easy - Moderate to somewhat hard

*RPE = rating of perceived exertion; this means you match up a numerical rating (RPE) of 1-10, with how you feel (RPE descriptive rating in chart above). A rating of 2-3 is equal to a warm-up or recovery level of effort; 4 - 5 equates to moderate to somewhat challenging; 6 -10 represents effort that is somewhat hard, to very hard.

Smart Progression

In regard to progressing to a higher intensity level, longer duration, or more frequent sessions, it makes good sense to change only one of these elements at a time. You run a higher risk of overuse injury if you simultaneously increase more than one of these elements. A conservative yet effective guideline is to increase intensity or duration by no more than about 5 percent. You should adapt to this increase over a period of a week or two, and then consider changing one of the other variables (frequency, duration or intensity) or further progressing the one you've adapted to.

Top Aerobic Exercise

No one cardiovascular activity is better than another! Manipulating how hard (intensity), how often (duration), and how long (frequency) you participate in a particular aerobic activity determines its effectiveness or lack thereof. And of course, you have to like what you're doing. Choose the type of aerobic activity that is right for you by identifying one or more types of cardio exercise that you can see yourself sticking to, and enjoying, for the rest of your life. Often, the best aerobic exercise will be not one, but several activities that are fun and feel good to your body. Excellent cardiovascular activities include, but are not limited to, walking, swimming, water fitness, jogging, running, cross-country skiing, in-line skating, lateral movement training (slide), cycling, mountain biking, and step training.

How Often, How Long, and How Hard

The choices you make about the frequency (how often), duration (how long), and intensity (how hard) at which you will train, will directly influence your training results.

How often. If you want to see serious improvements in your fitness, lose weight and develop a good training base, you need to do cardio workouts three to six times per week.

If you are just starting a program or out of shape, don't let these recommendations discourage or mislead you. Realize that doing cardio training two to three times per week will still result in significant fitness improvement and health benefits. Your long-term goal is to build up to exercising your heart on most days of the week.

How long. How long you work out depends on your current level of fitness. Again, if you're just starting a program or out of shape, don't follow strict textbook recommendations. Instead, start with 5 to 10 minutes once or twice per day. You will see significant fitness improvement. Your long-term goal is to build to a duration of 30 to 60 minutes of cardiovascular activity on most days of the week.

How hard. Aerobic intensity guidelines for healthy adults are generally set at 60 to 85 percent of heart rate. But, if you're out of shape, remember that moderate to low level and consistent cardiovascular training – well below the standard recommendations set forth – can result in substantial and beneficial effects to your health and can greatly improve cardiovascular endurance.

You can use the following calculation to determine what percentage of your heart rate you are working at:

$$\% \text{ heart rate} = (220 - \text{age}) \times \%$$

Using this calculation, a 70% heart rate for a 40 year old would be $(220 - 40) \times 70\%$ or 126. Thus, this individual would need to reach 126 beats per minute to equal a 70% heart rate.

The above are guidelines, people with any medical limitations should discuss this formula with their physician.

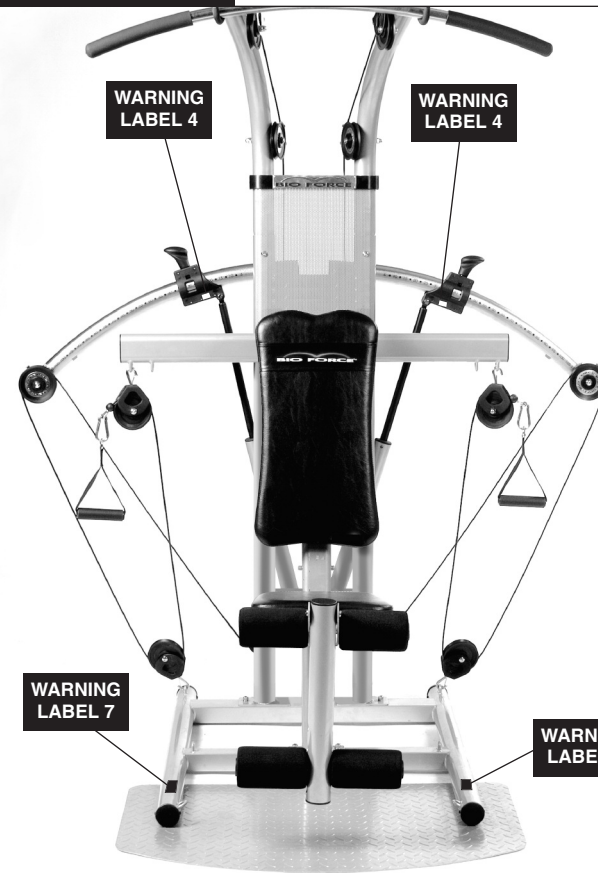

WARNING LABEL 4 (2 locations)

WARNING
Make sure that pin is locked in place before beginning to exercise.

WARNING LABEL 7 (2 locations)

WARNING
When performing standing exercises, place feet firmly on floor plate.

WARNING LABEL 5 (6 locations)

WARNING
Keep hands away from pulleys and moving parts.

WARNING LABEL 6 (2 locations)

WARNING
CRUSH HAZARD. Keep hands clear when moving Adjuster Arms.

WARNING LABEL 8 (2 locations)

WARNING
Contents under pressure. DO NOT OPEN. Keep away from heat and fire.

WARNING LABEL 9 (2 locations)

WARNING
DO NOT REMOVE PULLEY from this position after unit is assembled.

CAUTION LABEL 2

CAUTION
When transporting for storage we recommend two people move this unit.

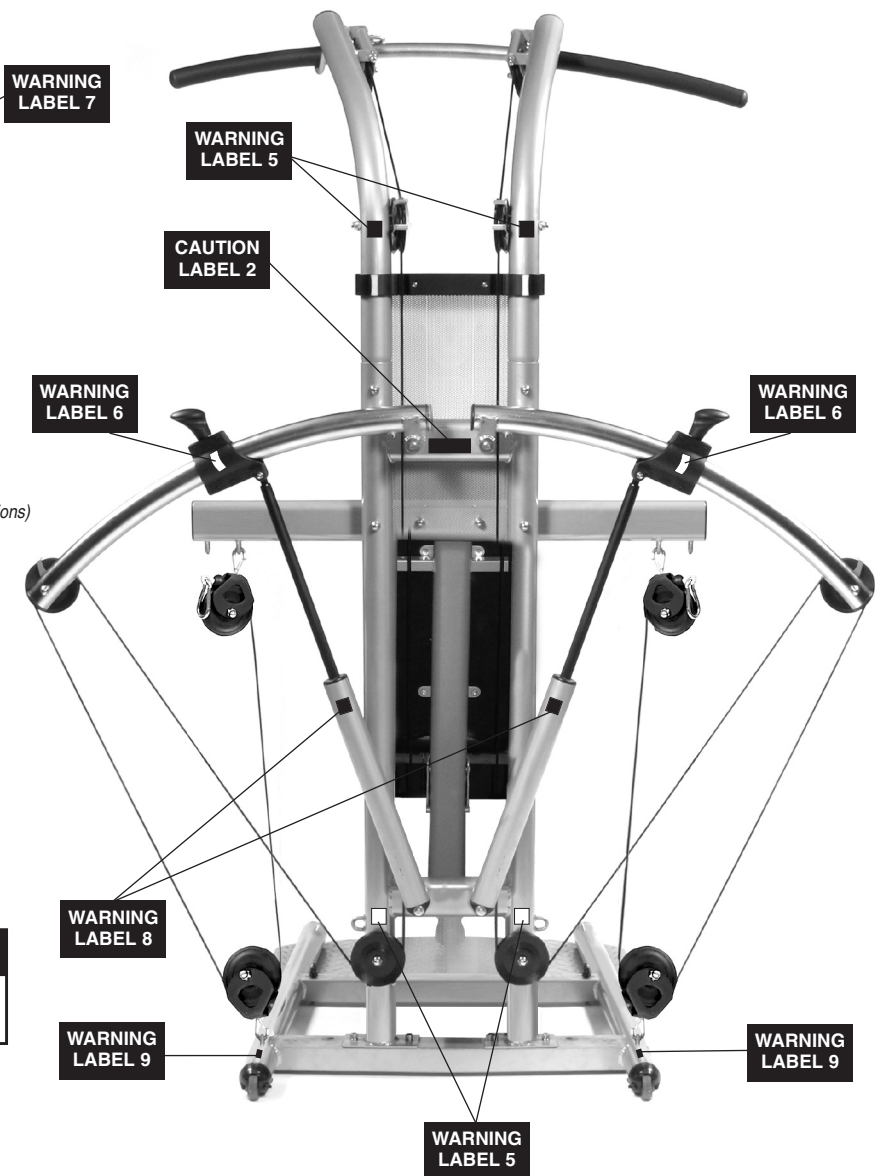

WARNING LABEL 5

CAUTION LABEL 2

WARNING LABEL 6

WARNING LABEL 6

WARNING LABEL 8

WARNING LABEL 9

WARNING LABEL 9

WARNING LABEL 5

Congratulations!

Congratulations on your purchase of the Bio Force® Sport System! You've just taken an important step toward your lifelong fitness goals. Whether that means building a strong defined chest, lean sexy legs or total body sculpting, the Bio Force® Sport System can help you get the results you desire.

The Bio Force® Sport exerciser is a solid piece of equipment that uses nitrogen-charged cylinders to give you resistance through an exercise's entire range of motion. With over one hundred body shaping exercises, you have everything you need to start your own total body workout program. The Bio Force® Sport exerciser allows you to tone and firm the major muscle groups of your upper and lower body. This is vital for everyone – regardless of age, sex, or fitness level.

To help you get started, we have included this thorough Owner's Manual. It includes Eric Lichter's "8 Week Body Transformation Plan," descriptions of all of the Bio Force® exercises and an aerobic workout guide. You also have Eric's Instructional Video which features tips on proper form and technique and a Healthy Eating Plan Booklet. These tools will give you a core group of exercises, and workout and nutrition plans to help you get results.

Be sure to read through this Owner's Manual carefully.

If, during the course of using your system, you have any questions about the program, please contact your local distributor. As always, you have our personal assurance that we want your complete satisfaction. After all, your success is our success too!

IMPORTANT: This owner's manual is the authoritative source of information about your Bio Force® Sport exerciser. Please read it carefully and follow all the instructions.

Exercise that challenges the heart is a simple part of an exercise program – almost anyone can walk, run, treadmill, climb steps, or bike. But, creating a progressive, time efficient and results oriented cardio program takes a little planning. A properly designed and consistently performed cardiovascular training program is an essential part of your program if you want to improve your health and lose weight, or maintain a healthy lifestyle.

Training Aerobically

Aerobic exercise is the key to building a stronger heart and can reduce your chances of heart disease, as well as burn lots of fat and calories. Aerobic exercise is any activity that you can keep at for several minutes or longer and increases your heart rate. Activities that have the potential to condition the heart typically involve the large muscles of the hips, thighs, and buttocks. Examples include walking, hiking, jogging, running, cycling, in-line skating, swimming, cross-country skiing, and stair stepping.

Benefits of Aerobic Training

Health benefits of aerobic exercise include the following:

1. A stronger and healthier heart.
2. Increased HDL. This "good" cholesterol helps keep your arteries unplugged and healthy.
3. Decreased total cholesterol. This is the debris in your blood that can clog your arteries.
4. Reduced blood pressure. Even moderate exercise can help.
5. Reduced risk for heart attack and stroke.
6. Decreased body fat and an ability to help you reach your desirable weight. You'll become a better fat-burner and burn a lot of calories every session.
7. Decreased risk for diabetes.
8. Reduced feelings of anxiety, tension, and depression.
9. Improved sleep.
10. Higher levels of energy. Efficient delivery and use of blood and oxygen is the key to increased vigor and performance.

Warming Up And Cooling Down

Warming up and cooling down are essential to a balanced and safe exercise program. A proper warm-up and cool down can:

- Make your workouts safe and easier to do,
- Limit the risk of unnecessary stress on your heart,
- Get you ready for your activity,
- Improve your stamina and endurance (you won't tire as quickly),
- Decrease your risk for injury,
- Increase enjoyment of your workouts, and
- Help you stick with your health and fitness program.

Warm-Up

To prevent injury and maximize performance, we recommend that each workout period should start with a warm-up. Your warm-up should gently prepare your muscles for the coming exertion. Start by doing 5 to 10 minutes of gentle exercise that gradually increases your heart rate and loosens up your muscles. Your warm-up exercise should be aerobic in nature and only require an easy, unforged range of motion. This should be followed by 5 to 10 minutes of stretching. Refer to the stretches found on pages 40 and 41 of this manual. Never push yourself beyond a point of gentle tension or strain. Keep your movements gentle, rhythmic and controlled.

Cool Down and Stretching

Your workout should be followed by a cool down. The cool down should consist of 5 to 10 minutes of slow walking followed by stretching. Refer to the stretches found on pages 40 and 41 of this manual. Never push yourself beyond a point of gentle tension or strain. Keep your movements gentle, rhythmic and controlled.



109 SIDE BEND

START: Stand facing side. Feet hip width apart on base. Grip one handle with inside hand.

MOTION: Flex trunk laterally, away from handle. Pause at end of motion. Return to starting position.

TIPS: Keep arm straight. Laterally flex trunk, rather than pulling with arm. Contract abdominals to stabilize spine. Perform on both sides.

SEAT: Off
LEG LIFT: Off
ACCESSORIES: Handles

MOVABLE PULLEY POSITIONS

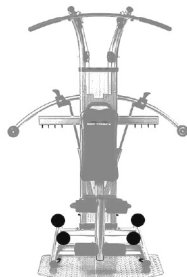

MUSCLE GROUPS EXERCISED: Abdominals, obliques, lateral flexors

LEVEL OF DIFFICULTY: Intermediate

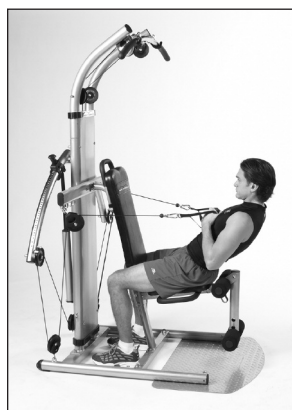
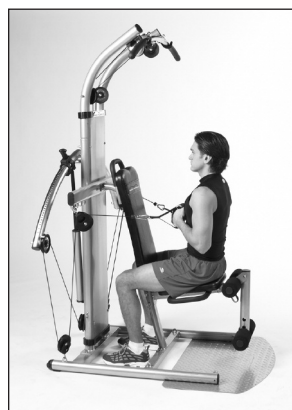

110 SEATED SPINAL EXTENSION

START: Sit facing frame. Grip handles in front of chest. Pull elbows to waist.

MOTION: Extend spine. Pause at end of motion. Return to starting position.

TIPS: Lift ribcage and lengthen spine while extending. Do not over extend spine. Keep elbows in close to body. Avoid pulling with arms. Contract abdominals to stabilize lower back.

SEAT: On/Bottom Position

LEG LIFT: On

ACCESSORIES: Handles

MOVABLE PULLEY POSITIONS

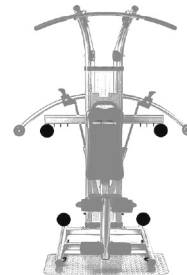

MUSCLE GROUPS EXERCISED: Spinal extensors

LEVEL OF DIFFICULTY: Intermediate

NOTE:
 All location references, such as front, rear, left or right, made in these instructions are from the user sitting on the exerciser and facing forward.

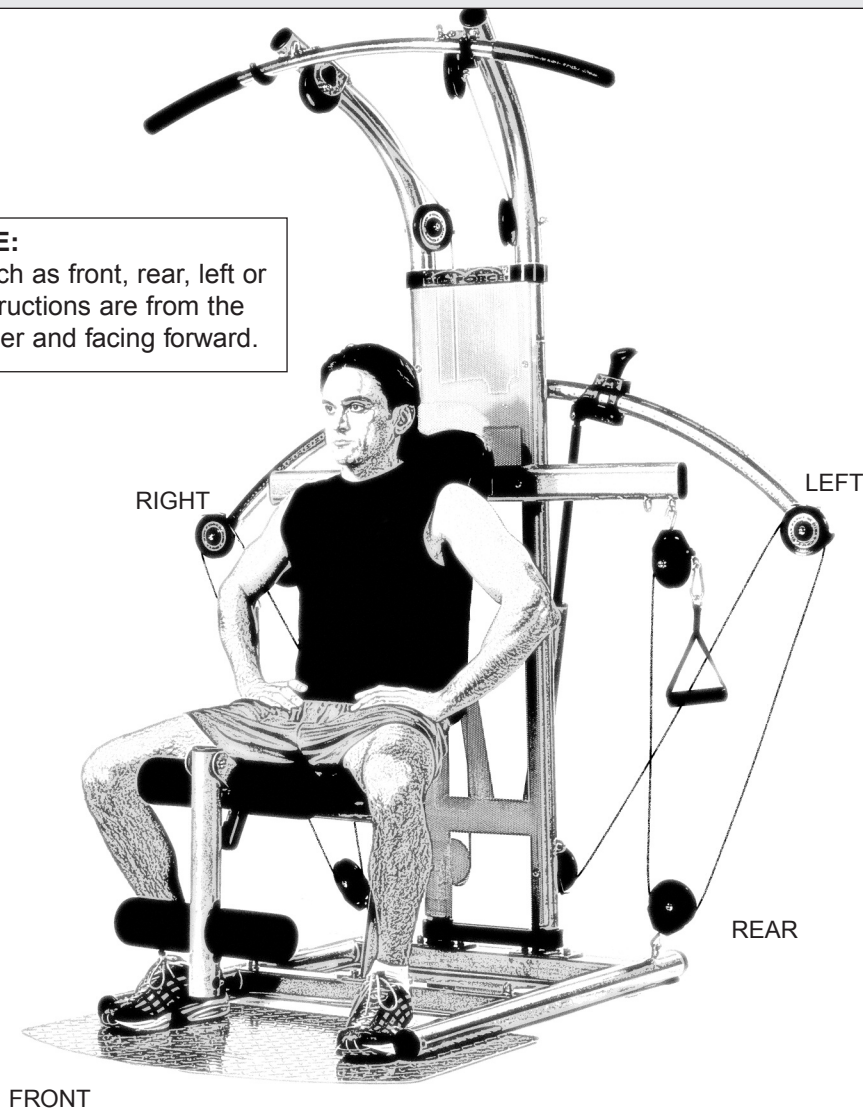

TIPS

Occasionally our products contain components that are pre-lubricated at the factory. We recommend that you protect flooring, or anything else the parts may contact, with newspaper or cloth.

Make sure you have read the manual completely and locate all the parts and tools shown on page 8.

Product will need approx. 83" when tilting for transportation. Make sure you have proper clearance before assembling. We recommend you assemble your equipment in the area you will be using it!

CAUTION! When transporting for storage we recommend two people move the unit.

All nuts and bolts are installed front-to-rear – leaving the nut on the rear.

Some assemblies may require lifting by 2 people.

Lay Out the Parts

Lay out the parts of your Bio Force® Sport exerciser as shown here and on the following pages and familiarize yourself with part names for easier assembly.

Make sure you have all parts.

- Tools provided in Fastener Pack:
- Hex Wrench
 - 5mm Allen Wrench w/Phillips Screwdriver
 - 6mm Allen Wrench
 - 8mm Allen Wrench

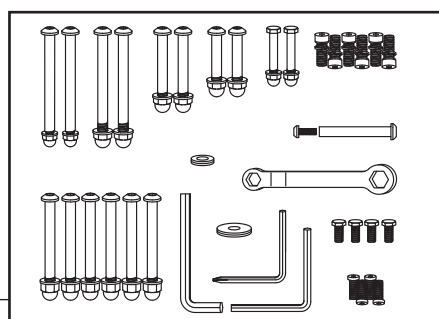

BFSPORT-22 Fastener Pack

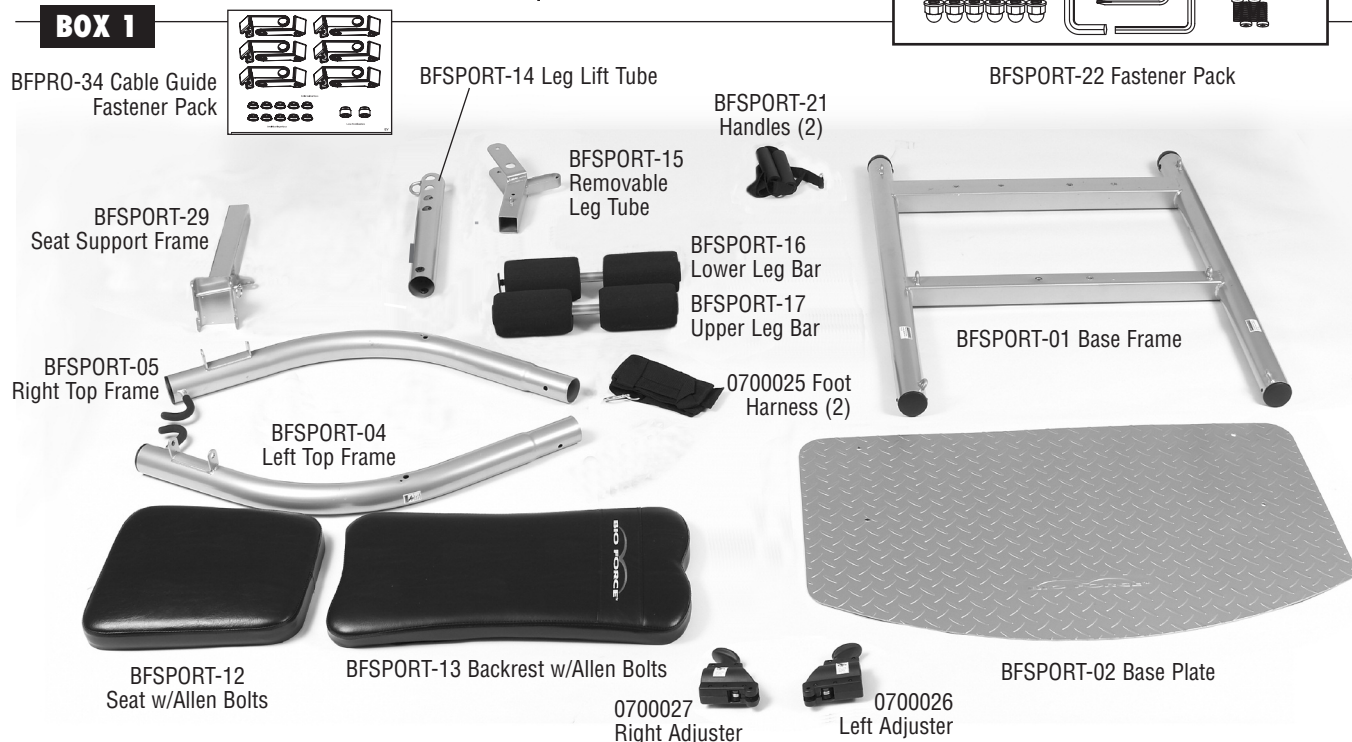

BOX 2

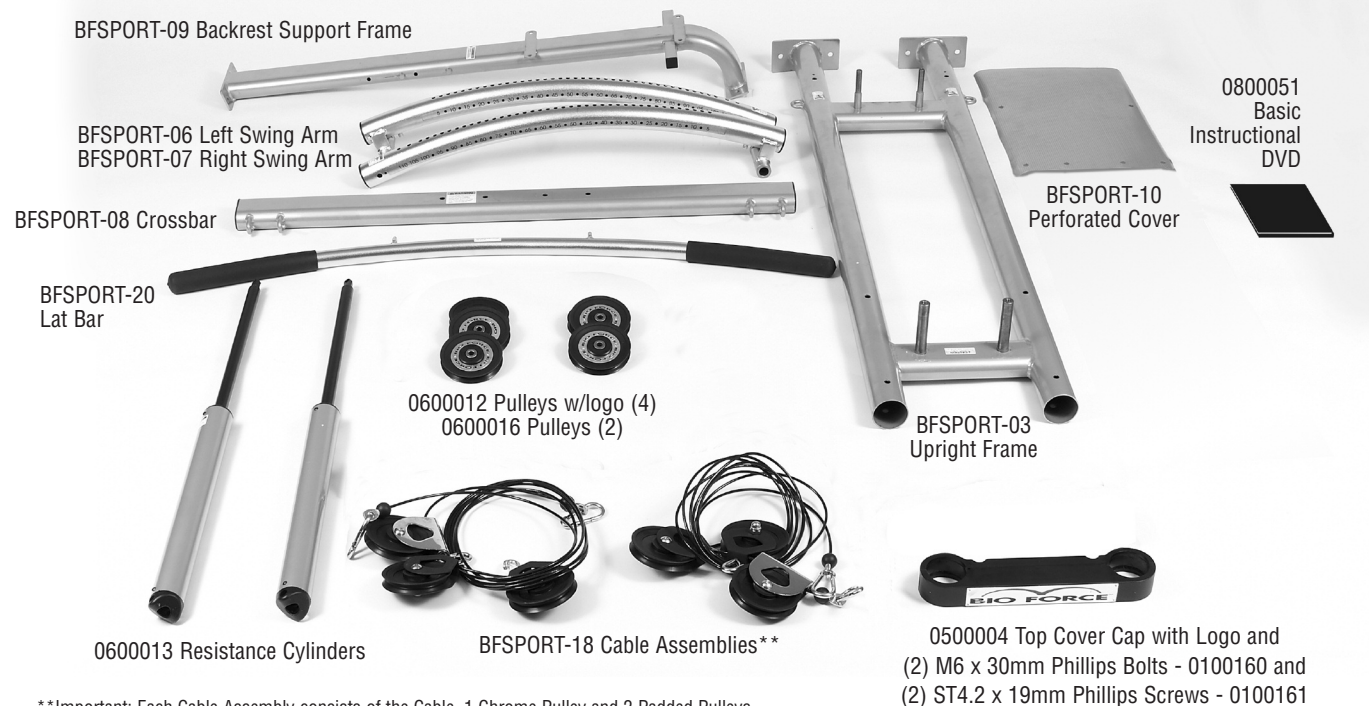

**Important: Each Cable Assembly consists of the Cable, 1 Chrome Pulley and 2 Padded Pulleys



MUSCLE GROUPS EXERCISED: Abdominals

LEVEL OF DIFFICULTY: Beginner



MUSCLE GROUPS EXERCISED: Abdominals, obliques

LEVEL OF DIFFICULTY: Intermediate



MUSCLE GROUPS EXERCISED: Abdominals, obliques

LEVEL OF DIFFICULTY: Intermediate

106 AB CRUNCH

START: Sit facing away. Grip handles at shoulder level. Elbows point front.

MOTION: Curl spine, pulling bottom of ribcage down toward hips. Pause at end of motion. Return to starting position.

TIPS: Do not pull down with arms. Focus work in abdominal muscles. Extend torso to upright seated position after each repetition. Keep neck in line with spine.

SEAT: On/Bottom Position

LEG LIFT: On

ACCESSORIES: Handles/Lat Tower

MOVABLE PULLEY POSITIONS

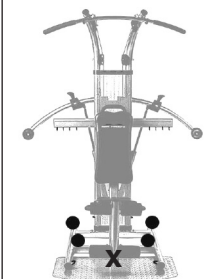

107 OBLIQUE CRUNCH

START: Sit facing away. Grip handles at shoulder level. Elbows point front.

MOTION: Curl spine and simultaneously rotate torso toward one knee. Pause at end of motion. Return to starting position.

TIPS: Do not pull down with arms. Focus work in abdominal muscles. Extend torso to upright seated position after each repetition. Keep neck in line with spine. Perform on both sides.

SEAT: On/Bottom Position

LEG LIFT: On

ACCESSORIES: Handles/Lat Tower

MOVABLE PULLEY POSITIONS

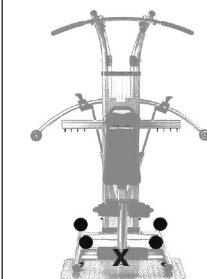

108 STANDING TRUNK ROTATION

START: Stand facing side. Feet hip width apart on base. Rotate torso inward. Grip one handle with both hands.

MOTION: Rotate trunk outward. Pause at end of motion. Rotate inward to starting position.

TIPS: Keep arms straight in front of torso. Rotate trunk rather than pulling with arms. Maintain upright posture throughout exercise. Do not round lower back while rotating. Perform on both sides.

SEAT: Off

LEG LIFT: Off

ACCESSORIES: Handles

MOVABLE PULLEY POSITIONS

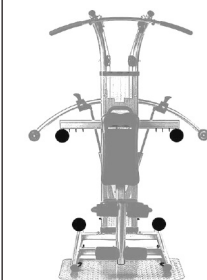



105 CROSS-BODY TRICEPS EXTENSION

START: Sit facing away. Bend one elbow and reach across body to grip handle at opposite shoulder.

MOTION: Extend elbow and press handle in front of body. Pause at end of motion. Bend elbow back to starting position.

TIPS: Keep elbow at shoulder height. Do not bend wrist while extending elbow. Maintain upright posture in seated position. Contract abdominals to stabilize torso. Perform on both sides.

SEAT: On/Top Position

LEG LIFT: On

ACCESSORIES: Handles

MOVABLE PULLEY POSITIONS

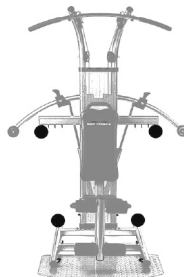

MUSCLE GROUPS EXERCISED: Triceps

LEVEL OF DIFFICULTY: Intermediate

WE SUGGEST YOU ASSEMBLE THE BIO FORCE® SPORT EXERCISER WHERE YOU ARE GOING TO BE USING IT.

Parts used in STEP 1

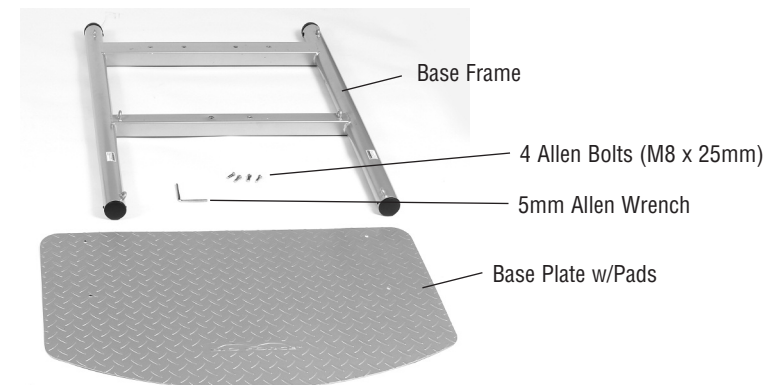

STEP 1 – Base Frame Assembly

- a. Turn the Base Frame over, with the warning labels facing down.
- b. Place the Base Plate on the Base Frame on the end opposite the rollers. Make sure the curved edge of the Base Plate is facing out with the pads up.
- c. Align the holes in the Base Plate and Base Frame and secure the parts by using 4 Allen Bolts. Tighten them with the Allen Wrench provided.

Turn the Base Assembly right side up on the floor (warning labels face up).

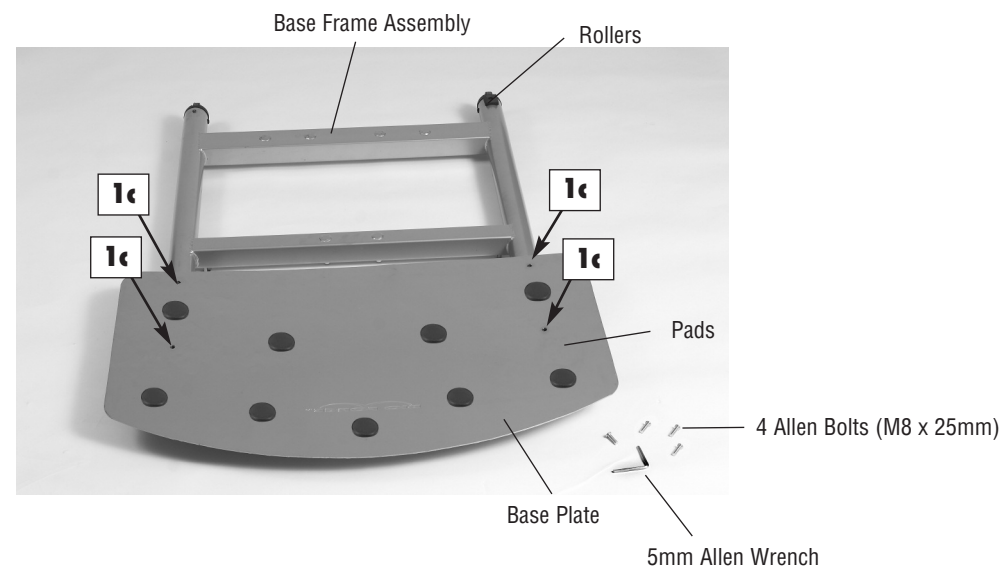

Parts used in STEP 2

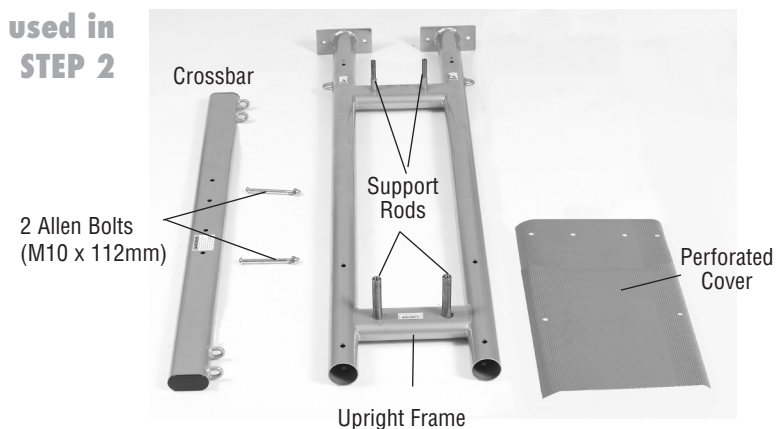

STEP 2 – Upright Frame Assembly

- a. Flip the Upright Frame over so it is resting on the Support Rods, and the warning labels facing down.
- b. Lay the Perforated Cover and Crossbar in place on top of the Frame and align the holes. You should be able to see the warning label on the crossbar.
- c. Insert 2 Allen Bolts down through the outside holes in the Crossbar, Perforated Cover and the Upright Frame. Add Acorn Nuts on the Bolts and hand tighten.

Note: Hand tighten bolts allowing for easier alignment of the frames sections and Pulley Assembly. They will be secured later.

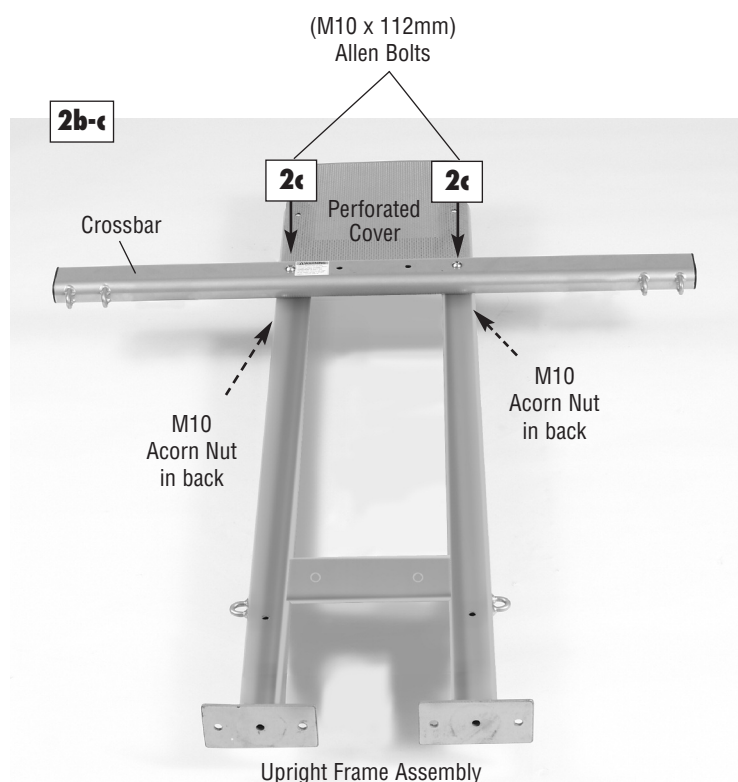

All nuts and bolts are installed front-to-rear – leaving the nut on the rear.

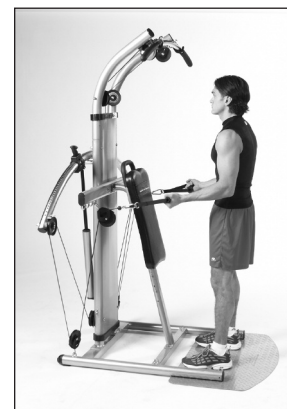

MUSCLE GROUPS EXERCISED: Triceps

LEVEL OF DIFFICULTY: Intermediate

102 TWO ARM REVERSE GRIP TRICEPS KICKBACK

START: Stand facing frame. Grip handles in underhand grip with palms facing up. Bend elbows 90 degrees.

MOTION: Extend elbows and pull handles down and back. Pause at end of motion. Bend elbows back to starting position.

TIPS: Keep arms close to sides of body. Do not allow wrists to bend while pressing back. Maintain upright posture throughout exercise. Do not lean forward while pressing back. Contract abdominals to stabilize torso.

SEAT: Off

LEG LIFT: Off

ACCESSORIES: Handles

MOVABLE PULLEY POSITIONS

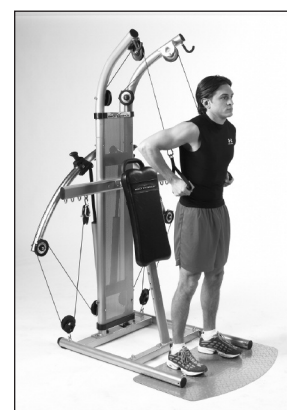
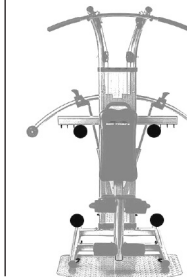

MUSCLE GROUPS EXERCISED: Triceps, anterior deltoids, pectoralis

LEVEL OF DIFFICULTY: Beginner

103 TRICEPS DIPS

START: Stand facing away. Grip handles at waist level. Bend elbows 90 degrees. Cables behind arms.

MOTION: Extend elbows and press handles down. Pause at end of motion. Bend elbows back to starting position.

TIPS: Keep arms close to sides of body. Press down and slightly forward. Maintain upright posture throughout exercise. Avoid rounding spine forward while pressing down. Contract abdominals to stabilize torso.

SEAT: Off

LEG LIFT: Off

ACCESSORIES: Handles/Lat Tower Position

MOVABLE PULLEY POSITIONS

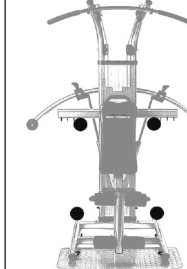

MUSCLE GROUPS EXERCISED: Triceps, anterior deltoids, pectoralis

LEVEL OF DIFFICULTY: Intermediate/Advanced

104 SINGLE ARM TRICEPS DIPS

START: Stand facing away. Grip one handle at waist level. Bend elbow 90 degrees. Cable behind arm.

MOTION: Extend elbow and press handle down. Pause at end of motion. Bend elbow back to starting position.

TIPS: Keep arm close to side of body. Press down and slightly forward. Maintain upright posture throughout exercise. Avoid rounding spine forward while pressing down. Contract abdominals to stabilize torso. Perform on both sides.

SEAT: Off

LEG LIFT: Off

ACCESSORIES: Handles/Lat Tower Position

MOVABLE PULLEY POSITIONS

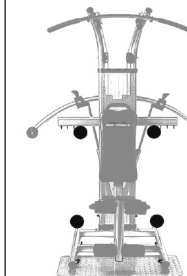



99 SINGLE ARM TRICEPS KICKBACK

START: Stand facing frame. Grip one handle in overhand grip with palm facing down. Bend elbow 90 degrees. Lean forward slightly and place other hand on seat back.

MOTION: Extend elbow and pull handle down and back. Pause at end of motion. Bend elbow back to starting position.

TIPS: Keep arm close to side of body. Do not allow wrist to bend while pressing back. Maintain straight spine while leaning forward. Contract abdominals to stabilize torso. Perform on both sides.

SEAT: Off

LEG LIFT: Off

ACCESSORIES:
Handles

MOVABLE PULLEY POSITIONS

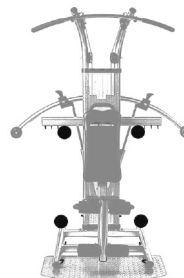

MUSCLE GROUPS EXERCISED: Triceps

LEVEL OF DIFFICULTY: Beginner



100 SINGLE ARM REVERSE GRIP TRICEPS KICKBACK

START: Stand facing frame. Grip one handle in underhand grip with palm facing up. Bend elbow 90 degrees. Lean forward slightly and place other hand on seat back.

MOTION: Extend elbow and pull handle down and back. Pause at end of motion. Bend elbow back to starting position.

TIPS: Keep arm close to side of body. Do not allow wrist to bend while pressing back. Maintain straight spine while leaning forward. Contract abdominals to stabilize torso. Perform on both sides.

SEAT: Off

LEG LIFT: Off

ACCESSORIES:
Handles

MOVABLE PULLEY POSITIONS

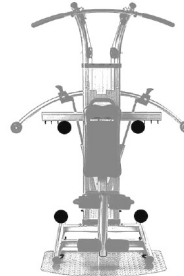

MUSCLE GROUPS EXERCISED: Triceps

LEVEL OF DIFFICULTY: Intermediate/Advanced



101 TWO ARM TRICEPS KICKBACK

START: Stand facing frame. Grip handles in overhand grip with palms facing down. Bend elbows 90 degrees.

MOTION: Extend elbows and pull handles down and back. Pause at end of motion. Bend elbows back to starting position.

TIPS: Keep arms close to sides of body. Do not allow wrists to bend while pressing back. Maintain upright posture throughout exercise. Do not lean forward while pressing back. Contract abdominals to stabilize torso.

SEAT: Off

LEG LIFT: Off

ACCESSORIES:
Handles

MOVABLE PULLEY POSITIONS

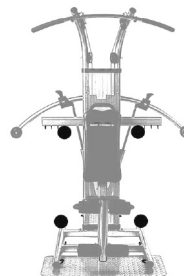

MUSCLE GROUPS EXERCISED: Triceps

LEVEL OF DIFFICULTY: Intermediate

Parts used in STEP 3

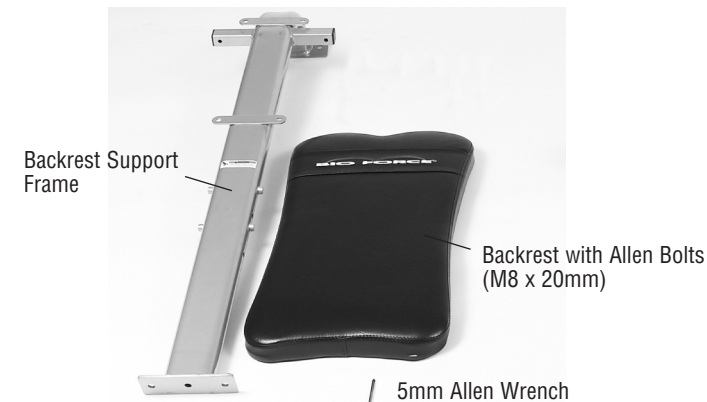

STEP 3 – Backrest Support Frame Assembly

- a. Turn the Backrest over and remove the bolts from the back.
 - b. Turn the Backrest Support Frame over so the Tabs are resting flat against the Backrest. Make sure the top of the Backrest (the end with the logo on it) is at the top end of the Backrest Support Frame (the end with the handle) as shown below and to the right.
- Secure the Backrest in place by inserting the 4 Allen Bolts you just removed in Step 3a through the Tabs on the Backrest Support Frame and into the Backrest. Tighten them using the Allen Wrench provided.



Completed Backrest Support Assembly

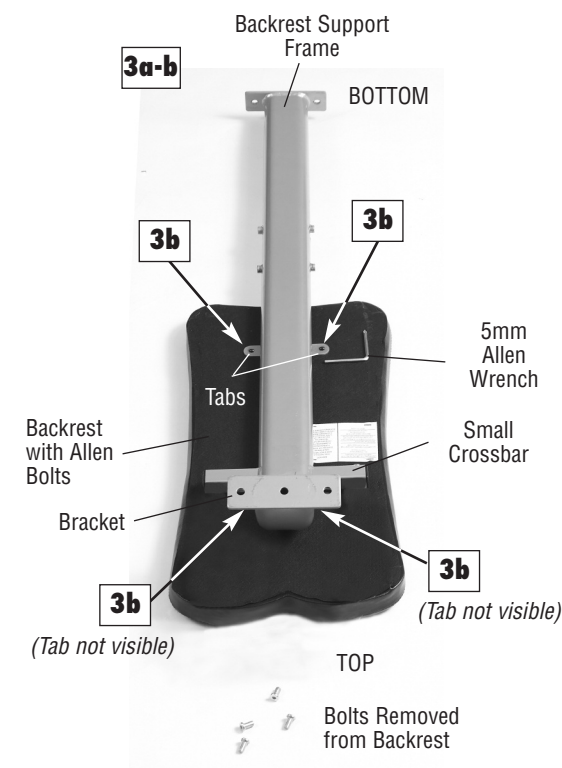

Parts used in STEP 4

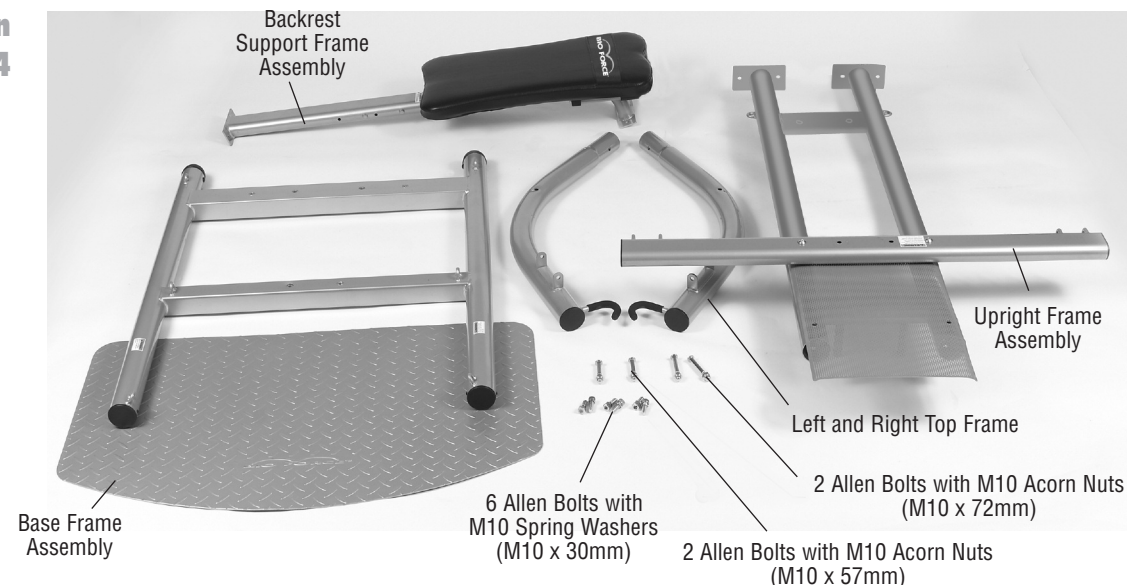

STEP 4 – Assembling the Main Frame Components

- a. Carefully lift the Upright Frame Assembly onto the rear cross member of the Base Frame Assembly making sure the Crossbar and Perforated Cover are facing the front. Secure it in place with 4 Allen Bolts with Spring Washers. Hand tighten.

CAUTION
Upright Frame Assembly is heavy. Use 2 people for Main Frame Assembly.

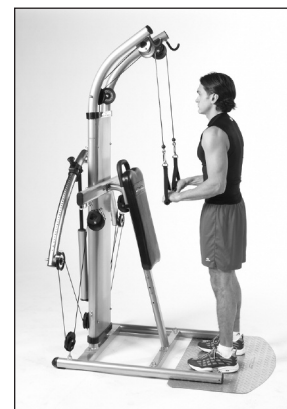
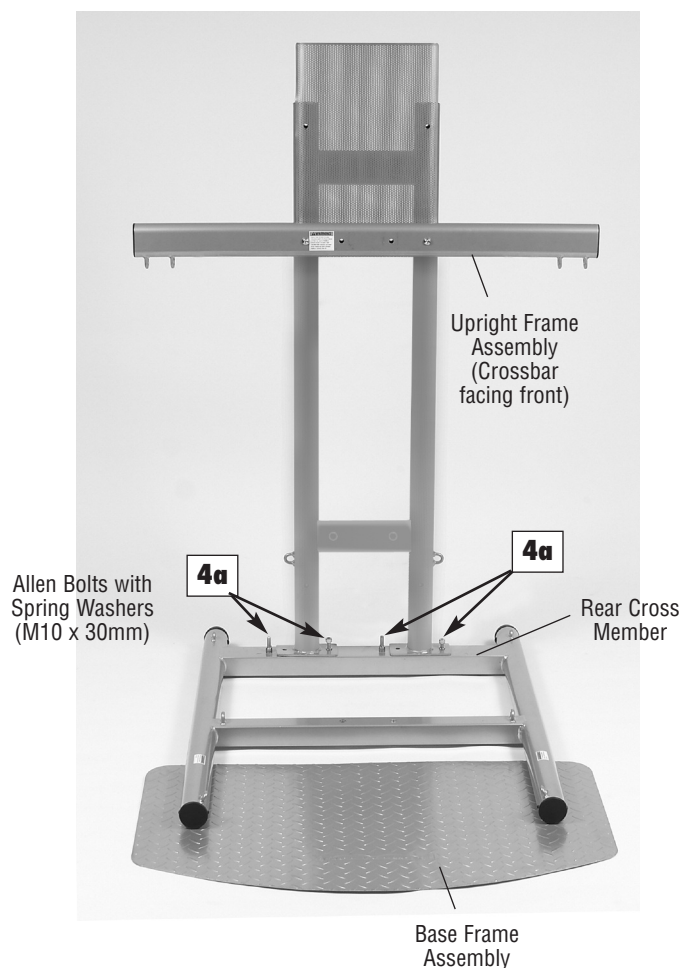

MUSCLE GROUPS EXERCISED: Triceps
LEVEL OF DIFFICULTY: Beginner



MUSCLE GROUPS EXERCISED: Triceps
LEVEL OF DIFFICULTY: Intermediate/Advanced



MUSCLE GROUPS EXERCISED: Triceps
LEVEL OF DIFFICULTY: Intermediate/Advanced



96 SPLIT GRIP TRICEPS PUSHDOWN

START: Stand facing frame. Feet hip width apart on base. Grip handles at waist level. Bend elbows 90 degrees.

MOTION: Extend elbows and press handles down. Pause at end of motion. Bend elbows back to starting position.

TIPS: Keep arms close to sides of body. Press handles down and slightly back. Maintain upright posture throughout exercise. Avoid rounding spine forward while pressing down. Contract abdominals to stabilize torso.

SEAT: Off
LEG LIFT: Off
ACCESSORIES: Handles/Lat Tower Position

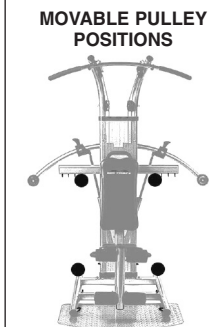

97 SINGLE ARM TRICEPS PUSHDOWN

START: Stand facing frame. Feet hip width apart on base. Grip one handle in overhand grip with palm facing down. Bend elbow 90 degrees.

MOTION: Extend elbow and press handle down toward thigh. Pause at bottom of motion. Bend elbow back to starting position.

TIPS: Hold elbow at side of ribcage. Do not move upper arm while extending elbow. Maintain upright posture throughout exercise. Avoid rounding spine forward while pressing down. Contract abdominals to stabilize torso. Perform on both sides.

SEAT: Off
LEG LIFT: Off
ACCESSORIES: Handles/Lat Tower Position

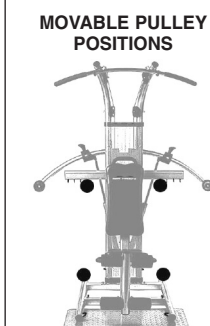

98 SINGLE ARM REVERSE GRIP TRICEPS PUSHDOWN

START: Stand facing frame. Feet hip width apart on base. Grip one handle in underhand grip with palm facing up. Bend elbow 90 degrees.

MOTION: Extend elbow and press handle down toward thigh. Pause at bottom of motion. Bend elbow back to starting position.

TIPS: Hold elbow at side of ribcage. Do not move upper arm while extending elbow. Maintain upright posture throughout exercise. Avoid rounding spine forward while pressing down. Contract abdominals to stabilize torso. Perform on both sides.

SEAT: Off
LEG LIFT: Off
ACCESSORIES: Handles/Lat Tower Position

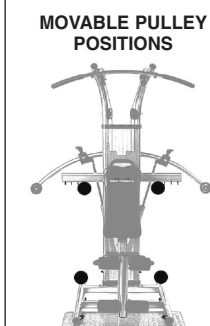



93 SINGLE ARM OVERHEAD TRICEPS EXTENSION

START: Sit facing away. Grip one handle behind head. Point elbow front at shoulder height.

MOTION: Extend elbow and press handle overhead. Pause at top of motion. Bend elbow back to starting position.

TIPS: Keep elbow in start position throughout exercise. Do not open elbow to side. Maintain upright posture in seated position. Avoid tilting or rotating to one side while extending arm. Contract abdominals to stabilize torso. Perform on both sides.

SEAT: On/Top Position

LEG LIFT: On

ACCESSORIES: Handles

MOVABLE PULLEY POSITIONS

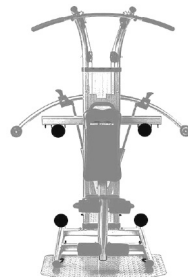

MUSCLE GROUPS EXERCISED: Triceps

LEVEL OF DIFFICULTY: Intermediate/Advanced



94 STANDING TRICEPS PUSHDOWN

START: Stand facing frame. Feet hip width apart on base. Grip lat bar in overhand, shoulder width grip with palms facing down. Bend elbows 90 degrees.

MOTION: Extend elbows and press bar down toward thighs. Pause at bottom of motion. Bend elbows back to starting position.

TIPS: Hold elbows at sides of ribcage. Do not move upper arms while extending elbows. Maintain upright posture throughout exercise. Avoid rounding spine forward while pressing down. Contract abdominals to stabilize torso.

SEAT: Off

LEG LIFT: Off

ACCESSORIES: Lat Bar/Lat Tower Position

MOVABLE PULLEY POSITIONS

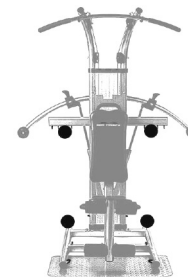

MUSCLE GROUPS EXERCISED: Triceps

LEVEL OF DIFFICULTY: Beginner

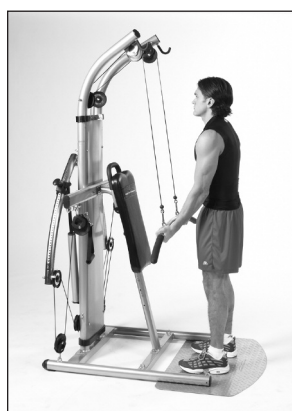
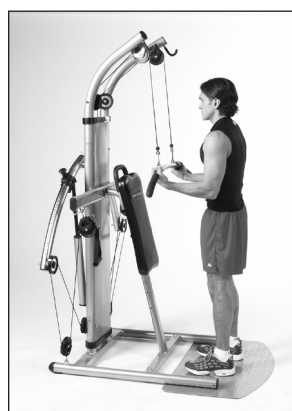

95 REVERSE GRIP TRICEPS PUSHDOWN

START: Stand facing frame. Feet hip width apart on base. Grip lat bar in underhand, shoulder width grip with palms facing up. Bend elbows 90 degrees.

MOTION: Extend elbows and press bar down toward thighs. Pause at bottom of motion. Bend elbows back to starting position.

TIPS: Hold elbows at sides of ribcage. Do not move upper arms while extending elbows. Maintain upright posture throughout exercise. Avoid rounding spine forward while pressing down. Contract abdominals to stabilize torso.

SEAT: Off

LEG LIFT: Off

ACCESSORIES: Lat Bar/Lat Tower Position

MOVABLE PULLEY POSITIONS

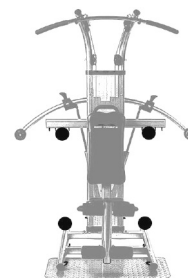

MUSCLE GROUPS EXERCISED: Triceps

LEVEL OF DIFFICULTY: Intermediate

b. Set the Backrest Support Frame Assembly in place by aligning the holes in the bottom with the holes in the Center Cross Member of the Base Frame Assembly. Secure it in place with 2 Allen Bolts with Spring Washers. Hand tighten.

c. Align the holes in the top of the Backrest Support Frame and the center holes in the Crossbar. Insert 2 Allen Bolts and add Acorn Nuts. Hand tighten.

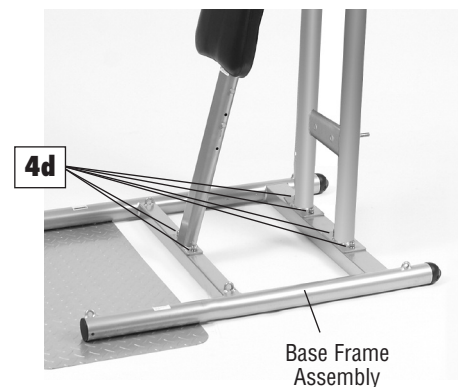
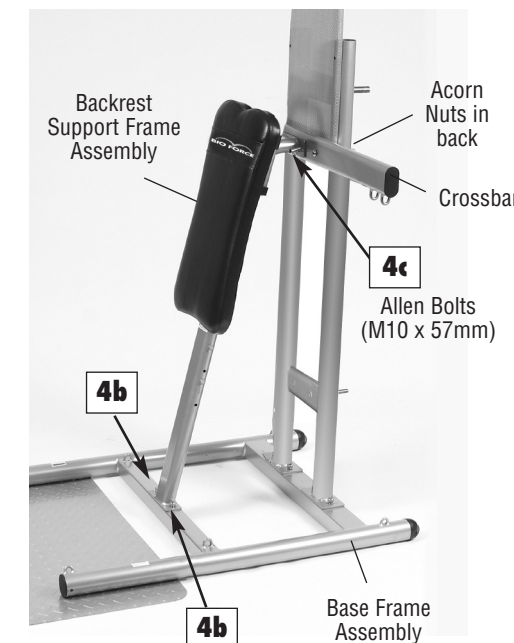

d. With the Allen Wrench, tighten the 6 Base Frame Bolts at this time.

Allen Bolt with Spring Washers (M10 x 30mm)

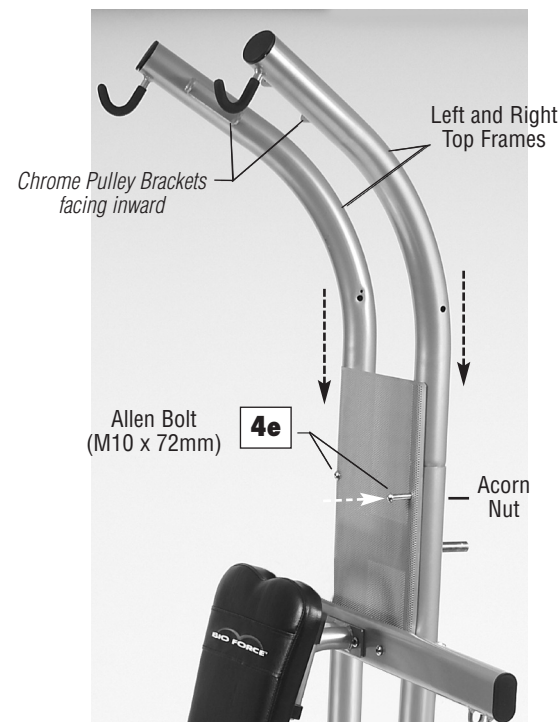

e. Insert the Left and Right Top Frame into the top of the Upright Frame with the Chrome Pulley Brackets facing inward. Secure them with 2 Allen Bolts and Acorn Nuts. Hand Tighten.

All nuts and bolts installed front-to-rear – leaving the nut on the rear.

Parts used in STEP 5

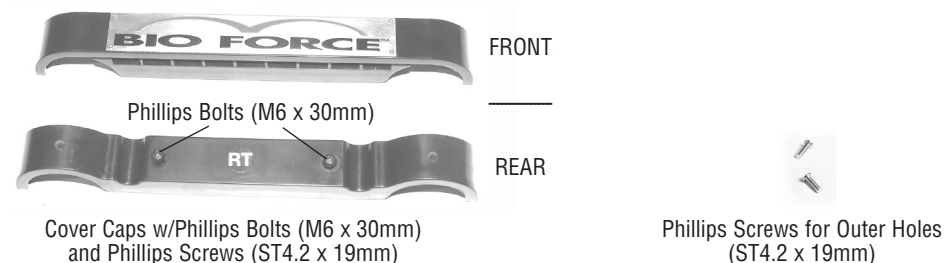

STEP 5 – Cover Cap Installation

- a. Remove the 2 (M6 x 30mm) Phillips Bolts from the Top Cover Cap for the Perforated Cover with the Phillips Screwdriver provided, and separate the front & rear sections.
Note: The Cover Cap with the Bio Force® Logo goes on the top front.
- b. Place the Top Cover Cap on by sliding the groove in it over the edge of the Perforated Cover. You may need to tap it into place.
Set the rear of the Top Cover Cap in place. Secure the two together using the 2 (M6 x 30mm) Phillips Bolts you just removed in Step 5a and inserting them back into the 2 center holes.
Secure the Rear Cover Cap to the Frame with 2 (ST4.2 x 19mm) Phillips Screws, inserting into the 2 outer holes. Tighten the bolts using the Phillips Screwdriver provided.

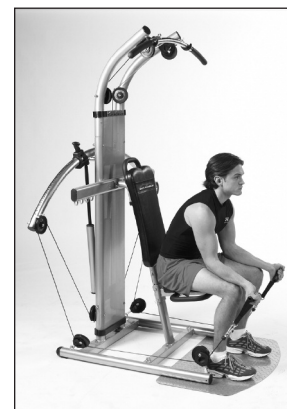
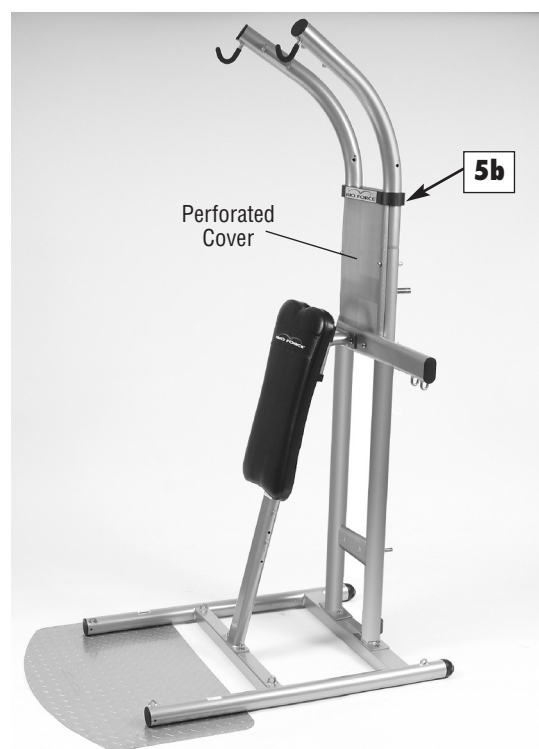

MUSCLE GROUPS EXERCISED: Forearm flexors
LEVEL OF DIFFICULTY: Beginner



MUSCLE GROUPS EXERCISED: Forearm extensors
LEVEL OF DIFFICULTY: Beginner



MUSCLE GROUPS EXERCISED: Triceps
LEVEL OF DIFFICULTY: Intermediate



90 SEATED WRIST CURL
START: Sit facing away. Lean forward and rest forearms on lower thighs. Grip handles in underhand grip with palms facing up and wrists extended.
MOTION: Flex wrists and curl handles toward forearms. Pause at top of motion. Extend wrists to starting position.
TIPS: Lean forward with straight back. Do not round upper or lower spine. Avoid bending elbows or lifting forearms while flexing wrists. Contract abdominals to stabilize torso.

91 SEATED REVERSE WRIST CURL
START: Sit facing away. Lean forward and rest forearms on lower thighs. Grip handles in overhand grip with palms facing down and wrists flexed.
MOTION: Extend wrists and curl handles toward forearms. Pause at top of motion. Flex wrists to starting position.
TIPS: Lean forward with straight back. Do not round upper or lower spine. Avoid bending elbows or lifting forearms while extending wrists. Contract abdominals to stabilize torso.

92 SEATED OVERHEAD TRICEPS EXTENSION
START: Sit facing away. Grip handles behind head. Point elbows front at shoulder height.
MOTION: Extend elbows and press handles overhead. Pause at top of motion. Bend elbows back to starting position.
TIPS: Keep elbows in start position throughout exercise. Do not open elbows to sides. Keep wrists straight. Maintain upright posture in seated position. Contract abdominals to stabilize torso.

SEAT: On/Bottom Position
LEG LIFT: Off
ACCESSORIES: Handles

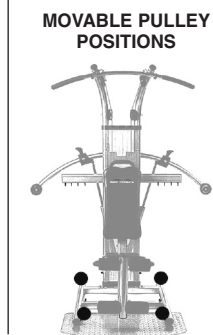

SEAT: On/Bottom Position
LEG LIFT: Off
ACCESSORIES: Handles

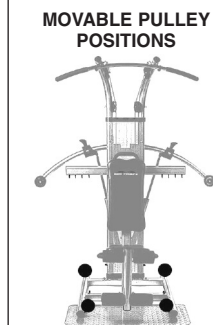

SEAT: On/Top Position
LEG LIFT: On
ACCESSORIES: Handles

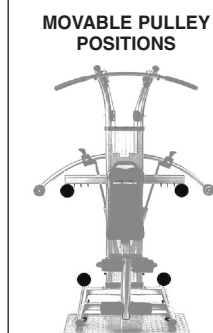

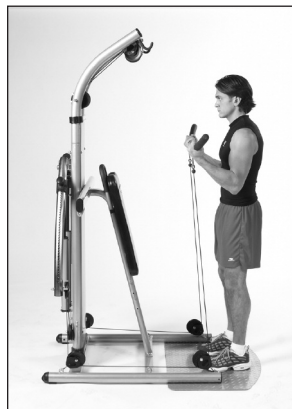

87 CURVED BAR BICEPS CURL

START: Stand facing frame. Feet hip width apart on base. Grip lat bar in underhand grip with thumbs facing outward.

MOTION: Bend elbows and curl bar toward front of shoulders. Pause at top of motion. Lower arms to starting position.

TIPS: Hold elbows at sides of ribcage. Do not swing elbows forward while curling. Maintain upright posture throughout exercise. Avoid tilting torso back while curling arms. Contract abdominals to stabilize torso.

MUSCLE GROUPS EXERCISED: Biceps, forearm flexors

LEVEL OF DIFFICULTY: Beginner

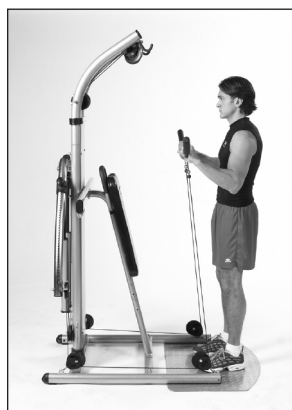
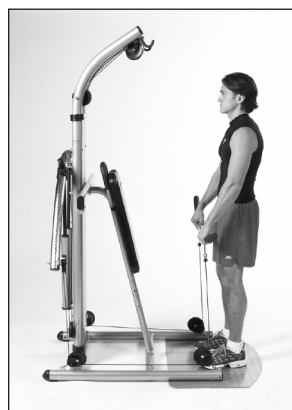

88 CURVED BAR REVERSE BICEPS CURL

START: Stand facing frame. Feet hip width apart on base. Grip lat bar in overhand grip with thumbs facing inward.

MOTION: Bend elbows and curl bar toward front of shoulders. Pause at top of motion. Lower arms to starting position.

TIPS: Hold elbows at sides of ribcage. Do not swing elbows forward while curling. Maintain upright posture throughout exercise. Avoid tilting torso back while curling arms. Contract abdominals to stabilize torso.

MUSCLE GROUPS EXERCISED: Biceps, forearm extensors

LEVEL OF DIFFICULTY: Intermediate



89 SEATED CONCENTRATION CURL

START: Sit facing away. Lean forward and rest one arm on inside of knee. Grip one handle in underhand grip with palm facing up.

MOTION: Bend elbow and curl handle toward front of shoulder. Pause at top of motion. Lower arm to starting position.

TIPS: Lean forward with straight back. Do not round upper or lower spine. Hold upper arm in stable position on leg. Contract abdominals to stabilize torso. Perform on both sides.

MUSCLE GROUPS EXERCISED: Biceps, forearm flexors

LEVEL OF DIFFICULTY: Beginner

SEAT: Off
LEG LIFT: Off
ACCESSORIES: Lat Bar/Front Position

MOVABLE PULLEY POSITIONS

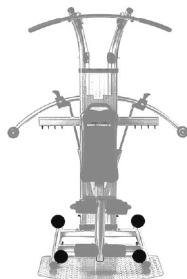

SEAT: Off
LEG LIFT: Off
ACCESSORIES: Lat Bar/Front Position

MOVABLE PULLEY POSITIONS

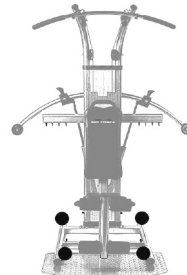

SEAT: On/Bottom Position
LEG LIFT: Off
ACCESSORIES: Handles

MOVABLE PULLEY POSITIONS

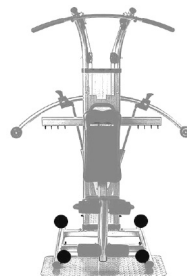

Parts used in STEP 6 & 7

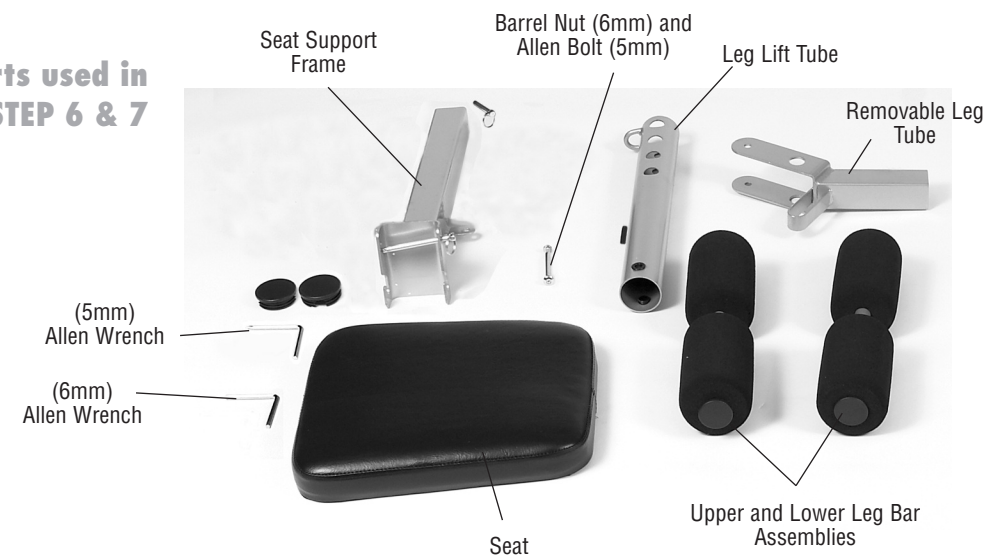

STEP 6 – Seat Assembly

a. Remove the bolts from the bottom of the seat.

Lay the Seat Support Frame on the bottom of the Seat making sure the Long Hitch Pin and Bracket are facing the same direction as the narrow end of the Seat.

Insert the 4 Allen Bolts you just removed from the bottom of the Seat. Tighten using the Allen Wrench (5mm) provided.

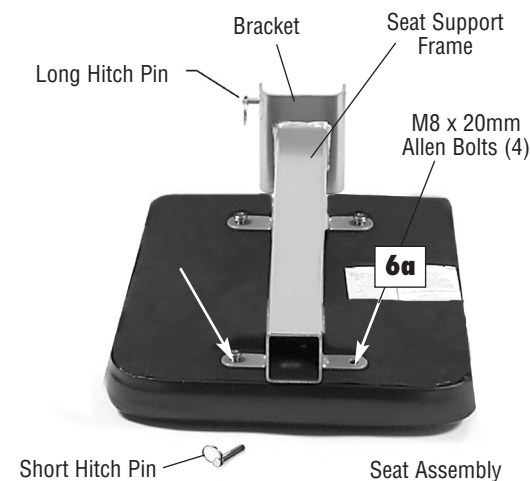

Removable Leg Tube Bracket



b. Remove the Long Hitch Pin from the Seat Support Frame Assembly.

Hang the Seat Assembly on the top studs of the Backrest Support Frame.

IMPORTANT: Make sure the Bracket on the Seat Assembly is securely over the stud.

Insert the Long Hitch Pin through the holes under the studs to secure the Seat Assembly in place.

c. Remove the Short Hitch Pin from the Seat Support Frame Assembly.

Slide the Removable Leg Tube into the open end of the Seat Assembly with the Bracket as shown.

Re-insert the Short Hitch Pin through the holes in the Seat Assembly and Removable Leg Tube.



STEP 7 – Foot Tube Assembly

- a. Place the top of the Leg Lift Tube into the Bracket on the Removable Leg Tube.
 Note: The holes, in the top of the Leg Lift Tube, have bushings in them, and the warning label is facing the seat.
 Insert the Barrel Nut through the Removable Leg Tube and the Leg Lift Tube. Add the Allen Bolt and tighten it using the Allen Wrenches (5 & 6mm) provided.



- b. Remove the Leg Bar Cap and Foam Pad from one end of the Upper Leg Bar and insert it through the holes in the middle of the bracket on the Removable Leg Tube.
 Replace the Foam Pad and Leg Bar Cap.
IMPORTANT: Make sure the Leg Bar Cap is all the way on the Leg Bar.
 Note: The Upper Leg Bar is longer than the lower one.
- c. Remove the Leg Bar Cap and Foam Pad from one end of the Lower Leg Bar. Insert it through a set of holes in the bottom of the Leg Lift Tube.
 Replace the Foam Pad and Leg Bar Cap. (Twist to remove easily.)

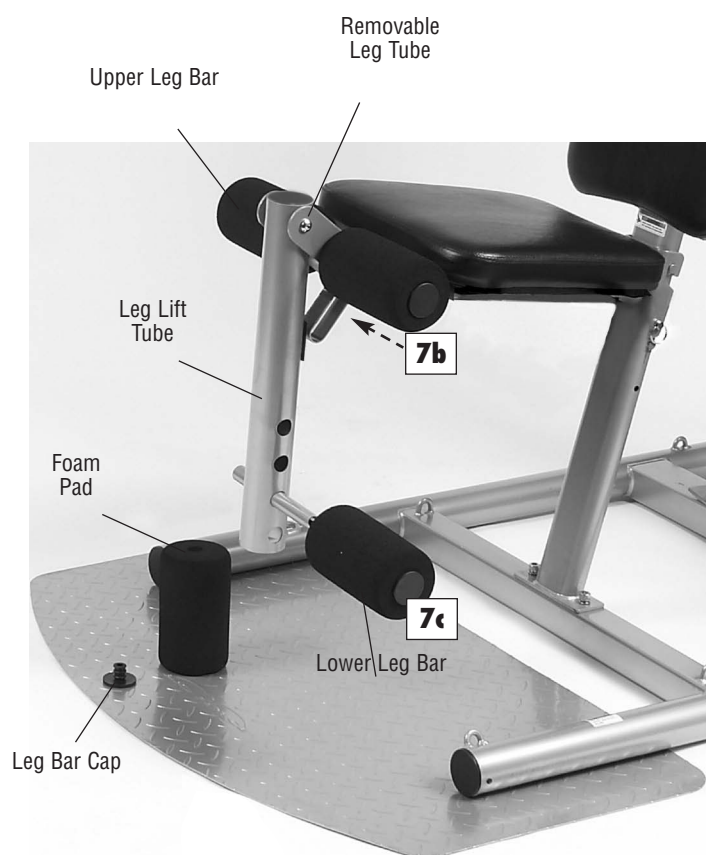

Note: See Page 29 for appropriate Leg Bar Adjustment.

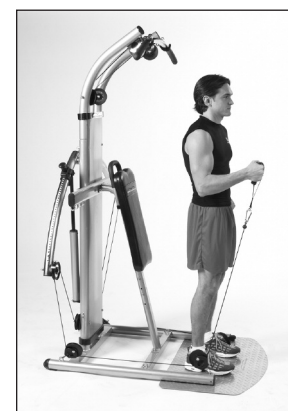
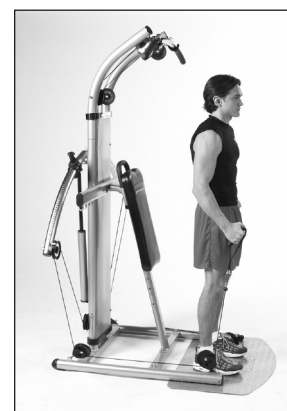

84 SINGLE ARM STANDING HAMMER CURL

START: Stand facing away. Feet hip width apart on base. Grip one handle in neutral grip with thumb facing forward.
MOTION: Bend elbow and curl handle toward front of shoulder. Pause at top of motion. Lower arm to starting position.
TIPS: Hold elbow at side of ribcage. Do not swing elbow forward while curling. Maintain upright posture throughout exercise. Avoid tilting torso to one side while curling arm. Contract abdominals to stabilize torso. Perform on both sides.

MUSCLE GROUPS EXERCISED: Biceps, forearm extensors
LEVEL OF DIFFICULTY: Intermediate/Advanced

SEAT: Off
LEG LIFT: Off
ACCESSORIES: Handles

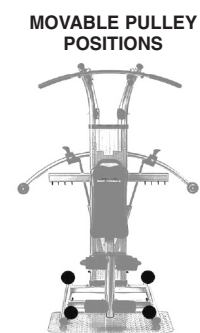

85 STANDING REVERSE CURL

START: Stand facing away. Feet hip width apart on base. Grip handles in overhand grip with thumbs facing inward.
MOTION: Bend elbows and curl handles toward front of shoulders. Pause at top of motion. Lower arms to starting position.
TIPS: Hold elbows at sides of ribcage. Do not swing elbows forward while curling. Maintain upright posture throughout exercise. Avoid tilting torso back while curling arms. Contract abdominals to stabilize torso.

MUSCLE GROUPS EXERCISED: Biceps, forearm extensors
LEVEL OF DIFFICULTY: Intermediate

SEAT: Off
LEG LIFT: Off
ACCESSORIES: Handles

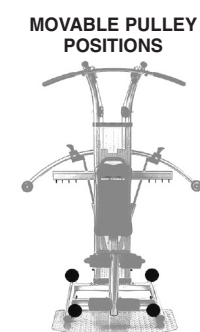

86 SINGLE ARM STANDING REVERSE CURL

START: Stand facing away. Feet hip width apart on base. Grip one handle in overhand grip with thumb facing inward.
MOTION: Bend elbow and curl handle toward front of shoulder. Pause at top of motion. Lower arm to starting position.
TIPS: Hold elbow at side of ribcage. Do not swing elbow forward while curling. Maintain upright posture throughout exercise. Avoid tilting torso to one side while curling arm. Contract abdominals to stabilize torso. Perform on both sides.

MUSCLE GROUPS EXERCISED: Biceps, forearm extensors
LEVEL OF DIFFICULTY: Intermediate/Advanced

SEAT: Off
LEG LIFT: Off
ACCESSORIES: Handles

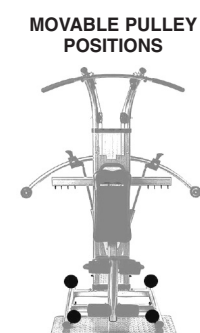

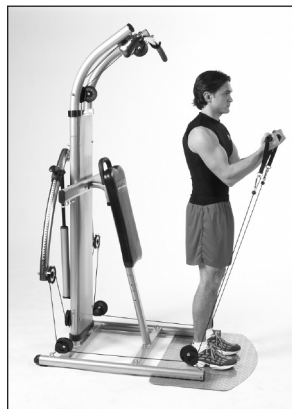

81 STANDING BICEPS CURL

START: Stand facing away. Feet hip width apart on base. Grip handles in underhand grip with thumbs facing outward.

MOTION: Bend elbows and curl handles toward front of shoulders. Pause at top of motion. Lower arms to starting position.

TIPS: Hold elbows at sides of ribcage. Do not swing elbows forward while curling. Maintain upright posture throughout exercise. Avoid tilting torso back while curling arms. Contract abdominals to stabilize torso.

SEAT: Off

LEG LIFT: Off

ACCESSORIES:
Handles

MOVABLE PULLEY POSITIONS

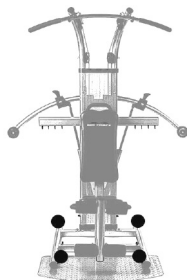

MUSCLE GROUPS EXERCISED: Biceps, forearm flexors

LEVEL OF DIFFICULTY: Beginner

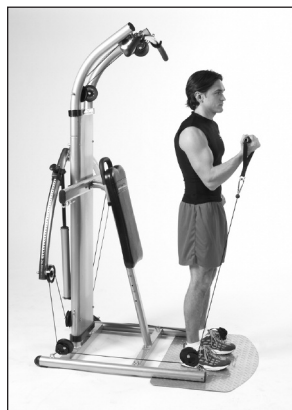

82 SINGLE ARM STANDING BICEPS CURL

START: Stand facing away. Feet hip width apart on base. Grip one handle in underhand grip with thumb facing outward.

MOTION: Bend elbow and curl handle toward front of shoulder. Pause at top of motion. Lower arm to starting position.

TIPS: Hold elbow at side of ribcage. Do not swing elbow forward while curling. Maintain upright posture throughout exercise. Avoid tilting torso to one side while curling arm. Contract abdominals to stabilize torso. Perform on both sides.

SEAT: Off

LEG LIFT: Off

ACCESSORIES:
Handles

MOVABLE PULLEY POSITIONS

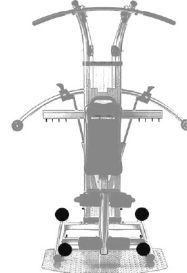

MUSCLE GROUPS EXERCISED: Biceps, forearm flexors

LEVEL OF DIFFICULTY: Intermediate/Advanced

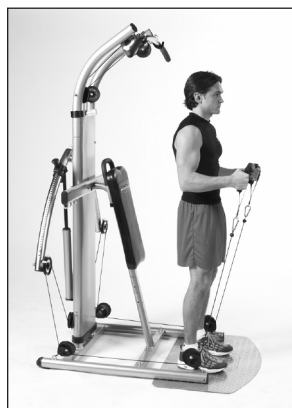

83 STANDING HAMMER CURL

START: Stand facing away. Feet hip width apart on base. Grip handles in neutral grip with thumbs facing forward.

MOTION: Bend elbows and curl handles toward front of shoulders. Pause at top of motion. Lower arms to starting position.

TIPS: Hold elbows at sides of ribcage. Do not swing elbows forward while curling. Maintain upright posture throughout exercise. Avoid tilting torso back while curling arms. Contract abdominals to stabilize torso.

SEAT: Off

LEG LIFT: Off

ACCESSORIES:
Handles

MOVABLE PULLEY POSITIONS

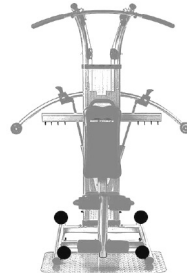

MUSCLE GROUPS EXERCISED: Biceps, forearm extensors

LEVEL OF DIFFICULTY: Beginner

Parts used in STEP 8

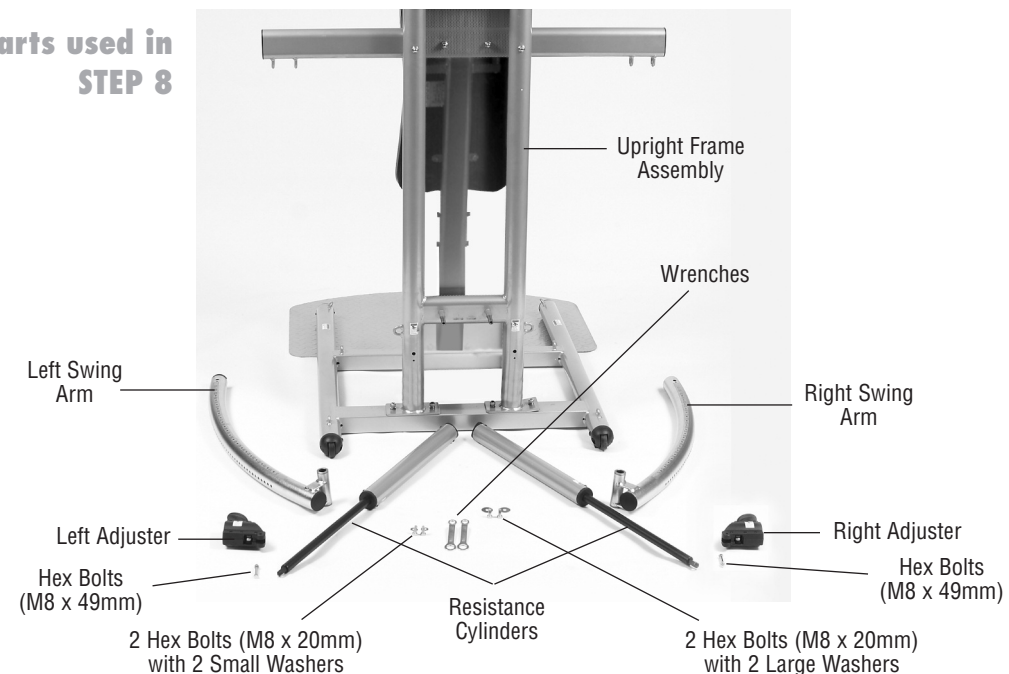

STEP 8 – Installing the Swing Arms and Cylinders

Standing behind the Bio Force® Sport exerciser

- a. Take off the Stopper, With the calibration numbers to the front, slide the Right Swing Arm onto the Support Rod on the top cross member of the Upright Frame. Use a Large Flat Washer and the Hex Bolt to secure the Right Swing Arm and tighten it using the 13mm Wrench.
- b. Lift the Knob on the Right Adjuster while sliding it onto the Swing Arm. Slide it to the number 20. The numbers are marked on the front of the Swing Arm. The left or right will be indicated just below the Knob on the Adjuster's rear side and the calibration number must show through the window in the front of the Adjuster.

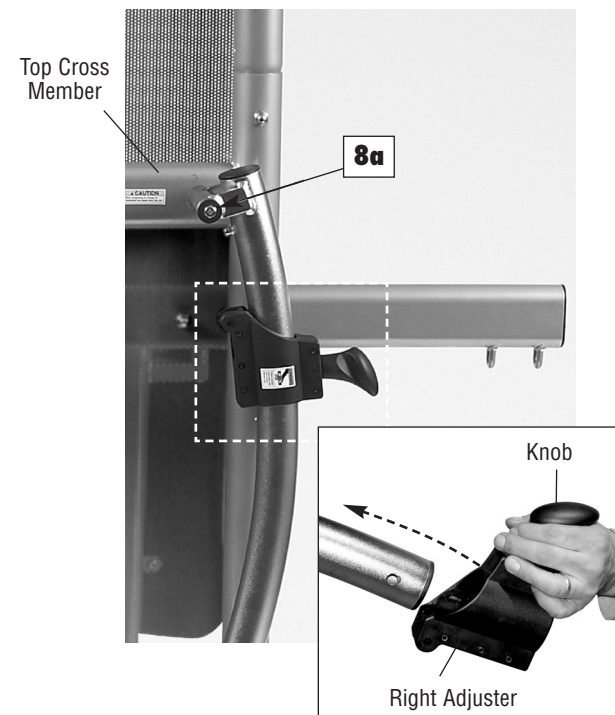

- c. With the warning label facing out, place the bottom of the Resistance Cylinder on the Support Rod of the lower cross member of the Upright Frame with the top of the Cylinder laying out to the right of the unit. Use one of the Small Flat Washers and Hex Bolts to secure the bottom of the Resistance Cylinder. Tighten the Bolt with Wrench provided.

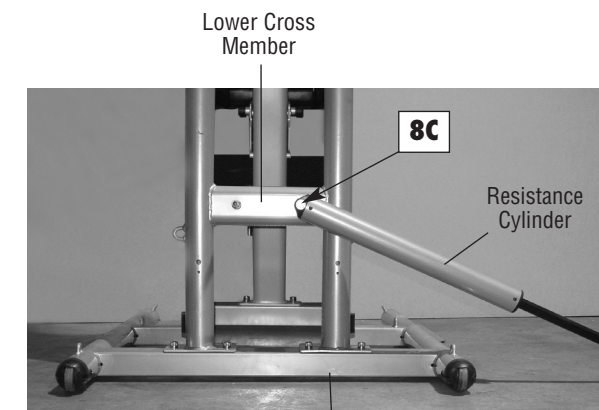

Base Frame Assembly

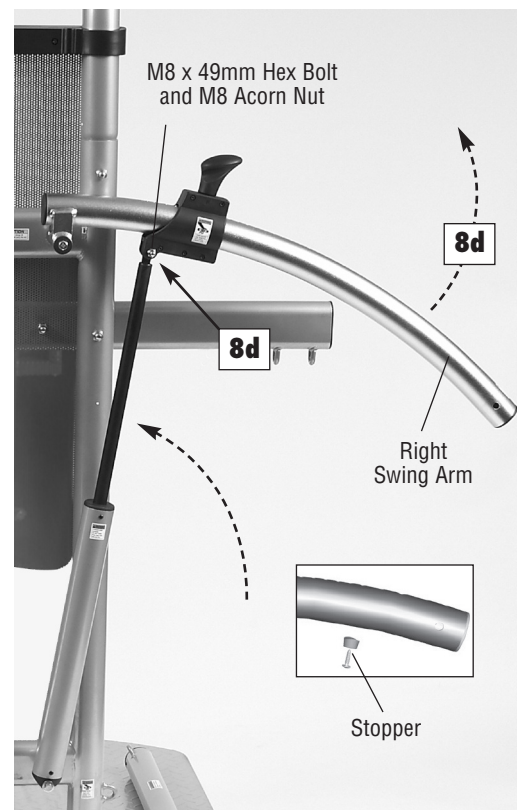

All nuts and bolts are installed front-to-rear – leaving the nut on the rear.

- d. Lift the Right Swing Arm and the Resistance Cylinder to align the top of the Cylinder to the bottom of the Right Adjuster. Align the two pieces and connect with a Hex Bolt and Acorn Nut making sure the Nut is to the rear. Then fix the Stopper in place. Tighten it with the Wrenches provided.
- e. Repeat Step 8a - d for the Left side.

STEP 9 – Attaching Pulleys

Parts used in STEP 9

- 12 Cable Guides
- 10 Small Bushings
- 2 Large Bushings

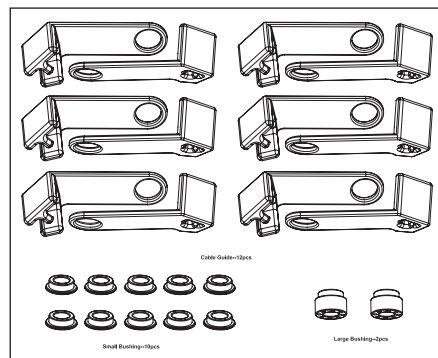

- 6 Allen Bolts (M10 x 107mm)
- 6 Acorn Nuts (M10)
- 6 Pulleys

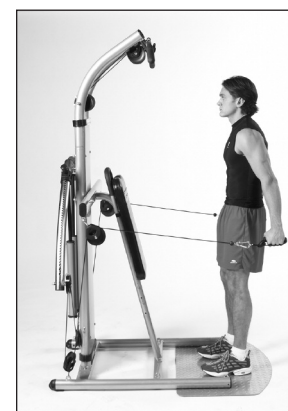
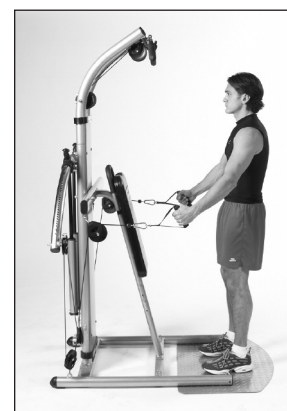

78 STRAIGHT ARM PULL-BACK

START: Stand facing frame. Feet hip width apart on base. Grip handles in front of body with thumbs facing up.

MOTION: Pull arms straight back behind body. Pause at end of motion. Return to starting position.

TIPS: Keep elbows straight. Maintain upright posture throughout exercise. Do not lean or tilt forward. Keep wrists straight while pulling back. Contract abdominals to stabilize torso. Perform on both sides.

MUSCLE GROUPS EXERCISED: Posterior deltoids, latissimus
LEVEL OF DIFFICULTY: Beginner

SEAT: Off
LEG LIFT: Off
ACCESSORIES: Handles

MOVABLE PULLEY POSITIONS

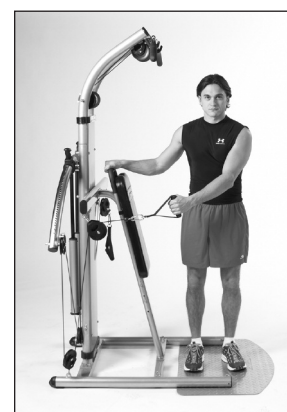
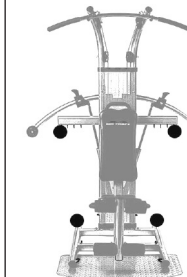

79 ROTATOR CUFF - DIAGONAL EXTERNAL ROTATION

START: Stand facing side. Grip handle across body with outside arm. Grip back of seat with inside hand.

MOTION: Externally rotate shoulder, pulling arm diagonally across body. Pause at end of motion. Return to starting position.

TIPS: Keep elbow almost straight while opening arm. Do not bend wrist. Keep shoulders square. Do not rotate torso to one side. Contract abdominals to stabilize torso. Perform on both sides.

MUSCLE GROUPS EXERCISED: External shoulder rotators
LEVEL OF DIFFICULTY: Intermediate

SEAT: Off
LEG LIFT: Off
ACCESSORIES: Handles

MOVABLE PULLEY POSITIONS

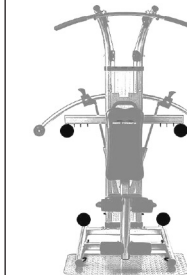

80 ROTATOR CUFF - DIAGONAL INTERNAL ROTATION

START: Stand facing side. Grip handle in front of body with inside arm. Place outside hand on hip.

MOTION: Internally rotate shoulder, pulling arm diagonally across body. Pause at end of motion. Return to starting position.

TIPS: Keep elbow almost straight while pulling arm across body. Do not bend wrist. Keep shoulders square. Do not rotate torso to one side. Contract abdominals to stabilize torso. Perform on both sides.

MUSCLE GROUPS EXERCISED: Internal shoulder rotators
LEVEL OF DIFFICULTY: Intermediate

SEAT: Off
LEG LIFT: Off
ACCESSORIES: Handles

MOVABLE PULLEY POSITIONS

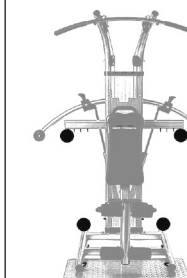

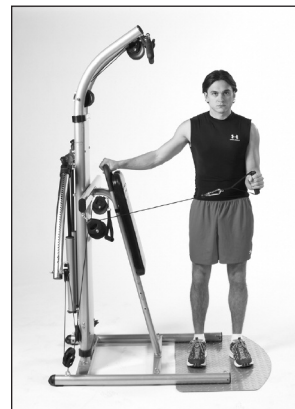

75 ROTATOR CUFF - LOW EXTERNAL ROTATION

START: Stand facing side. Bend outside elbow 90 degrees and grip handle in front of waist. Grip back of seat with inside hand.

MOTION: Externally rotate arm to outside. Pause at end of motion. Return to starting position.

TIPS: Keep elbow against body while rotating shoulder. Avoid lifting upper arm away from torso. Keep shoulders square. Do not rotate torso to one side. Contract abdominals to stabilize torso. Perform on both sides.

SEAT: Off

LEG LIFT: Off

ACCESSORIES: Handles

MOVABLE PULLEY POSITIONS

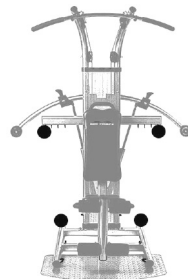

MUSCLE GROUPS EXERCISED: External shoulder rotators

LEVEL OF DIFFICULTY: Beginner

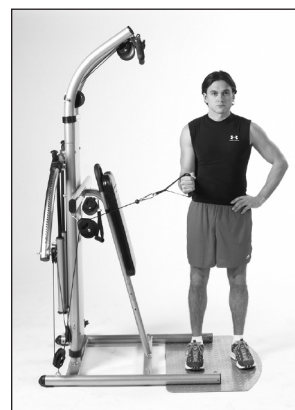

76 ROTATOR CUFF - INTERNAL ROTATION

START: Stand facing side. Bend inside elbow 90 degrees and grip handle in front of waist. Place outside hand on hip.

MOTION: Internally rotate arm across body. Pause at end of motion. Return to starting position.

TIPS: Keep elbow against body while rotating shoulder. Avoid pulling upper arm across torso. Keep shoulders square. Do not rotate torso to one side. Contract abdominals to stabilize torso. Perform on both sides.

SEAT: Off

LEG LIFT: Off

ACCESSORIES: Handles

MOVABLE PULLEY POSITIONS

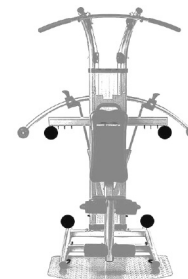

MUSCLE GROUPS EXERCISED: Internal shoulder rotators

LEVEL OF DIFFICULTY: Beginner

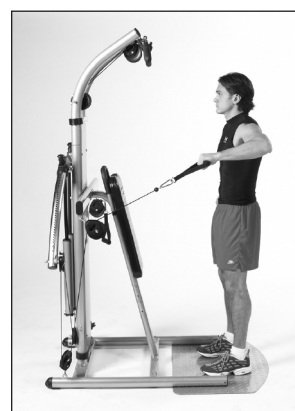

77 ROTATOR CUFF - HIGH EXTERNAL ROTATION

START: Stand facing frame. Feet hip width apart on base. Bend one elbow 90 degrees at shoulder. Grip handle with palm facing down.

MOTION: Externally rotate shoulder, pulling hand above elbow. Pause at top of motion. Return to starting position.

TIPS: Hold elbow at shoulder height while rotating. Keep wrist straight. Do not pull arm back or rotate torso. Contract abdominals to stabilize torso. Perform on both sides.

SEAT: Off

LEG LIFT: Off

ACCESSORIES: Handles

MOVABLE PULLEY POSITIONS

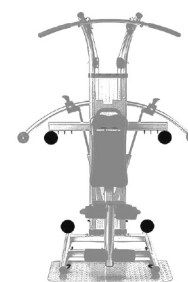

MUSCLE GROUPS EXERCISED: External shoulder rotators

LEVEL OF DIFFICULTY: Intermediate

- Take the 2 Pulleys without the Bio Force® Logos, 4 Small Bushings, 4 Cable Guides and bolt them to the bottom rear of the Frame using 2 Allen Bolts and 2 Acorn Nuts.
NOTE: Position flat side of Cable Guide away from Pulley. See photo 9a.
- Use 4 Small Bushings, 4 Cable Guides and 2 Pulleys with Bio Force® Logos and mount them to the Top Frame with the logos facing each other. Use the 2 Allen Bolts and 2 Acorn Nuts specified.
NOTE: Position flat side of Cable Guide away from Pulley. See photo 9b.
- Use 2 Small Bushings, 2 Large Bushings, 4 Cable Guides and 2 Pulleys with Bio Force® Logos and mount them near the ends of the Swing Arms - with the Logo facing out to the front and the Large Bushings between the Cable Guide and the Swing Arms. Use the 2 Allen Bolts and 2 Acorn Nuts specified, making sure the Nut is to the rear.
NOTE: Position flat side of Cable Guide away from Pulley. See photo 9c.

NOTE: For Steps 9a-c – All Nuts and Bolts are installed front-to-rear – leaving the Nut on the rear.

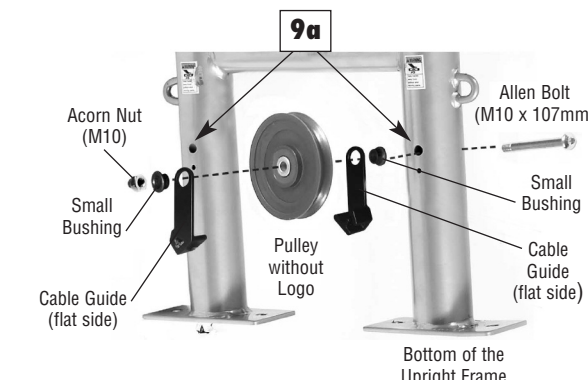
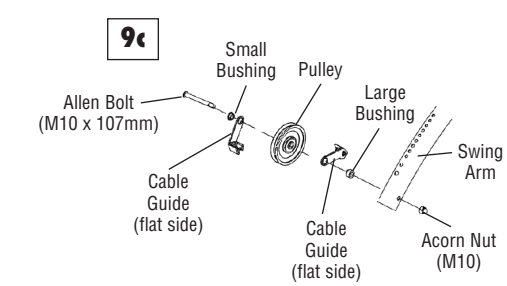
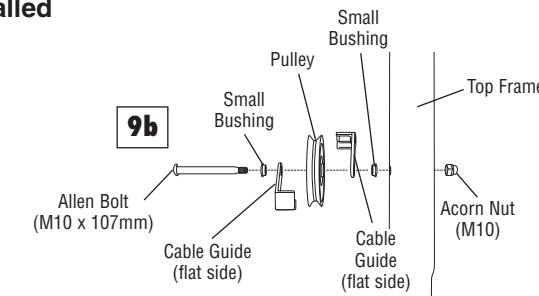

Parts used in STEP 10

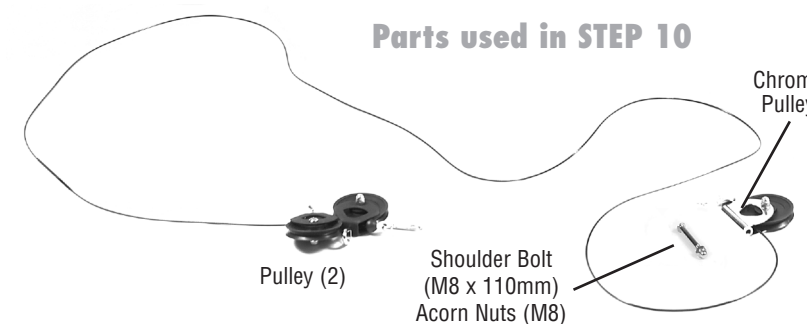

STEP 10 – Cable Assemblies

- Stretch out and untangle the Cable. Slide the Chrome Pulley to one end of the Cable. Slide the other 2 Pulleys to the other end of the Cable. This will help keep the Cable untangled during stringing.

(continued on next page)

M8 x 110mm
Shoulder Bolt
Large Clip

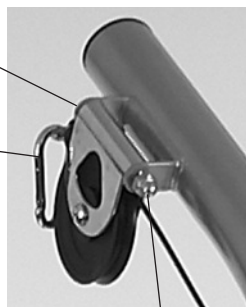

M8 Acorn Nut

- b.** Using a Shoulder Bolt and Acorn Nut, attach the Chrome Pulley to the Bracket on the right Top Frame as shown. Keep the Large Clip to the front and the Nut toward the rear. The Chrome Pulley must be able to swivel.

String the Cable down over the Pulley on the Top Frame, just above the Perforated Cover.

Note: You may need a step ladder to reach this high.

- 1.** Guide the Cable through the Rear Cable Guide **first**, then through the Front Cable Guide. The Cable must be to the outside of the Top and Bottom Support Rods and to the inside of the bottom rear Pulley.
 - 2.** Go around the bottom Pulley by stringing the Cable through the Front Cable Guide. Then string the Cable through the Rear Cable Guide.
 - 3.** String the Cable to the inside of the Swing Arm Pulley by feeding the Cable through the Front Cable Guide **first**, then through the Rear Cable Guide.
 - 4.** Hook the Pulley on the Cable Assembly to the Hook at the rear of the Base Frame Assembly by loosening the Phillips Bolt until the Hook on the Pulley can be attached to the Hook at the Rear of the Base Frame. Tighten the Phillips Bolt to keep the Pulley from coming off of the Hook.
 - 5.** Run the Cable up to the Crossbar and hook the last Pulley to a hook point on the Crossbar.
- c.** Repeat Steps **a** and **b** for the left side.
 - d.** Go back and make sure the path of the Cable appears like the photo and the Cable is not pinched at any point.
 - e. IMPORTANT:** Now, go back and tighten all Bolts on the upright frame that have only been hand tightened in previous assembly steps. The Bolts are shown with a (●) in the image above.

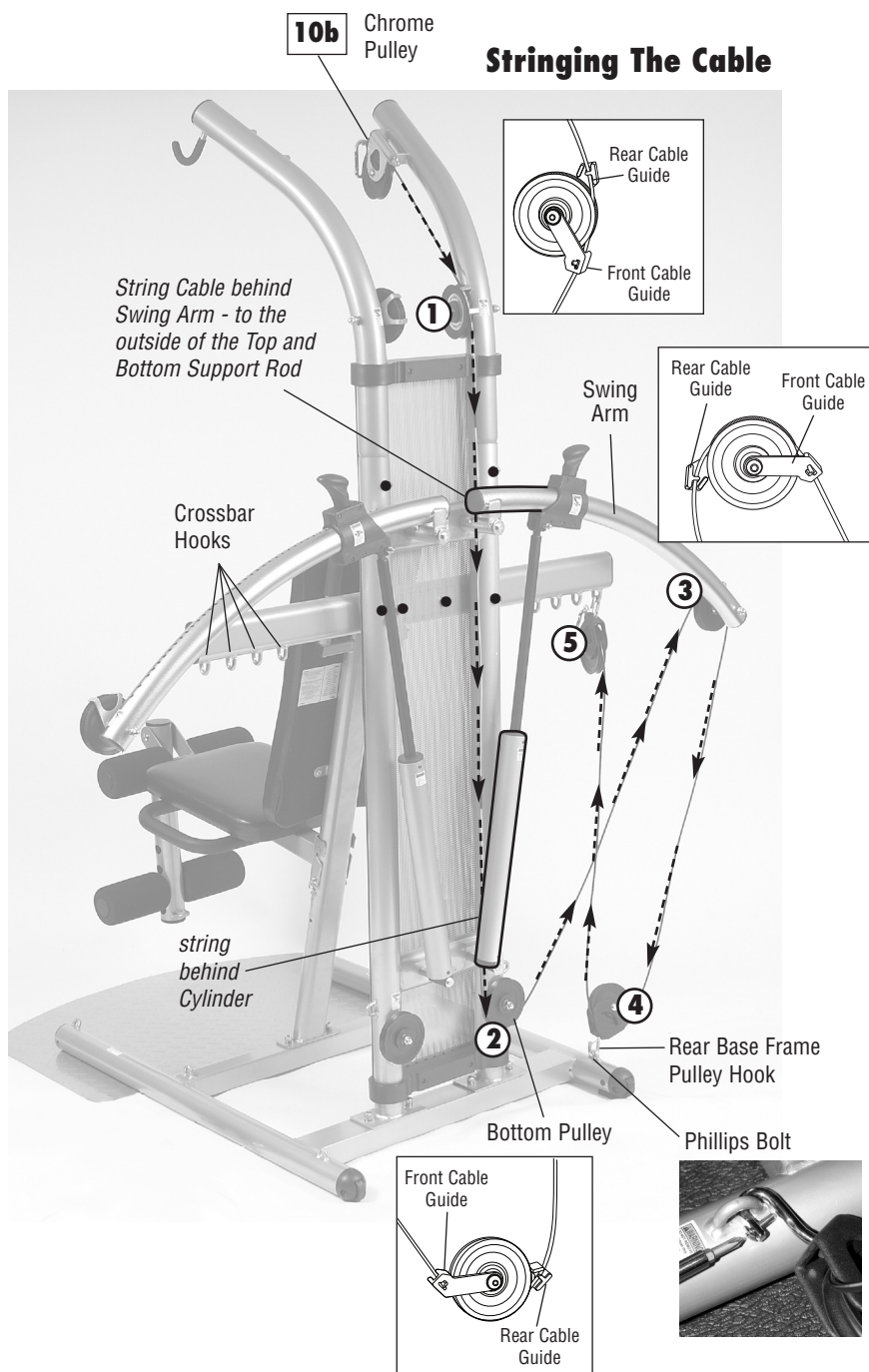

72 SINGLE ARM SEATED FRONT RAISE

START: Sit facing away. Grip one handle with arm at side, thumb facing in.

MOTION: Raise arm in front of body. Pause at top of motion. Lower arm to starting position.

TIPS: Raise arm to shoulder level or slightly higher. Keep elbow almost straight. Do not let wrist bend while lifting. Maintain upright posture in seated position. Contract abdominals to stabilize torso. Perform on both sides.

MUSCLE GROUPS EXERCISED: Anterior deltoids

LEVEL OF DIFFICULTY: Intermediate/Advanced

SEAT: On/Top Position

LEG LIFT: On

ACCESSORIES: Handles

MOVABLE PULLEY POSITIONS

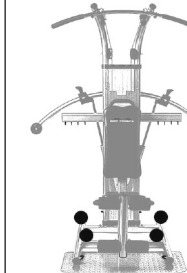

73 SEATED LATERAL RAISE

START: Sit facing away. Grip handles with arms at sides, thumbs facing forward.

MOTION: Raise arms laterally. Pause at top of motion. Lower arms to starting position.

TIPS: Raise arms to shoulder level or slightly higher. Keep elbows almost straight. Do not let wrists bend while lifting. Maintain upright posture in seated position. Contract abdominals to stabilize torso.

MUSCLE GROUPS EXERCISED: Medial deltoids

LEVEL OF DIFFICULTY: Beginner

SEAT: On/Top Position

LEG LIFT: On

ACCESSORIES: Handles

MOVABLE PULLEY POSITIONS

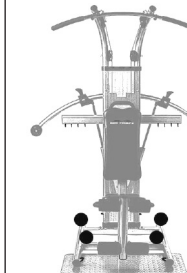

74 SINGLE ARM SEATED LATERAL RAISE

START: Sit facing away. Grip one handle with arm at side, thumb facing forward.

MOTION: Raise arm laterally. Pause at top of motion. Lower arm to starting position.

TIPS: Raise arm to shoulder level or slightly higher. Keep elbow almost straight. Do not let wrist bend while lifting. Maintain upright posture in seated position. Contract abdominals to stabilize torso. Perform on both sides.

MUSCLE GROUPS EXERCISED: Medial deltoids

LEVEL OF DIFFICULTY: Intermediate/Advanced

SEAT: On/Top Position

LEG LIFT: On

ACCESSORIES: Handles

MOVABLE PULLEY POSITIONS

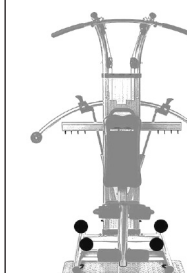

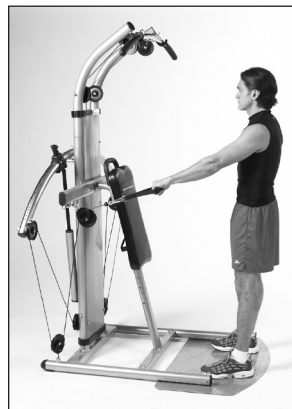

69 SINGLE ARM STANDING REAR DELTOID ROWS

START: Stand facing frame. Feet hip width apart on base. Grip one handle in front of body with palm facing down.

MOTION: Bend elbow and pull up and back. Pause at top of motion. Straighten elbow and return to starting position.

TIPS: Pull elbow slightly behind shoulder line. Keep elbow lifted and bent at a 90 degree angle. Do not lift wrist higher than elbow or shoulder. Contract abdominals to stabilize torso. Perform on both sides.

MUSCLE GROUPS EXERCISED: Posterior deltoids

LEVEL OF DIFFICULTY: Intermediate/Advanced

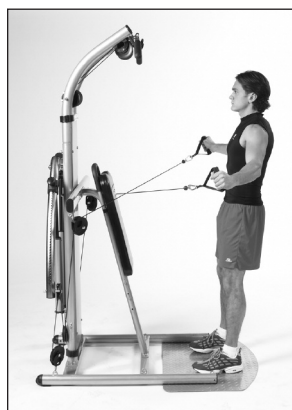
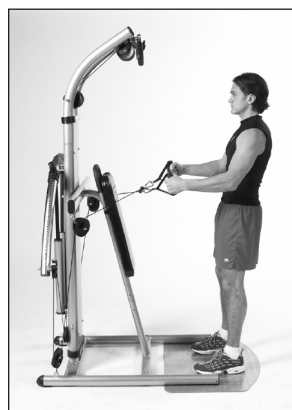

70 REAR CABLE CROSSOVER

START: Stand facing frame. Feet hip width apart on base. Cross cables and grip handles at waist level.

MOTION: Open arms to sides. Pause at end of motion. Close arms and return to starting position.

TIPS: Open arms until elbows are in line with shoulders. Keep arms almost straight throughout motion. Align wrists with elbows. Maintain upright posture throughout exercise. Contract abdominals to stabilize torso.

MUSCLE GROUPS EXERCISED: Posterior deltoids

LEVEL OF DIFFICULTY: Beginner

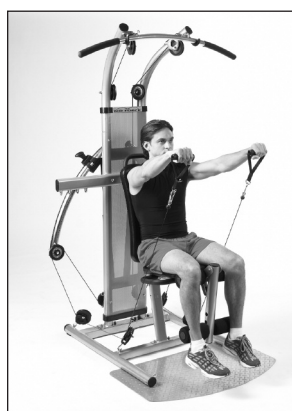
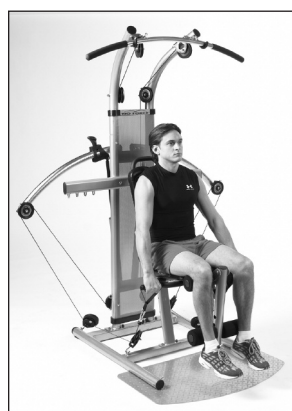

71 SEATED FRONT RAISE

START: Sit facing away. Grip handles with arms at sides, thumbs facing in.

MOTION: Raise arms in front of body. Pause at top of motion. Lower arms to starting position.

TIPS: Raise arms to shoulder level or slightly higher. Keep elbows almost straight. Do not let wrists bend while lifting. Maintain upright posture in seated position. Contract abdominals to stabilize torso.

MUSCLE GROUPS EXERCISED: Anterior deltoids

LEVEL OF DIFFICULTY: Beginner

SEAT: Off

LEG LIFT: Off

ACCESSORIES:
Handles

MOVABLE PULLEY POSITIONS

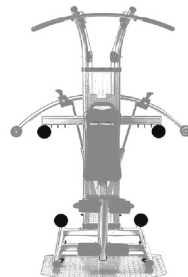

SEAT: Off

LEG LIFT: Off

ACCESSORIES:
Handles

MOVABLE PULLEY POSITIONS

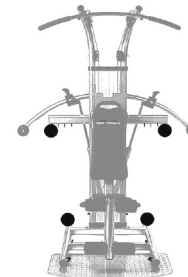

SEAT: On/Top Position

LEG LIFT: On

ACCESSORIES:
Handles

MOVABLE PULLEY POSITIONS

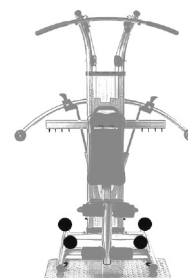

Accessories

- a. Attach the Lat Bar to the Large Clips on the end of the Cables at the Chrome Pulleys on the Top Frame, with the warning label to the front. Then store the Lat Bar in the hooks provided on the Top Frame.
- b. Attach the Handles to the Large Clips on the end of the Cables at the Pulleys on the Crossbar.

Note: You can store the Foot Harnesses on the hook point at the bottom rear of the Leg Lift Tube when the Bio Force® Sport exerciser is not in use.

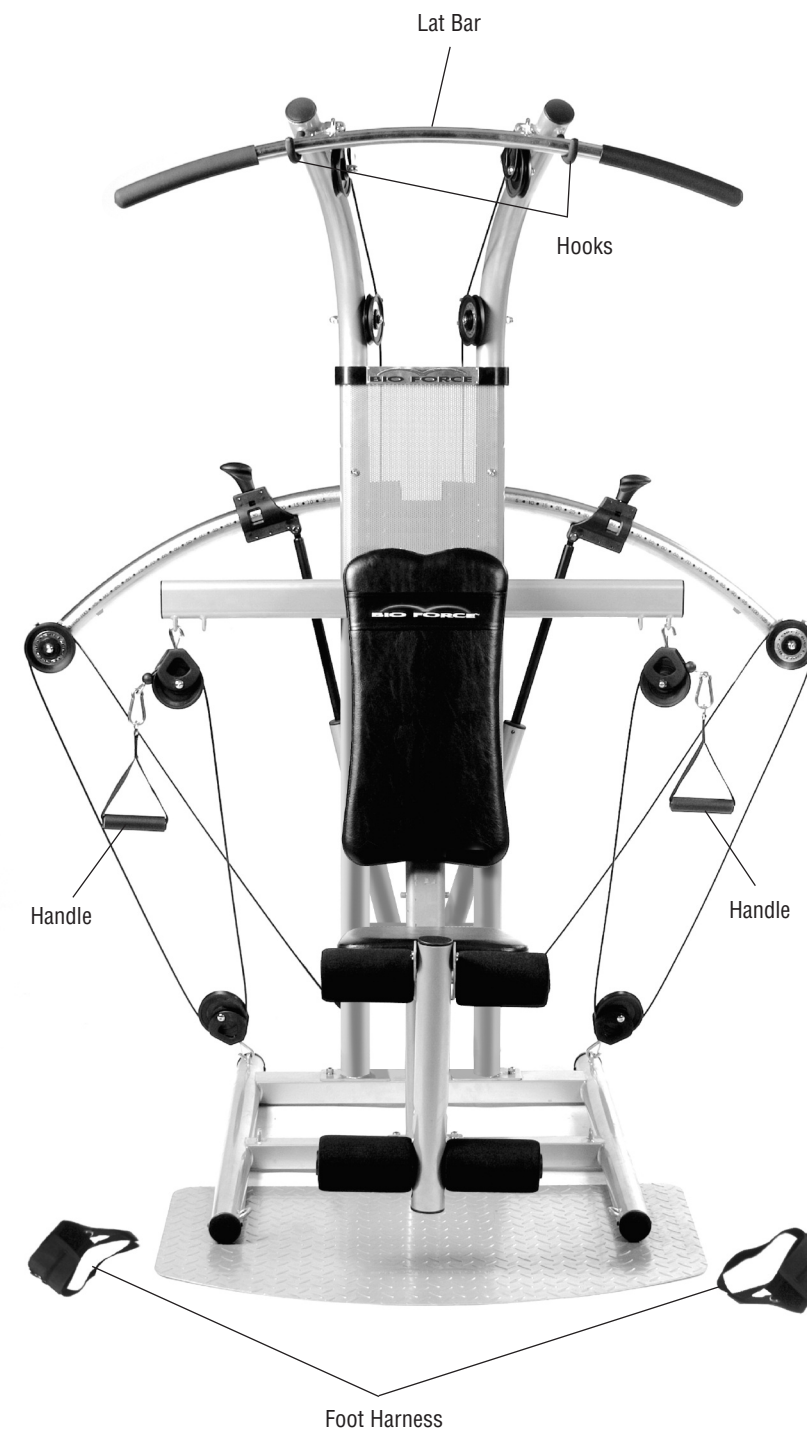

ITEM #	PART #	DESCRIPTION	QTY	ITEM #	PART #	DESCRIPTION	QTY
3	BFSPORT-16	Lower Leg Bar Assembly	1	94	0100174	M10 x 112mm Allen Bolt	2
5	BFSPORT-17	Upper Leg Bar Assembly	1	95	BFPRO-10	M8 x 20mm Allen Bolt	4
6	BFSPORT-15	Removable Leg Tube	1	96	0100176	M10 x 57mm Allen Bolt	2
8	BFSPORT-29	Seat Support Frame	1	98	0100180	Short Hitch Pin w/Lanyard	1
19	BFPRO-16	Padded Pulley Assembly	2	99	0100178	M6 x 10mm Allen Bolt	2
25	0100147	Lat Bar Cap	2	100	0100179	M6 Spring Washer	2
26	0700023	Lat Bar Grip	2	101	0100177	Long Hitch Pin w/Lanyard	1
27	0100148	1" Square Tube Cap	2	102	0100181	M6 Barrel Nut	1
28	BFSPORT-13	Backrest w/Bolts	1	103	0100182	M6 x 20mm Allen Bolt	1
29	BFSPORT-12	Seat w/Bolts	1	104	0100183	13mm & 17mm Hex Wrench	2
30	0100149	Leg Bar Cap	4	105	0100184	8mm Allen Wrench	1
31	0700024	Foam Pad	4	106	0100185	6mm Allen Wrench	1
34	0100151	Plastic Bushing	10	107	0100186	5mm Allen Wrench	1
35	0100152	Bumper	3			w/Phillips Screwdriver	1
36	0100153	Base Plate Pad	9	110	X16472-5	Padded Pulley Assembly w/Bolt	2
38	0600016	Pulley Assembly	2	111	X16472-10	M5 x 16mm Phillips Bolt	2
40L	0100154	Left Plastic Roller Cap	1	114	BFSPORT-18	Cable Assembly	2
40R	0100155	Right Plastic Roller Cap	1	115	BFPRO-19	M10 x 107mm Allen Bolt	6
41	0100156	Roller	2	116	BFPRO-35	Cable Guide A	12
43	0500006	Rear Cover Cap	2	117	BFPRO-36	Small Bushing	10
44	0700025	Foot Harness w/Small Clip	2	118	BFPRO-37	Large Bushing	2
45	BFSPORT-21	Handle Assembly	2	120	0100188	Seat End Cap	4
49L	0700026	Left Adjuster Assembly	1	121	0100189	Stopper	2
49R	0700027	Right Adjuster Assembly	1	124	BFSPORT-20	Lat Bar Assembly	1
55	0700028	Hook Grip	2	126	BFSPORT-02	Base Plate w/Pads	1
56	0500005	Front Top Cover Cap w/ Logo	1	127	0600014	Chrome Pulley Assembly	2
59	0100158	M8 x 110mm Shoulder Bolt	2	129	BFSPORT-10	Perforated Cover	1
60	0100014	M10 Acorn Nut	12	130	BFSPORT-01	Base Frame Assembly	1
63	0600012	Pulley w/Logo Assembly	4	131	BFSPORT-14	Leg Lift Tube Assembly	1
65	0100160	M6 x 30mm Phillips Bolt	6	132	BFSPORT-09	Backrest Support Frame w/Caps	1
66	0100161	ST4.2 x 19mm Phillips Screw	10	133L	BFSPORT-04	Left Top Frame Assembly	1
73	0100005	M8 Acorn Nut	5	133R	BFSPORT-05	Right Top Frame Assembly	1
76	0100162	M8 x 49mm Hex Bolt	2	134	0100146A	End Cap	2
77	0600013	Resistance Cylinder	2	135	0100150A	Round Tube Cap	6
79	0100164	M8 x 30mm x 2t Washer	2	136	0100157A	Round Tube Cap	4
80	0100165	M8 x 20mm Hex Bolt	4	137	BFSPORT-08	Crossbar w/Caps	1
82	0100166	M8 x 20mm x 2t Washer	2	138L	BFSPORT-06	Left Swing Arm Assembly	1
83	BFPRO-06	Large Clip	4	138R	BFSPORT-07	Right Swing Arm Assembly	1
84	0100168	Small Clip	2	139	BFSPORT-03	Upright Frame	1
85	0100169	M10 x 72mm Allen Bolt	2		0500004	Cover Cap Assembly	1
86	0100170	M10 x 30mm Allen Bolt	6		0800051	Basic Instructional Workout DVD	1
87	0100171	M10 Spring Washer	6		BFPRO-34	Cable Guide Fastener Pack	1
88	0100045	M8 x 45mm Allen Bolt	2		BFSPORT-22	Fastener Pack	1
89	0100004	M8 Nylon Nut	2		BFSPORT-24	Owner's Manual - English	1
92	0100172	M8 x 25mm Allen Bolt	4		BFSPORT-30	Owner's Manual - German	1
93	0100173	M5 x 5mm Phillips Bolt	2				



66 STANDING LATERAL RAISE

START: Stand facing away. Feet hip width apart on base. Grip handles with arms at sides, thumbs facing front.

MOTION: Raise arms laterally. Pause at top of motion. Lower arms to starting position.

TIPS: Raise arms to shoulder level or slightly higher. Keep elbows almost straight. Maintain upright posture throughout exercise. Do not lean or tilt backward. Keep wrists straight while raising arms. Contract abdominals to stabilize torso.

MUSCLE GROUPS EXERCISED: Medial deltoids

LEVEL OF DIFFICULTY: Beginner

SEAT: Off

LEG LIFT: Off

ACCESSORIES: Handles

MOVABLE PULLEY POSITIONS

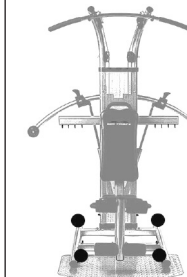

67 SINGLE ARM STANDING LATERAL RAISE

START: Stand facing away. Feet hip width apart on base. Grip one handle with arm at side, thumb facing front.

MOTION: Raise arm laterally. Pause at top of motion. Lower arm to starting position.

TIPS: Raise arm to shoulder level or slightly higher. Keep elbow almost straight. Maintain upright posture throughout exercise. Do not lean or tilt backward. Keep wrist straight while raising arm. Contract abdominals to stabilize torso. Perform on both sides.

MUSCLE GROUPS EXERCISED: Medial deltoids

LEVEL OF DIFFICULTY: Intermediate/Advanced

SEAT: Off

LEG LIFT: Off

ACCESSORIES: Handles

MOVABLE PULLEY POSITIONS

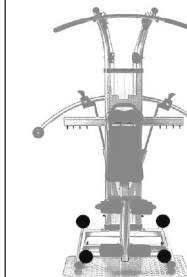

68 STANDING REAR DELTOID ROWS

START: Stand facing frame. Feet hip width apart on base. Grip handles in front of body with palms facing down.

MOTION: Bend elbows and pull up and back. Pause at top of motion. Straighten elbows and return to starting position.

TIPS: Pull elbows slightly behind shoulder line. Keep elbows lifted and bent at a 90 degree angle. Do not lift wrists higher than elbows or shoulders. Contract abdominals to stabilize torso.

MUSCLE GROUPS EXERCISED: Posterior deltoids

LEVEL OF DIFFICULTY: Beginner

SEAT: Off

LEG LIFT: Off

ACCESSORIES: Handles

MOVABLE PULLEY POSITIONS

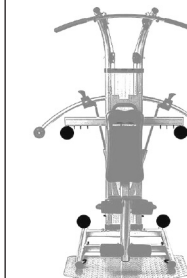



63 UPRIGHT ROW

START: Stand facing frame. Feet hip width apart on base. Grip lat bar in front of thighs with thumbs facing in.

MOTION: Bend elbows and pull bar up to chest level. Pause at top of motion. Lower bar to starting position.

TIPS: Maintain upright posture throughout exercise. Do not lean back while lifting bar. Lift elbows to shoulder height or slightly higher. Keep wrists straight. Contract abdominals to stabilize torso.

SEAT: Off
LEG LIFT: Off
ACCESSORIES: Lat Bar/Front Position

MOVABLE PULLEY POSITIONS

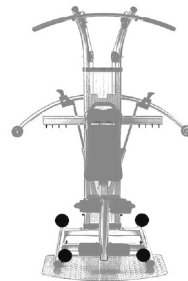

MUSCLE GROUPS EXERCISED: Trapezius, deltoids

LEVEL OF DIFFICULTY: Intermediate/Advanced



64 STANDING FRONT RAISE

START: Stand facing away. Feet hip width apart on base. Grip handles with arms at sides, thumbs facing in.

MOTION: Raise arms in front of body. Pause at top of motion. Lower arms to starting position.

TIPS: Raise arms to nose level. Keep elbows almost straight. Maintain upright posture throughout exercise. Do not lean or tilt backward. Keep wrists straight while raising arms. Contract abdominals to stabilize torso.

SEAT: Off
LEG LIFT: Off
ACCESSORIES: Handles

MOVABLE PULLEY POSITIONS

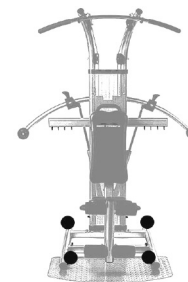

MUSCLE GROUPS EXERCISED: Anterior deltoids

LEVEL OF DIFFICULTY: Beginner



65 SINGLE ARM STANDING FRONT RAISE

START: Stand facing away. Feet hip width apart on base. Grip one handle with arm at side, thumb facing in.

MOTION: Raise arm in front of body. Pause at top of motion. Lower arm to starting position.

TIPS: Raise arm to nose level. Keep elbow almost straight. Maintain upright posture throughout exercise. Do not lean or tilt backward. Keep wrist straight while raising arm. Contract abdominals to stabilize torso. Perform on both sides.

SEAT: Off
LEG LIFT: Off
ACCESSORIES: Handles

MOVABLE PULLEY POSITIONS

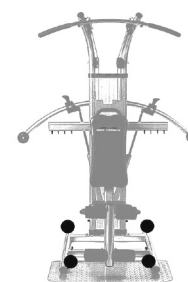

MUSCLE GROUPS EXERCISED: Anterior deltoids

LEVEL OF DIFFICULTY: Intermediate/Advanced

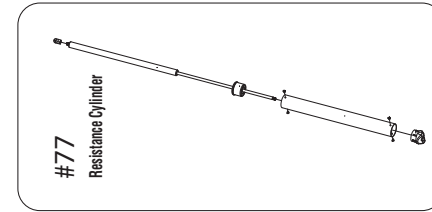

#77 Resistance Cylinder

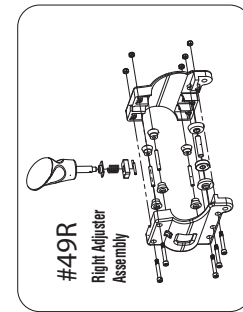

#49R Right Adjuster Assembly

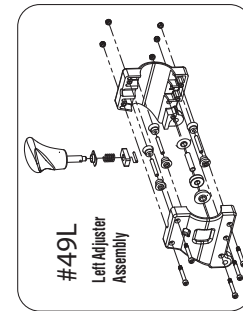

#49L Left Adjuster Assembly

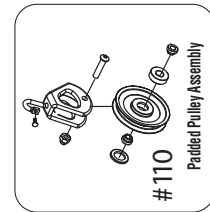

#110 Padded Pulley Assembly

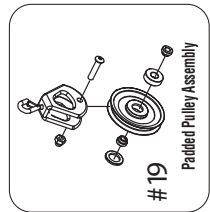

#19 Padded Pulley Assembly

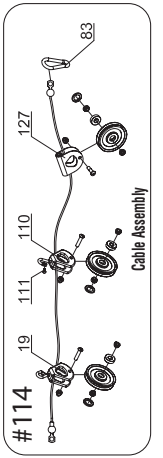

#114 Cable Assembly

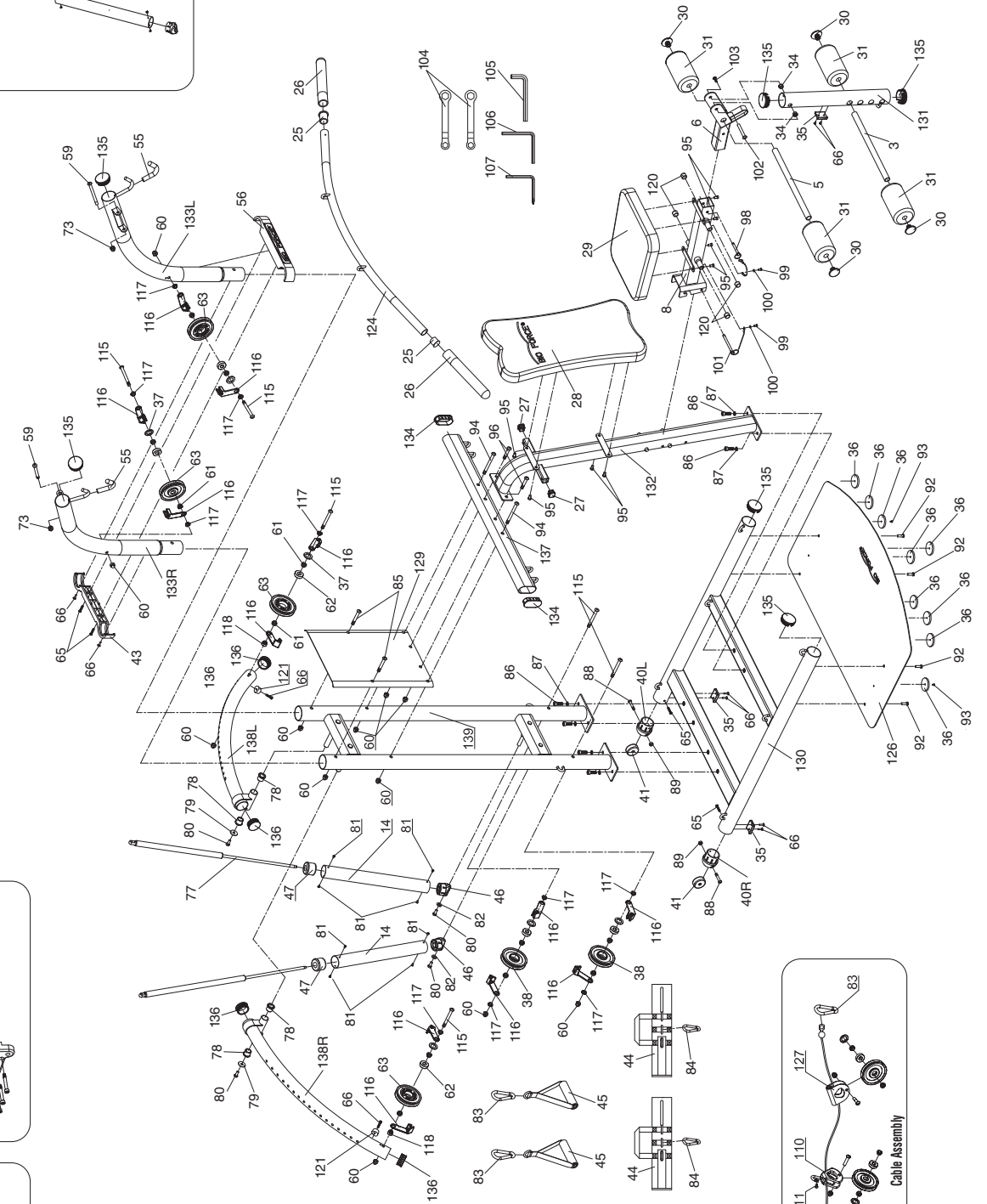

- **Once your equipment is assembled, make sure it is on a solid, level surface with plenty of clearance behind and in front of your equipment.**
- Store your equipment in an area away from children and high traffic areas.
- Wipe your equipment down with a soft, damp cloth frequently to prevent accumulation of sweat and dirt.
- We recommend white lithium grease if lubrication is needed.
- Regularly check the following parts for signs of fraying or other wear: the Handles, Ankle Cuffs, Cables, Pulleys, Large and Small Clips and Frame. If a part needs to be replaced, do not use the equipment until it is repaired.
- Make sure the Clips and Hitch Pins are securely in place.
- Check that the Cables are traveling correctly in the groove of each Pulley.
- Make sure Chrome Pulleys pivot easily.
- Check that Leg Bar Caps are securely in Leg Bar Tubes
- Lat Bar should always be kept in the hooks at the top of the equipment.
- Periodically check bolts to be sure they are all tight.

To move for storage:

We recommend you use 2 people when moving the equipment.

Make sure nothing is in your way before moving exerciser.

Grab frame securely from behind the Bio Force® Sport exerciser, place your foot on the rear cross member (as shown in figure 1), tilt back until wheels engage, roll across the floor to your desired location (figure 2).

Slowly let the front of the Bio Force® Sport exerciser down by holding the top of the Frame and placing your foot against the rear cross member until the Frame Plate is on the floor.



figure 1

CAUTION
When transporting for storage we recommend two people move this unit.



We recommend you use 2 people when moving the equipment.

figure 2

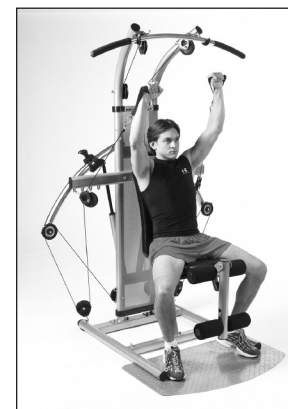
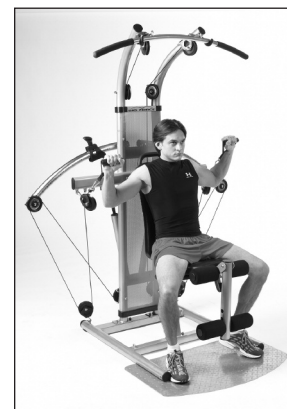

60 SEATED SHOULDER PRESS

START: Sit facing away. Grip handles with thumbs facing in. Elbows bent 90 degrees at shoulder level.

MOTION: Extend elbows and press arms overhead. Pause at top of motion. Bend elbows back to starting position.

TIPS: Press arms up in arcing motion until hands almost touch. Keep elbows and wrists in line with shoulders. Do not lower elbows below shoulder line. Maintain straight wrists. Contract abdominals to stabilize torso.

MUSCLE GROUPS EXERCISED: Deltoids

LEVEL OF DIFFICULTY: Beginner

SEAT: On/Top Position

LEG LIFT: On

ACCESSORIES: Handles

MOVABLE PULLEY POSITIONS

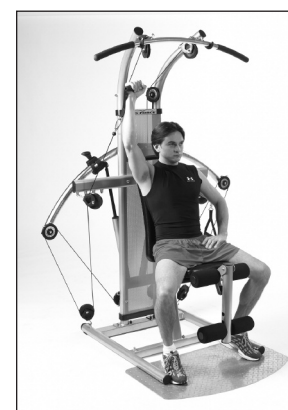
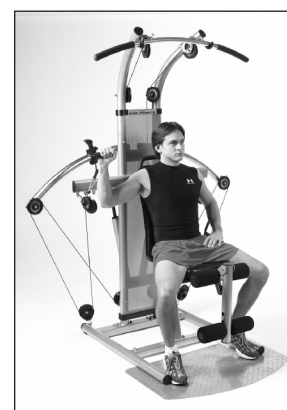
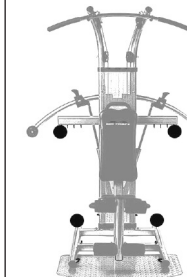

61 SINGLE ARM SHOULDER PRESS

START: Sit facing away. Grip one handle with thumb facing in. Elbow bent 90 degrees at shoulder level.

MOTION: Extend elbow and press arm overhead. Pause at top of motion. Bend elbow back to starting position.

TIPS: Press arm up in arcing motion to midline over head. Keep elbow and wrist in line with shoulder. Do not lower elbow below shoulder line. Maintain straight wrist. Contract abdominals to stabilize torso. Perform on both sides.

MUSCLE GROUPS EXERCISED: Deltoids

LEVEL OF DIFFICULTY: Intermediate/Advanced

SEAT: On/Top Position

LEG LIFT: On

ACCESSORIES: Handles

MOVABLE PULLEY POSITIONS

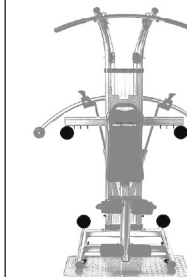

62 SHOULDER SHRUGS

START: Stand facing frame. Feet hip width apart on base. Grip lat bar in front of thighs with thumbs facing in.

MOTION: Shrug shoulders up with straight arms. Pause at top of motion. Lower shoulders to starting position.

TIPS: Maintain upright posture throughout exercise. Contract triceps muscles to stabilize arm. Do not bend elbows while shrugging. Contract abdominals to stabilize torso.

MUSCLE GROUPS EXERCISED: Trapezius

LEVEL OF DIFFICULTY: Beginner

SEAT: Off

LEG LIFT: Off

ACCESSORIES: Lat Bar/Front Position

MOVABLE PULLEY POSITIONS

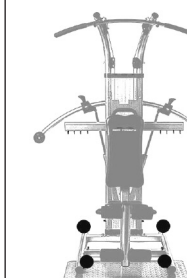



59 STANDING STRAIGHT ARM PULL DOWN

START: Stand facing frame. Feet hip width apart on base. Grip lat bar in wide grip with palms facing down.

MOTION: Pull arms straight down toward hips. Pause at end of motion. Raise arms back to starting position.

TIPS: Keep arms straight throughout exercise. Do not bend elbows while pulling down. Maintain upright posture. Do not lean forward or back. Contract abdominals to stabilize torso.

SEAT: Off

LEG LIFT: Off

ACCESSORIES:
Lat Bar/Lat Tower
Position

MOVABLE PULLEY POSITIONS

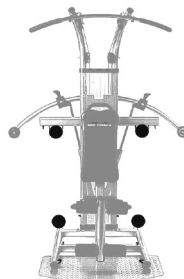

MUSCLE GROUPS EXERCISED: Latissimus, posterior deltoid

LEVEL OF DIFFICULTY: Intermediate

IMPORTANT

Please review this section before you begin exercising.

IMPORTANT:

If you are over 35 and have been inactive for several years, you should consult your physician, who may or may not recommend a graded exercise test. Your physician can also assist you in determining the Target Heart Rate Zone appropriate for your age and physical condition.

You should also consult your physician if you have the following:

- High blood pressure
- High cholesterol
- Asthma
- Heart trouble
- Family history of early stroke or heart attack deaths
- Frequent dizzy spells
- Extreme breathlessness after mild exertion
- Arthritis or other bone problems
- Severe muscular, ligament or tendon problems
- Other known or suspected disease
- If you experience any pain or tightness in your chest, an irregular heartbeat or shortness of breath, stop exercising immediately. Consult your physician before continuing.
- Pregnant
- Balance impairment
- Taking medications that affect heart rate

Workout Phases

Regardless of whether you are working out with your Bio Force® Sport exerciser or doing a cardio workout, your workout should consist of the following three phases.

Warm-Up

To prevent injury and maximize performance, we recommend that each workout period should start with a warm-up. Your warm-up should gently prepare your muscles for the coming exertion. Start by doing 5 to 10 minutes of gentle exercise (such as walking) that gradually increases your heart rate and loosens up your muscles. Your warm-up exercise should be aerobic in nature and only require an easy, unforced range of motion. This should be followed by 5 to 10 minutes of stretching. Refer to the stretches found on pages 40 and 41 of this manual. Never push yourself beyond a point of gentle tension or strain. Keep your movements gentle, rhythmic and controlled.

Muscle Toning or Cardio Workout

Your warm-up should be followed by either a workout with the Bio Force® Sport exerciser or a cardio workout, depending on which workout you are doing. Regardless of which workout you are doing, build up as your current fitness level allows and progress at a rate that is comfortable to you.

For the first week or so, you may feel some muscle soreness. This is quite normal and will disappear in a matter of days. If you experience major discomfort, you may be on a regimen that is too advanced for you or you may have increased your program too rapidly.

Cool Down and Stretching

Your workout should be followed by a cool down. The cool down should consist of 5 to 10 minutes of gentle exercise, followed by stretching. Refer to the stretches found on pages 40 and 41 of this manual. Never push yourself beyond a point of gentle tension or strain. Keep your movements gentle, rhythmic and controlled.

When to Exercise

The hour just before the evening meal is a popular time for exercise. The late afternoon workout provides a welcome change of pace at the end of the work day and helps dissolve the day's worries and tensions.

Another popular time to work out is early morning, before the work day begins. Advocates of the early start say it makes them more alert and energetic on the job.

Among the factors you should consider in developing your workout schedule are personal preference, job and family responsibilities, availability of exercise facilities and weather. It's important to schedule your workouts for a time when there is little chance that you will have to cancel or interrupt them because of other demands on your time.

You should not exercise strenuously during extremely hot, humid weather or within two hours after eating. Heat and/or digestion both make heavy demands on the circulatory system, and in combination with exercise can be an over-taxing double load.

Measuring Your Heart Rate

When checking Heart Rate during a workout, take your pulse within five seconds after interrupting exercise because it starts to go down once you stop moving. Count pulse for 10 seconds and multiply by six to get the per-minute rate.

Target Heart Rate

Aerobic intensity guidelines for healthy adults are generally set at 60 to 85 percent of heart rate. But, if you're out of shape, remember that moderate to low level and consistent cardiovascular training – well below the standard recommendations set forth – can result in substantial and beneficial effects to your health and can greatly improve cardiovascular endurance.

You can use the following calculation to determine what percentage of your heart rate you are working at:

$$\% \text{ heart rate} = (220 - \text{age}) \times \%$$

Using this calculation, a 70% heart rate for a 40 year old would be $(220 - 40) \times 70\%$ or 126. Thus, this individual would need to reach 126 beats per minute to equal a 70% heart rate.

The above recommendations are guidelines. People with any medical limitations should discuss this formula with their physician.

Clothing

All exercise clothing should be loose-fitting to permit freedom of movement, and should make the wearer feel comfortable and self-assured.

Never wear rubberized or plastic clothing, garments like this can interfere with the evaporation of perspiration and can cause body temperature to rise to dangerous levels.

Wear comfortable, supportive athletic shoes with non-slip soles, such as running or aerobic shoes.

Tips to Keep You Going

1. Adopt a specific plan and write it down.
2. Keep setting realistic goals as you go along, and remind yourself of them often.
3. Keep a log to record your progress and make sure to keep it up-to-date. See charts in this booklet.
4. Include weight and/or percent body fat measures in your log. Extra pounds can easily creep back.
5. Enlist the support and company of your family and friends.
6. Update others on your successes.
7. Avoid injuries by pacing yourself and including a warm up and cool down period as part of every workout.
8. Reward yourself periodically for a job well done!



56 SINGLE ARM STANDING ROW - OVERHAND POSITION

START: Stand facing frame. Rest legs against pads. Bend knees slightly. Grip one handle with thumb facing inward.

MOTION: Bend elbow and pull handle toward waist. Pause at end of motion. Extend elbow and return to starting position.

TIPS: Keep elbow close to side while pulling. Maintain upright posture. Do not lean forward or back. Keep shoulders level. Do not rotate side while pulling. Contract abdominals to stabilize back. Perform on both sides.

MUSCLE GROUPS EXERCISED: Latissimus, biceps, posterior deltoids

LEVEL OF DIFFICULTY: Intermediate/Advanced

SEAT: On/Bottom Position

LEG LIFT: On

ACCESSORIES: Handles

MOVABLE PULLEY POSITIONS

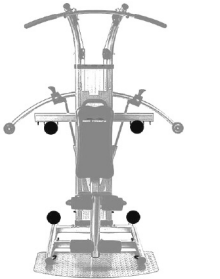

57 STANDING ROW - UNDERHAND POSITION

START: Stand facing frame. Rest legs against pads. Bend knees slightly. Grip handles with thumbs facing outward.

MOTION: Bend elbows and pull handles toward waist. Pause at end of motion. Extend elbows and return to starting position.

TIPS: Keep elbows close to sides while pulling. Squeeze shoulder blades together. Maintain upright posture. Do not lean forward or back. Contract abdominals to stabilize back.

MUSCLE GROUPS EXERCISED: Latissimus, biceps, posterior deltoids

LEVEL OF DIFFICULTY: Beginner

SEAT: On/Bottom Position

LEG LIFT: On

ACCESSORIES: Handles

MOVABLE PULLEY POSITIONS

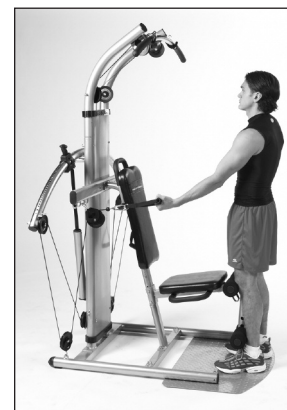
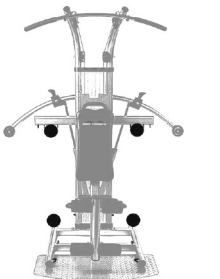

58 SINGLE ARM STANDING ROW - UNDERHAND POSITION

START: Stand facing frame. Rest legs against pads. Bend knees slightly. Grip one handle with thumb facing outward.

MOTION: Bend elbow and pull handle toward waist. Pause at end of motion. Extend elbow and return to starting position.

TIPS: Keep elbow close to side while pulling. Maintain upright posture. Do not lean forward or back. Keep shoulders level. Do not rotate side while pulling. Contract abdominals to stabilize back. Perform on both sides.

MUSCLE GROUPS EXERCISED: Latissimus, biceps, posterior deltoids

LEVEL OF DIFFICULTY: Intermediate/Advanced

SEAT: On/Bottom Position

LEG LIFT: On

ACCESSORIES: Handles

MOVABLE PULLEY POSITIONS

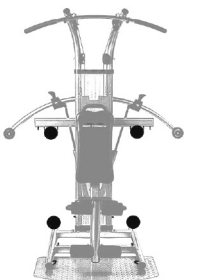



53 STANDING ROW - NEUTRAL POSITION

START: Stand facing frame. Rest legs against pads. Bend knees slightly. Grip handles with thumbs facing up.

MOTION: Bend elbows and pull handles toward waist. Pause at end of motion. Extend elbows and return to starting position.

TIPS: Keep elbows close to sides while pulling. Squeeze shoulder blades together. Maintain upright posture. Do not lean forward or back. Contract abdominals to stabilize back.

MUSCLE GROUPS EXERCISED: Latissimus, biceps, posterior deltoids

LEVEL OF DIFFICULTY: Beginner

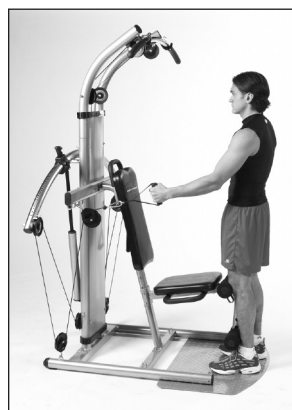

54 SINGLE ARM STANDING ROW - NEUTRAL POSITION

START: Stand facing frame. Rest legs against pads. Bend knees slightly. Grip one handle with thumb facing up.

MOTION: Bend elbow and pull handle toward waist. Pause at end of motion. Extend elbow and return to starting position.

TIPS: Keep elbow close to side while pulling. Maintain upright posture. Do not lean forward or back. Keep shoulders level. Do not rotate side while pulling. Contract abdominals to stabilize back. Perform on both sides.

MUSCLE GROUPS EXERCISED: Latissimus, biceps, posterior deltoids

LEVEL OF DIFFICULTY: Intermediate/Advanced

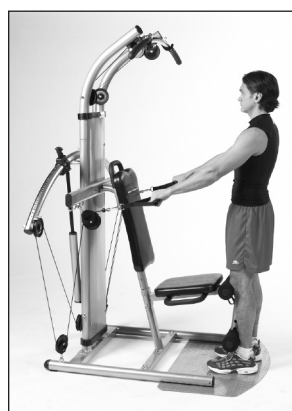

55 STANDING ROW - OVERHAND POSITION

START: Stand facing frame. Rest legs against pads. Bend knees slightly. Grip handles with thumbs facing inward.

MOTION: Bend elbows and pull handles toward waist. Pause at end of motion. Extend elbows and return to starting position.

TIPS: Keep elbows close to sides while pulling. Squeeze shoulder blades together. Maintain upright posture. Do not lean forward or back. Contract abdominals to stabilize back.

MUSCLE GROUPS EXERCISED: Latissimus, biceps, posterior deltoids

LEVEL OF DIFFICULTY: Beginner

SEAT: On/Bottom Position

LEG LIFT: On

ACCESSORIES: Handles

MOVABLE PULLEY POSITIONS

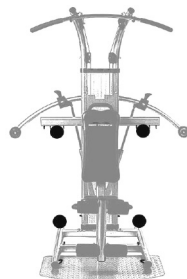

SEAT: On/Bottom Position

LEG LIFT: On

ACCESSORIES: Handles

MOVABLE PULLEY POSITIONS

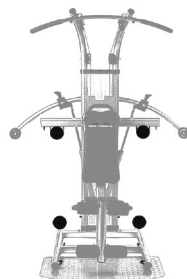

SEAT: On/Bottom Position

LEG LIFT: On

ACCESSORIES: Handles

MOVABLE PULLEY POSITIONS

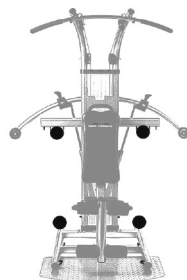

The Bio Force® Sport exerciser is more than just a strength training machine; it is a total body exercise and nutrition system. It is a “fitness for life” plan that goes hand in hand with an overall healthy lifestyle. This includes regular check-ups, healthy eating habits and exercise for the rest of your life.

Today, all fitness research recommends both cardiovascular exercise and strength conditioning to achieve balanced fitness. By improving your cardiovascular fitness you will strengthen your heart and lungs, increase your stamina and endurance, and help with weight loss. Strength conditioning adds lean muscle to your body, which increases your body’s metabolism. And we all know that a healthy eating plan is an important part of any balanced fitness program.

The Bio Force® Sport System is designed to help you achieve a balanced fitness program. The system consists of three parts:

1. Strength Conditioning. The Bio Force® Sport exerciser was designed to help you strengthen your upper and lower body. We recommend that you work out for at least 30 minutes, 3 times a week. However, the frequency and duration of your workouts will depend on your current fitness level and goals.

2. Cardiovascular Exercise. The Bio Force® Sport system includes a cardio workout program. You can achieve an effective cardio workout from a variety of activities, such as walking, hiking, swimming and jogging. We recommend that you do a cardio workout for at least 30 minutes, 3 times a week. You can easily alternate days for your Bio Force® and cardio workouts. Again, the frequency and duration of your workouts will depend on your current fitness level and goals. Please refer to the Cardiovascular Workout section on pages 83 and 85 to determine the workout that is appropriate for you.

3. Nutrition. The Bio Force® Sport system also includes the Eating Plan booklet to provide you with healthy eating choices.

For best results, we recommend that you begin with Eric Lichter’s 8 Week Body Transformation Plan on pages 30-39 of this manual.

IMPORTANT EXERCISE AND SAFETY TIPS

1. Review this Owner’s Manual/Exercise Book and the video completely before you begin your exercise program. Remember to follow the instructions exactly – they have been developed with your health and safety in mind.
2. Perform the exercises at a slow and controlled speed. For best results, perform all of the exercises at the tempo demonstrated in the video. Working at a fast pace is not recommended, and may compromise your safety and results.
3. You may not be able to complete all of the sets and repetitions suggested at first. When you feel your muscles fatiguing, or are unable to work with good form and technique, decrease your resistance level or take a short break and rest.

4. Keep track of how many sets and repetitions of each exercise you are able to do at first. You will be surprised at how quickly you progress. In just a few weeks you’ll probably be able to complete all of the sets and repetitions at the resistance level you choose.
5. Progress slowly. If you are very sore and tired after your workout, you are working at a level that is too hard. Great results can be obtained by working at a level that challenges you, but doesn’t create soreness and excessive fatigue.
6. It is important that you know how to work out safely and properly. These safety steps are for your benefit and you should follow them closely to maximize the effectiveness of your workout routine.
7. You should begin to feel results within one to two weeks of working out with your equipment. Look for better posture and the feeling of more strength and efficiency in your muscles.

Bio Force® Sport Pulley Positions

The Bio Force® Sport exerciser uses a simple system of Cables, Pulleys and Hooks to perform over 100 body shaping exercises. Below you will find a diagram indicating the possible Moveable Pulley and Accessories Hooks position.

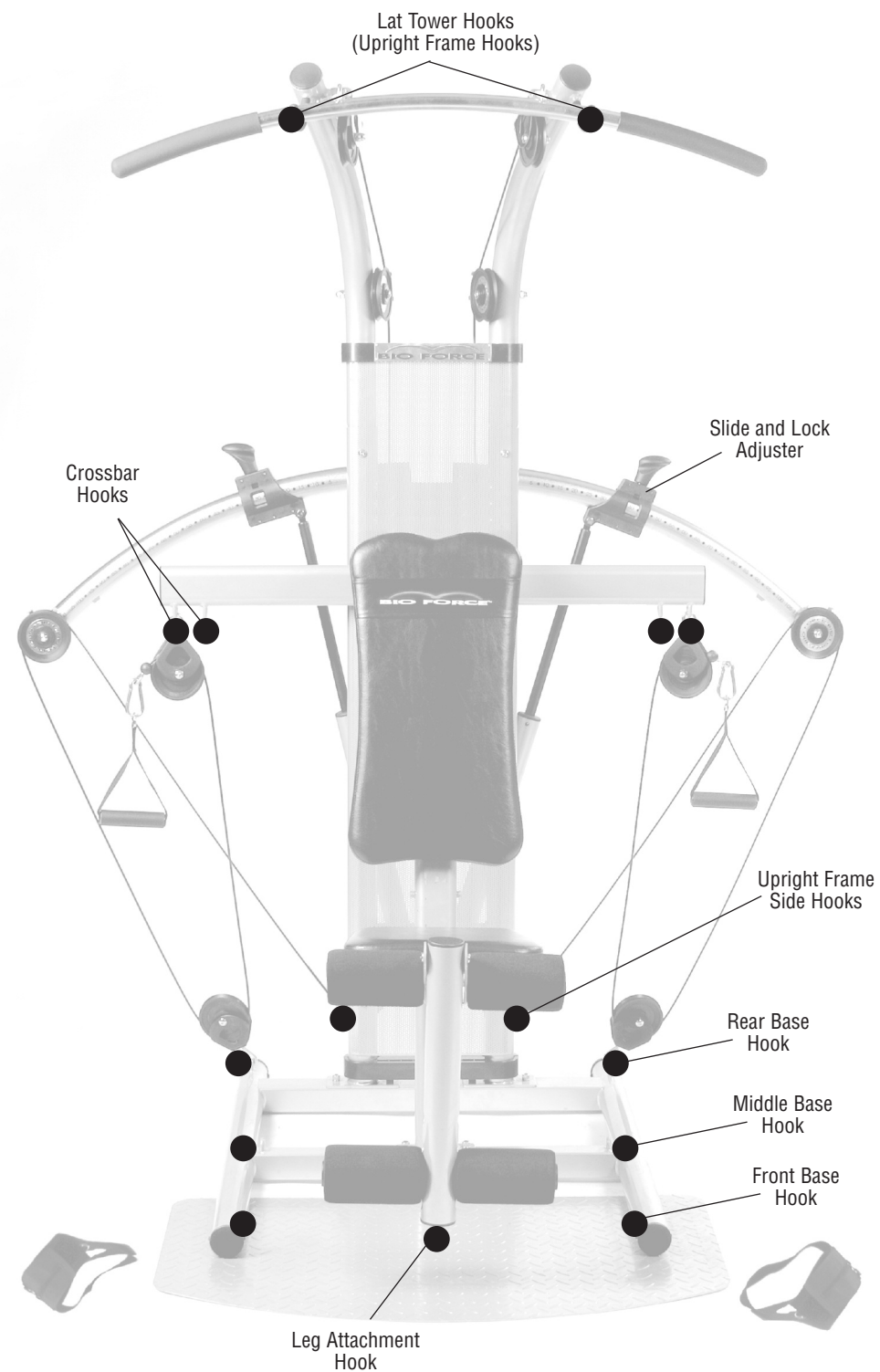

50 SINGLE ARM SEATED PULL OVER

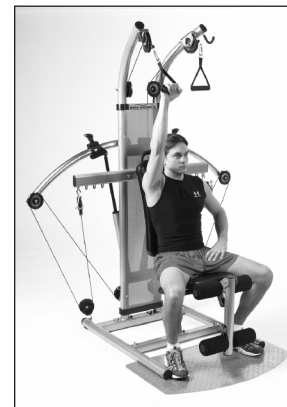

START: Sit facing away. Feet on base. Grip one handle with palm facing forward.

MOTION: Pull arm forward and down until handle is at waist level. Pause at end of motion. Raise arm back to starting position.

TIPS: Keep arm straight throughout exercise. Do not bend elbow while pulling down. Maintain upright posture. Do not tip or rotate torso. Contract abdominals to stabilize torso. Perform on both sides.

MUSCLE GROUPS EXERCISED: Latissimus, posterior deltoid
LEVEL OF DIFFICULTY: Intermediate/Advanced

SEAT: On/Bottom Position

LEG LIFT: On

ACCESSORIES: Handles/Lat Tower

MOVABLE PULLEY POSITIONS

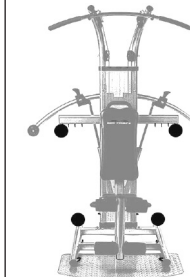

51 STRAIGHT ARM LATERAL PULL DOWN

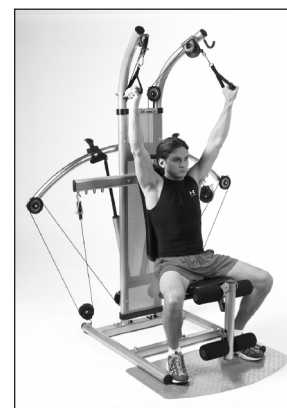

START: Sit facing away. Feet on base. Grip handles with palms facing outward.

MOTION: Pull arms down laterally until handles are at waist level. Pause at end of motion. Raise arms back to starting position.

TIPS: Keep arms straight throughout exercise. Do not bend elbows while pulling down. Maintain upright posture. Do not round lower back. Keep shoulders pulled down away from ears. Contract abdominals to stabilize torso.

MUSCLE GROUPS EXERCISED: Latissimus
LEVEL OF DIFFICULTY: Beginner

SEAT: On/Bottom Position

LEG LIFT: On

ACCESSORIES: Handles/Lat Tower

MOVABLE PULLEY POSITIONS

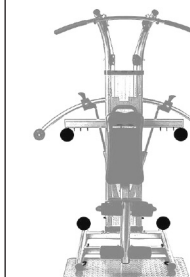

52 SINGLE STRAIGHT ARM LATERAL PULL DOWN

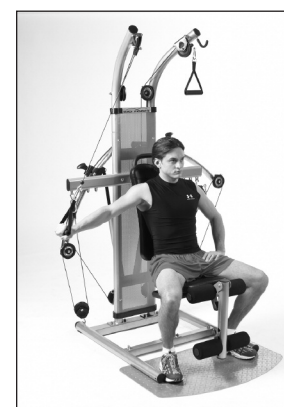
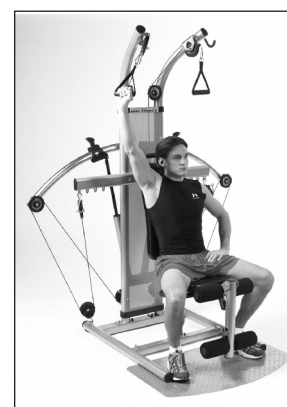

START: Sit facing away. Feet on base. Grip one handle with palm facing outward.

MOTION: Pull arm down laterally until handle is at waist level. Pause at end of motion. Raise arm back to starting position.

TIPS: Keep arm straight throughout exercise. Do not bend elbow while pulling down. Maintain upright posture. Do not tip or rotate torso. Contract abdominals to stabilize torso. Perform on both sides.

MUSCLE GROUPS EXERCISED: Latissimus
LEVEL OF DIFFICULTY: Intermediate/Advanced

SEAT: On/Bottom Position

LEG LIFT: On

ACCESSORIES: Handles/Lat Tower

MOVABLE PULLEY POSITIONS

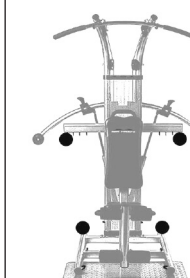



47 NEUTRAL GRIP PULL DOWN

START: Sit facing frame. Lean back slightly. Grip handles in neutral position with palms facing in.

MOTION: Bend elbows and pull handles down to chest. Pause at bottom of motion. Extend elbows and raise to starting position.

TIPS: Hold leaning position throughout exercise. Do not move torso forward and back. Maintain straight spine while leaning. Do not round lower back. Contract abdominals to stabilize torso.

MUSCLE GROUPS EXERCISED: Latissimus, biceps

LEVEL OF DIFFICULTY: Beginner

SEAT: On/Bottom Position

LEG LIFT: On

ACCESSORIES: Handles/Lat Tower

MOVABLE PULLEY POSITIONS

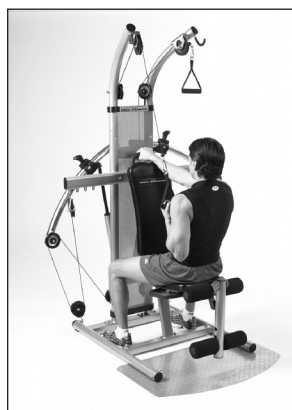
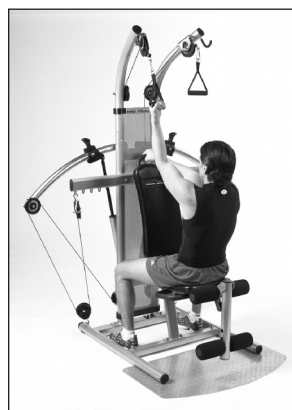
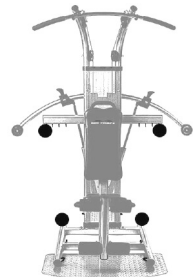

48 SINGLE ARM NEUTRAL GRIP PULL DOWN

START: Sit facing frame. Lean back slightly. Grip one handle in neutral position with palm facing in.

MOTION: Bend elbow and pull handle down to chest. Pause at bottom of motion. Extend elbow and raise to starting position.

TIPS: Hold leaning position throughout exercise. Do not move torso forward or back. Maintain straight spine while leaning. Do not tip or rotate to one side. Contract abdominals to stabilize torso. Perform on both sides.

MUSCLE GROUPS EXERCISED: Latissimus, biceps

LEVEL OF DIFFICULTY: Intermediate/Advanced

SEAT: On/Bottom Position

LEG LIFT: On

ACCESSORIES: Handles/Lat Tower

MOVABLE PULLEY POSITIONS

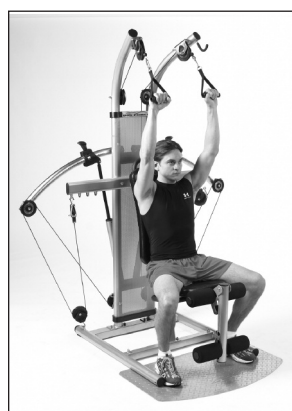
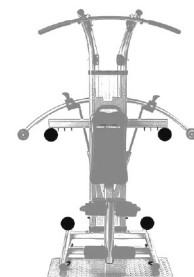

49 SEATED PULL OVER

START: Sit facing away. Feet on base. Grip handles with palms facing forward.

MOTION: Pull arms forward and down until handles are at waist level. Pause at end of motion. Raise arms back to starting position.

TIPS: Keep arms straight throughout exercise. Do not bend elbows while pulling down. Maintain upright posture. Do not round lower back. Keep shoulders pulled down away from ears. Contract abdominals to stabilize torso.

MUSCLE GROUPS EXERCISED: Latissimus, posterior deltoid

LEVEL OF DIFFICULTY: Beginner

SEAT: On/Bottom Position

LEG LIFT: On

ACCESSORIES: Handles/Lat Tower

MOVABLE PULLEY POSITIONS

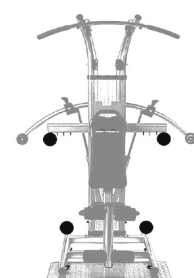

Your Bio Force® Sport exerciser is one serious piece of exercise equipment! We recommend that before you start working out, you read the entire Owner's Manual and view the workout video that came with your equipment.

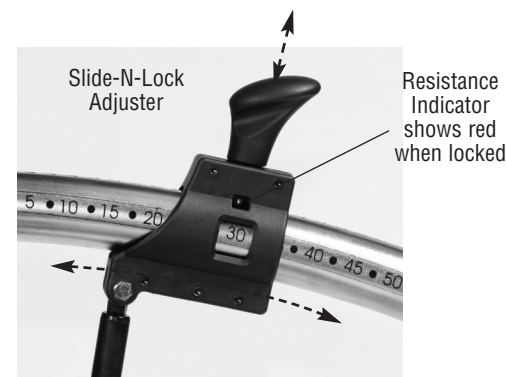

Adjusting Resistance with Slide-N-Lock Technology

To change resistance, it just takes seconds. Simply pull up on the Slide-N-Lock Adjuster to disengage it from its current position. Then, keeping the Adjuster disengaged, simply slide it to the next desired weight position and release it. Make sure the locking mechanism has engaged into the new resistance position. To double-check, the resistance indicator window should show "red."

Adjusting the Seat

The Bio Force® Sport seat has two height positions. If you are taller, you may wish to use the lower position to get the fullest range of motion from the Lat Tower exercises. If you are shorter, you may prefer the higher position to more easily reach the Lat Bar. It is up to you!



If you wish to change positions, simply remove the Long Hitch Pin, and pull up on the Seat to disengage it from the Positioning Pins. Move it to the new position and place the Seat onto the Positioning Pins. Once it is in place, reinsert the Long Hitch Pin to secure. **Do not use the Seat unless the Long Hitch Pin is in place.**

Adjusting the Leg Attachment

The lower Foam Pad on the Leg Lift Tube has 4 positions. These are to accommodate user leg length and comfort.

To change the Foam Pad, simply remove the Leg Bar Cap from one end of the Pad. Slide off the Foam Pad from that side. Now slide the Tube and remaining Pad out of the Leg Assembly hole. Reinsert into the new desired position. Replace the first Foam Pad and replace the Leg Bar Cap. Make certain the Leg Bar Cap is secured.



ERIC LICHTER
Professional Trainer

In just two short months you can be on your way to achieving your fitness dreams. That's right...just two months...eight weeks...60 days.

That is all it takes to follow my body transformation plan. And best of all, when you finish my 8 week program, you'll be hooked. You are going to feel and look better than ever. Friends, relatives and co-workers are going to marvel at the changes in your body. And you know what? You are going to want more!

So what have you got to lose? Step up and take the eight week challenge. I don't care how old you are...I don't care what shape you are in...I don't care if you're an elite athlete or the farthest you walk is from the couch to the fridge. You're going to work...You're going to sweat...And I'm going to make sure you love every minute of it! The results you'll see when you take the eight week challenge are going to blow you away! So get ready to get yourself into the best shape of your life and see what you've been missing!

PLAN INTRODUCTION:

Any fitness plan has three parts: Strength Training, Proper Nutrition and Aerobic Exercise. Each part is essential to success. If you miss anyone of the elements, you will not see the results you are after. My 8 Week Plan contains all three. Take a look at the outlines below. Review each part and make them a part of your life.

GETTING STARTED:

Everyone has to start somewhere...and this is it. Take a photo of yourself today in your swimsuit. Guys - shirts off! Ladies - make it a two piece! Now is the time to make an honest assessment of where you are...and where you want to go. Also, take your measurements. You will find a body measurement guide at the end of this manual. Note that we are not going to concern ourselves too much with body weight. This is because body weight does not always tell the whole story. It is a fact that fat weighs less than muscle, but muscle is leaner and more compact than fat. So...you can be losing inches and getting the lean, sexy body you've always wanted, but not be losing that much weight. That is because you are trading fat for muscle. Therefore, a better indicator is inch loss...Even easier than that is noticing how much better your clothes fit. Okay...so you've taken your picture and your measurements. Store them in a safe place.

In 8 weeks, you are going to be amazed at the difference!

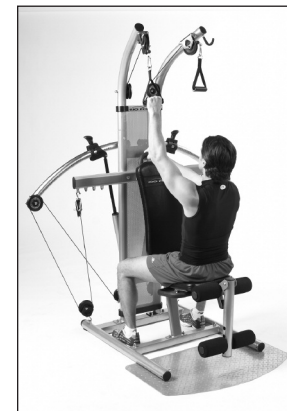

MUSCLE GROUPS EXERCISED: Latissimus, biceps

LEVEL OF DIFFICULTY: Intermediate/Advanced

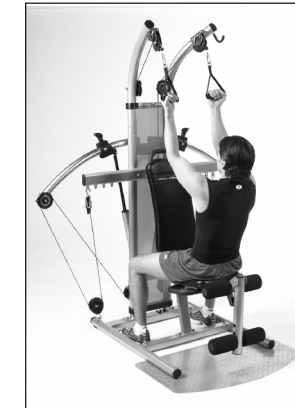

MUSCLE GROUPS EXERCISED: Latissimus, biceps

LEVEL OF DIFFICULTY: Beginner

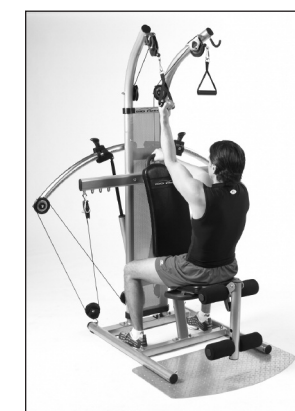

MUSCLE GROUPS EXERCISED: Latissimus, biceps

LEVEL OF DIFFICULTY: Intermediate/Advanced



44 SINGLE ARM OVERHAND PULL DOWN

START: Sit facing frame. Grip one handle with palms facing forward. Lean back slightly.

MOTION: Bend elbow and pull handle down to chest. Pause at bottom of motion. Extend elbow and raise to starting position.

TIPS: Hold leaning position throughout exercise. Do not move torso forward or back. Maintain straight spine while leaning. Do not tip or rotate to one side. Contract abdominals to stabilize torso. Perform on both sides.

45 REVERSE GRIP PULL DOWN

START: Sit facing frame. Lean back slightly. Grip handles in underhand position.

MOTION: Bend elbows and pull handles down to chest. Pause at bottom of motion. Extend elbows and raise to starting position.

TIPS: Hold leaning position throughout exercise. Do not move torso forward and back. Maintain straight spine while leaning. Do not round lower back. Contract abdominals to stabilize torso.

46 SINGLE ARM REVERSE GRIP PULL DOWN

START: Sit facing frame. Lean back slightly. Grip one handle in underhand position.

MOTION: Bend elbow and pull handle down to chest. Pause at bottom of motion. Extend elbow and raise to starting position.

TIPS: Hold leaning position throughout exercise. Do not move torso forward or back. Maintain straight spine while leaning. Do not tip or rotate to one side. Contract abdominals to stabilize torso. Perform on both sides.

SEAT: On/Bottom Position

LEG LIFT: On

ACCESSORIES: Handles/Lat Tower

MOVABLE PULLEY POSITIONS

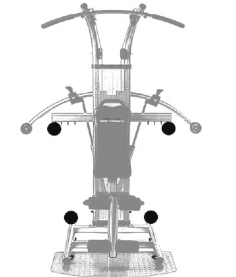

SEAT: On/Bottom Position

LEG LIFT: On

ACCESSORIES: Handles/Lat Tower

MOVABLE PULLEY POSITIONS

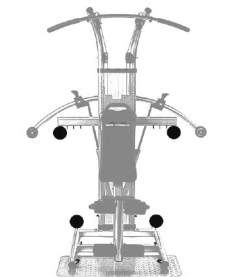

SEAT: On/Bottom Position

LEG LIFT: On

ACCESSORIES: Handles/Lat Tower

MOVABLE PULLEY POSITIONS

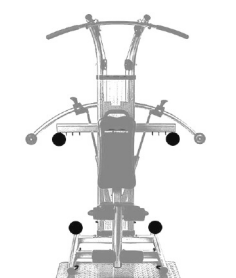



41 CLOSED GRIP CHEST PRESS

START: Sit facing away. Grip handles with palms facing in. Elbows bent 90 degrees at waist level. Cables under arms.

MOTION: Extend elbows and press arms straight forward. Pause at end of motion. Bend elbows back to starting position.

TIPS: Press arms forward in arcing motion. Keep elbows in line with shoulders and wrists straight. Maintain upright posture in seated position. Contract abdominals to stabilize back.

SEAT: On/Top Position

LEG LIFT: On

ACCESSORIES: Handles

MOVABLE PULLEY POSITIONS

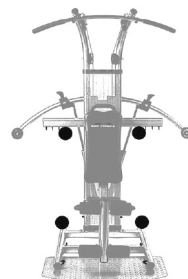

MUSCLE GROUPS EXERCISED: Pectoralis, triceps, anterior deltoids

LEVEL OF DIFFICULTY: Beginner

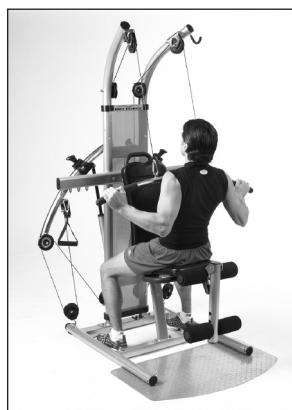

42 LAT BAR PULL DOWN

START: Sit facing frame. Grip lat bar toward outside of handles, palms facing forward. Lean back slightly.

MOTION: Bend elbows and pull bar down to chest. Pause at bottom of motion. Extend elbows and raise to starting position.

TIPS: Hold leaning position throughout exercise. Do not move torso forward and back. Maintain straight spine while leaning back. Do not round lower back. Contract abdominals to stabilize torso.

SEAT: On/Top Position

LEG LIFT: On

ACCESSORIES: Lat Bar/Lat Tower Pos.

MOVABLE PULLEY POSITIONS

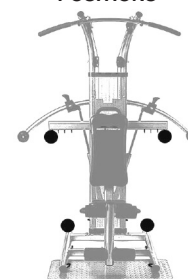

MUSCLE GROUPS EXERCISED: Latissimus, biceps

LEVEL OF DIFFICULTY: Beginner

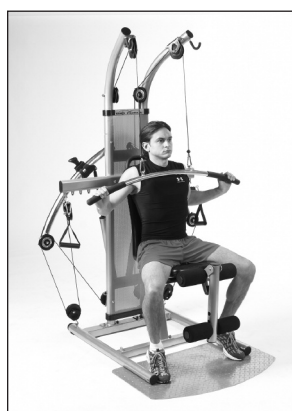

43 LAT BAR FRONT PULL DOWN

START: Sit facing away. Feet on base. Grip lat bar toward outside of handles, palms facing forward.

MOTION: Bend elbows and pull bar down to chest. Pause at bottom of motion. Extend elbows and raise to starting position.

TIPS: Maintain upright posture throughout exercise. Do not round lower back. Keep shoulders pulled down away from ears. Contract abdominals to stabilize torso.

SEAT: On/Top Position

LEG LIFT: On

ACCESSORIES: Lat Bar/Lat Tower Pos.

MOVABLE PULLEY POSITIONS

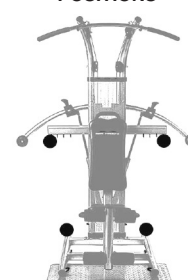

MUSCLE GROUPS EXERCISED: Latissimus, biceps

LEVEL OF DIFFICULTY: Beginner

PART ONE:
STRENGTH TRAINING WITH THE
BIO FORCE® SPORT EXERCISER

The first part of our fitness equation is strength training. The benefits of strength training are well known...but just in case you forgot...here are a few highlights, courtesy of my friend Douglas Brooks, MS, Exercise Physiologist:

• **Fat Loss, Weight Control, Weight Maintenance**

One advantage resistance training offers is a leaner body. Maintaining or increasing muscle mass preserves your ability to burn higher numbers of calories. Your body is operating at a higher metabolic rate and it's easier to maintain or lose weight.

• **Increased Metabolism**

If you have a lot of muscle, your metabolism is higher and you "burn" more calories since muscle is metabolically active.

• **Increased Calorie Burning During Resistance Training**

Any activity, including strength training, burns calories during the activity and contributes to fitness.

• **Increased Calorie Burning After Exercise**

Vigorous strength training significantly elevates calorie burning (metabolic rate) anywhere from 30 to 60 minutes or longer after you've finished.

• **Reductions in Resting Blood Pressure**

If you have high blood pressure or borderline high blood pressure, generally it's acceptable to use moderate resistance and perform 15-20 repetitions to fatigue. Diet and exercise can lower blood pressure. Check with a doctor to get a specific recommendation.

• **Positive Changes in Cholesterol Profiles**

HDL cholesterol (the "good guy") is raised primarily by exercising and losing fat. Of course, diet (i.e., proper food choices) is important to lower harmful LDL (the "bad guy" cholesterol) and triglycerides (fat).

• **A Stronger Body That is Less Prone to Injuries**

Stronger muscles increase the thickness and strength of tendons (which connect muscles to bones) and ligaments (which provide integrity to joints by connecting bone-to-bone). Stronger muscles let you perform better, and with less chance of injury to the muscles, tendons, ligaments and joints.

• **Personal Physical Independence**

Many people lose their "freedom" because they've lost the strength to be mobile. Strong individuals perform better and physical activity feels good to their bodies.

• **Improved Posture**

Strength and flexibility are the keys to correct body alignment. You quite possibly will look and feel better!

• **Improved Physical Image**

Strength training will change how you look. If you don't believe this, compare a runner who only trains the cardiovascular system with an athlete who strength trains as well as participates in aerobic activity.

• **Improved Self-Esteem**

You'll feel strong, look strong and think that you're strong. In fact, you will be strong!

Now that we've reviewed why it is important to strength train, there is no question that you should do it! At the end of this section you will find my 8 week workout plan that shows you exactly how to use your Bio Force® Sport exerciser for the next eight weeks.

**PART TWO:
PROPER NUTRITION**

All of the strength training in the world can't overcome a poor diet. If you truly want to get in the best shape of your life, you need to give your body the right "fuel!" Included with your Bio Force® Sport exerciser you will find a booklet entitled "Eating Plan." The Eating Plan included was developed by a nutritionist. It includes a complete and thorough diet program designed to help you eat healthy foods and in the right portions. Review this plan carefully and follow its recommendations for the duration of the 8 week program.

**PART THREE:
AEROBIC EXERCISE**

And last but not least - aerobic exercise. This is the final piece of the "new you" puzzle. By elevating your heart rate just a few times a week, you will increase your cardiovascular endurance, burn calories and help guarantee your success. At the end of this manual you will find a complete section devoted to the benefits of aerobic exercise. Refer to the Aerobic Exercise portion of the guide for a complete rundown of aerobic activities and guidelines. For the duration of the 8 week program you should do 20 minutes of aerobic exercise 4 times a week as instructed below.

Get to it!

All right! What are we waiting for? Now is the time to begin! Make sure to incorporate all 3 parts of my plan into your "new you" program. In just 8 short weeks you are going to look and feel amazing! And don't forget to take some photos of yourself at the end of week eight... I would love to hear about your results.

8 WEEK BODY TRANSFORMATION WORKOUT

The following workout is comprised of 32 total workouts. In addition to proper eating, you will do an aerobic workout and work out on the Bio Force® Sport exerciser 4 times a week, for 8 weeks. Make sure to rest in between days.

Now when you start the Bio Force® workout, use a light amount of resistance and slowly progress up to heavier resistance. How do you know how much weight is right for you? Easy...when you are exercising, your muscles should reach fatigue at the end of the 15 reps. If they are not fatigued at the end of 15 repetitions, you need to add more resistance...and if you can't make it to 15 reps, you will need to subtract resistance.

Review how to adjust the resistance with Slide-N-Lock Technology on page 29 of this manual.

Now Let's Get Started! Here are the 32 individual Bio Force® workouts. Each contains a list of exercises you are to perform. The first number next to each exercise is the number of "sets" you are to execute. The second number indicates the numbers of "repetitions" in each set. So for the very first exercise in workout #1, 15 squats equal 1 complete set. And you are to complete three sets.

After completing your Bio Force® workout, you should finish your Body Transformation Workout by completing 20 minutes of aerobic exercise. Refer to the Aerobic Exercise portion of this manual for a complete list of aerobic exercises and additional guidelines.

Also note that before and after EVERY WORKOUT you will need to perform the general warm up, cool down, and stretching routine that is recommended in this manual. Please refer to page 25 for the specific details to the stretching, warm up, and cool down routines.



38 INCLINE CHEST FLYE

START: Sit facing away. Grip handles with arms open to sides. Palms facing front.

MOTION: Close and angle arms upward to head height. Pause at end of motion. Open and lower arms to starting position.

TIPS: Keep arms almost straight throughout exercise. Do not bend elbows at end of motion. Elbows and wrists in line with shoulders. Maintain upright posture in seated position. Contract abdominals to stabilize back.

MUSCLE GROUPS EXERCISED: Pectoralis, anterior deltoids

LEVEL OF DIFFICULTY: Intermediate

SEAT: On/Top Position

LEG LIFT: On

ACCESSORIES: Handles

MOVABLE PULLEY POSITIONS

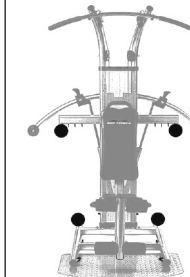

39 SINGLE ARM INCLINE CHEST FLYE

START: Sit facing away. Grip one handle with arm open to side. Palm facing front.

MOTION: Close and angle arm upward to head height. Handle to midline of forehead. Pause at end of motion. Open to starting position.

TIPS: Keep arm almost straight throughout exercise. Do not bend elbow at end of motion. Avoid rotating torso while pressing. Maintain upright posture in seated position. Contract abdominals to stabilize back. Perform on both sides.

MUSCLE GROUPS EXERCISED: Pectoralis, anterior deltoids

LEVEL OF DIFFICULTY: Intermediate/Advanced

SEAT: On/Top Position

LEG LIFT: On

ACCESSORIES: Handles

MOVABLE PULLEY POSITIONS

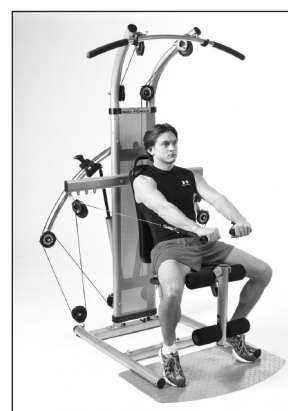
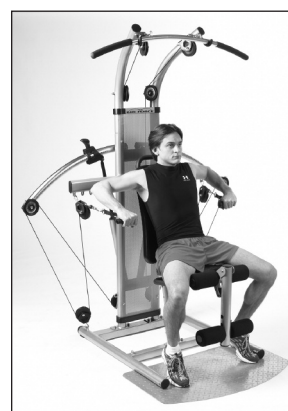
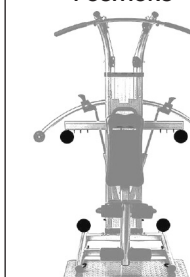

40 DECLINE CHEST PRESS

START: Sit facing away with hips forward on seat, shoulders touching backrest. Grip handles with cables under arms. Elbows bent 90 degrees at shoulder level.

MOTION: Extend elbows and press arms forward and downward. Pause at end of motion. Bend elbows back to starting position.

TIPS: Press arms downward to hip level. Keep elbows in line with shoulders and wrists straight. Maintain straight spine position while leaning back. Do not round lower back. Contract abdominals to stabilize back.

MUSCLE GROUPS EXERCISED: Pectoralis, triceps, anterior deltoids

LEVEL OF DIFFICULTY: Intermediate

SEAT: On/Top Position

LEG LIFT: On

ACCESSORIES: Handles

MOVABLE PULLEY POSITIONS

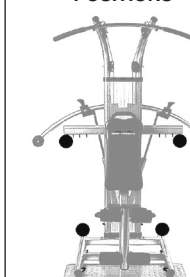



35 SINGLE ARM INCLINE CHEST PRESS

START: Sit facing away. Grip one handle with palm down. Elbow bent 90 degrees at shoulder level. Cable over arm.

MOTION: Extend elbow and press arm to upward angle. Pause at end of motion. Bend elbow back to starting position.

TIPS: Press arm forward and upward in arcing motion. Handle to head height at end of motion. Avoid rotating torso while pressing. Maintain upright posture in seated position. Contract abdominals to stabilize back. Perform on both sides.

MUSCLE GROUPS EXERCISED: Pectoralis, triceps, anterior deltoids

LEVEL OF DIFFICULTY: Intermediate/Advanced

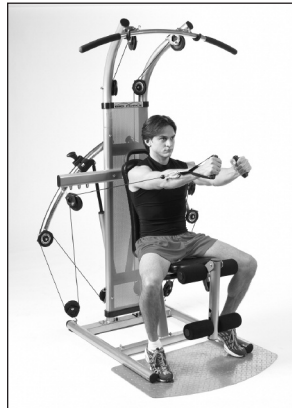

36 CHEST FLYE

START: Sit facing away. Grip handles with arms open to sides. Palms facing front.

MOTION: Close arms in front of chest. Pause at end of motion. Open arms to starting position.

TIPS: Keep arms almost straight throughout exercise. Do not bend elbows at end of motion. Elbows and wrists in line with shoulders. Maintain upright posture in seated position. Contract abdominals to stabilize back.

MUSCLE GROUPS EXERCISED: Pectoralis, anterior deltoids

LEVEL OF DIFFICULTY: Beginner

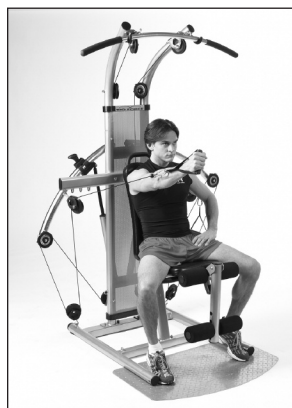

37 SINGLE ARM CHEST FLYE

START: Sit facing away. Grip one handle with arm open to side. Palm facing front.

MOTION: Close arm in front of chest. Handle to midline of chest. Pause at end of motion. Open arm to starting position.

TIPS: Keep arm almost straight throughout exercise. Do not bend elbow at end of motion. Avoid rotating torso while pressing. Maintain upright posture in seated position. Contract abdominals to stabilize back. Perform on both sides.

MUSCLE GROUPS EXERCISED: Pectoralis, anterior deltoids

LEVEL OF DIFFICULTY: Intermediate/Advanced

SEAT: On/Top Position

LEG LIFT: On

ACCESSORIES: Handles

MOVABLE PULLEY POSITIONS

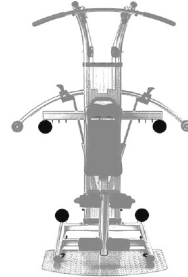

SEAT: On/Top Position

LEG LIFT: On

ACCESSORIES: Handles

MOVABLE PULLEY POSITIONS

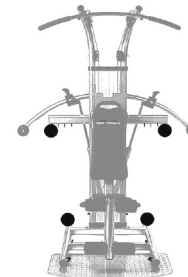

SEAT: On/Top Position

LEG LIFT: On

ACCESSORIES: Handles

MOVABLE PULLEY POSITIONS

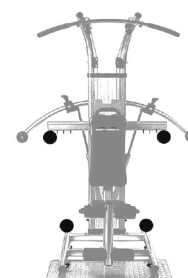

WEEK ONE

WORKOUT #1 (45 sec rest between all sets)

- Squats - 3 sets of 15 reps (3 x 15)
- Seated Chest Press - 3 x 15
- Single Leg Squats - 2 x 15
- Incline Chess Press - 2 x 15
- Seated Leg Extensions - 2 x 15
- Chest Flyes - 2 x 15
- Lat Bar Pull Down (front) - 3 x 15
- Standing Triceps Pushdowns - 3 x 15
- Ab Crunch - 2 x 15 – When bent down (flexed position) hold this position for 2 seconds before releasing to a relaxed position.
- Oblique Crunch - 2 x 15 + 15 (15 reps to the left side and 15 reps to the right side)

WORKOUT #2 (45 sec rest between all sets)

- Straight Leg Dead Lifts - 3 x 15
- Seated Shoulder Press - 3 x 15
- Leg Curls - 3 x 15 + 15
- Shoulder Shrugs, Standing Lateral Raises and Standing Front Raises - 3 x 15
- 3 sets of 15 for each exercise (3 x 15 + 15 + 15)
- Standing Hip Flexion, Lying Hip Abduction and Adduction - 3 x 10 + 10 + 10
- Standing Biceps Curls - 3 x 15
- Calf Raises - 3 x 10 + 10 + 10 (toes in, out & straight)
- Seated Spinal Extension - 3 x 15

WORKOUT #3 (45 sec rest between all sets)

- Single Leg Squats - 3 x 15 + 15
- Single Arm Seated Chest Press - 3 x 15 + 15
- Seated Single Leg Extension - 3 x 15 + 15
- Single Arm Incline Chest Press - 3 x 15 + 15
- Standing Rows - 3 x 15
- Reverse Grip Pull Down - 2 x 15
- Seated Overhead Triceps Extension - 2 x 15
- Ab Crunch - 2 x 15 – 2 second holds at flexed position
- Oblique Crunch - 2 x 15 + 15

WORKOUT #4 (45 sec rest between all sets)

- Straight Leg Dead Lifts - 4 x 15
- Single Arm Shoulder Press - 4 x 15 + 15
- Leg Curls - 4 x 15 + 15
- Shoulder Shrugs, Standing Lateral Raises and Standing Rear Deltoids Rows - 3 x 15 + 15 + 15
- Standing Hip Flexion, Lying Hip Abduction and Adduction - 3 x 10 + 10 + 10
- Standing Biceps Curls - 3 x 15
- Calf Raises - 3 x 10 + 10 + 10 (toes in, out & straight)
- Seated Spinal Extension - 3 x 15

WEEK TWO

WORKOUT #5 (60 sec rest between all sets)

- Squats - 4 x 15
- Seated Chest Press - 4 x 15
- Single Leg Squats - 2 x 12
- Incline Chest Press - 2 x 12
- Seated Leg Extensions - 2 x 12
- Chest Flyes - 2 x 12
- Lat Bar Front Pull Down - 4 x 12
- Standing Triceps Pushdowns - 4 x 15
- Ab Crunch - 3 x 15 – 2 second holds at flexed position
- Oblique Crunch - 3 x 15 + 15

WORKOUT #6 (60 sec rest between all sets)

- Straight Leg Dead Lifts - 4 x 15
- Seated Shoulder Press - 4 x 15
- Leg Curls - 4 x 15 + 15
- Shoulder Shrugs, Standing Lateral Raises and Standing Front Raises - 4 x 15 + 15 + 15
- Standing Hip Flexion, Lying Hip Abduction and Adduction - 3 x 10 + 10 + 10
- Standing Biceps Curls - 4 x 15
- Calf Raises - 4 x 10 + 10 + 10 (toes in, out & straight)
- Seated Spinal Extension - 4 x 15

WORKOUT #7 (60 sec rest between all sets)

- Single Leg Squats - 4 x 15 + 15
- Single Arm Seated Chest Press - 4 x 15 + 15
- Seated Single Leg Extension - 2 x 15 + 15
- Single Arm Incline Chest Press - 2 x 15 + 15
- Standing Rows - 4 x 15
- Reverse Grip Pull Down - 4 x 15
- Seated Overhead Triceps Extension - 4 x 15
- Ab Crunch - 3 x 15 – 2 second holds at flexed position
- Oblique Crunch - 3 x 15 + 15

WORKOUT #8 (60 sec rest between all sets)

- Straight Leg Dead Lifts - 4 x 15
- Single Arm Seated Shoulder Press - 4 x 15 + 15
- Leg Curls - 4 x 15 + 15
- Shoulder Shrugs, Standing Lateral Raises and Standing Rear Deltoids - 4 x 15+15+15
- Standing Hip Flexion, Lying Hip Abduction and Adduction - 4 x 10 + 10 + 10
- Standing Biceps Curls - 4 x 15
- Calf Raises - 3 x 10 + 10 + 10 (toes in, out & straight)
- Seated Spinal Extension - 4 x 15

WEEK THREE

WORKOUT #9 (60 sec rest between all sets)

- Squats - 4 x 12
- Seated Chest Press - 4 x 12
- Single Leg Squats - 2 x 12
- Incline Chest Press - 2 x 12
- Seated Leg Extensions - 2 x 12
- Chest Flyes - 2 x 12
- Lying Hip Extension - 3 x 10 + 10
- Lat Bar Front Pull Down - 4 x 12
- Standing Triceps Pushdowns - 4 x 12
- Ab Crunch - 3 x 12 – 3 second holds at flexed position
- Oblique Crunch - 3 x 12 + 12

WORKOUT #10 (60 sec rest between all sets)

- Straight Leg Dead Lifts - 4 x 12
- Seated Shoulder Press - 4 x 12
- Leg Curls - 4 x 12 + 12
- Shoulder Shrugs, Standing Lateral Raises and Standing Front Raises - 4 x 12 + 12 + 12
- Standing Hip Flexion, Lying Hip Abduction and Adduction - 4 x 8 + 8 + 8
- Standing Biceps Curls - 4 x 12
- Calf Raises - 4 x 10 + 10 + 10 (toes in, out & straight)
- Seated Spinal Extension - 4 x 12



32 SEATED CHEST PRESS

START: Sit facing away. Grip handles with palms down. Elbows bent 90 degrees at shoulder level. Cables under arms.

MOTION: Extend elbows and press arms straight forward. Pause at end of motion. Bend elbows back to starting position.

TIPS: Press arms forward in arcing motion. Keep elbows in line with shoulders and wrists straight. Maintain upright posture in seated position. Contract abdominals to stabilize back.

MUSCLE GROUPS EXERCISED: Pectoralis, triceps, anterior deltoids

LEVEL OF DIFFICULTY: Beginner

SEAT: On/Top Position

LEG LIFT: On

ACCESSORIES: Handles

MOVABLE PULLEY POSITIONS

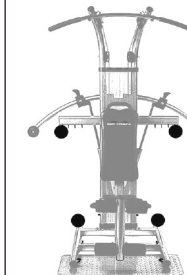

33 SINGLE ARM SEATED CHEST PRESS

START: Sit facing away. Grip one handle with palm down. Elbow bent 90 degrees at shoulder level. Cable under arm.

MOTION: Extend elbow and press arm straight forward. Pause at end of motion. Bend elbow back to starting position.

TIPS: Press arm forward in arcing motion. Keep elbow in line with shoulder and wrist straight. Avoid rotating torso while pressing. Maintain upright posture in seated position. Contract abdominals to stabilize back. Perform on both sides.

MUSCLE GROUPS EXERCISED: Pectoralis, triceps, anterior deltoids

LEVEL OF DIFFICULTY: Intermediate/Advanced

SEAT: On/Top Position

LEG LIFT: On

ACCESSORIES: Handles

MOVABLE PULLEY POSITIONS

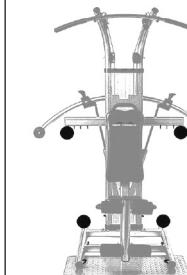

34 INCLINE CHEST PRESS

START: Sit facing away. Grip handles with palms down. Elbows bent 90 degrees at shoulder level. Cables over arms.

MOTION: Extend elbows and press arms to upward angle. Pause at end of motion. Bend elbows back to starting position.

TIPS: Press arms forward and upward in arcing motion. Handles to head height at end of motion. Keep wrists straight. Maintain upright posture in seated position. Contract abdominals to stabilize back.

MUSCLE GROUPS EXERCISED: Pectoralis, triceps, anterior deltoids

LEVEL OF DIFFICULTY: Intermediate

SEAT: On/Top Position

LEG LIFT: On

ACCESSORIES: Handles

MOVABLE PULLEY POSITIONS

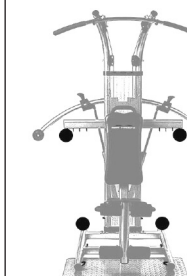

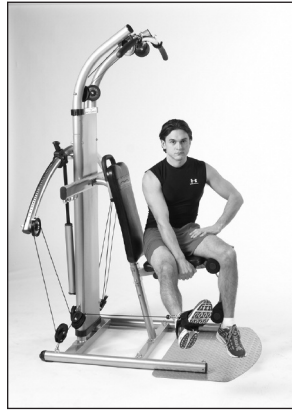

31 SEATED ANKLE INVERSION

START: Sit facing side. Foot harness/cuff on inside ankle, other foot on floor. Grip edge of seat. Lift leg off floor and rotate ankle so toes face outward.

MOTION: Rotate ankle until toes face inward. Pause at end of motion. Rotate ankle back to starting position.

TIPS: Sit up straight with abdominals contracted. Do not bend lower back. Keep rotating foot about 6 inches off floor. Perform on both sides

SEAT: On/Top Position

LEG LIFT: On

ACCESSORIES: Foot harness/Ankle cuff

MOVABLE PULLEY POSITIONS

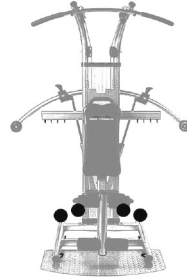

MUSCLE GROUPS EXERCISED: Ankle inverters

LEVEL OF DIFFICULTY: Beginner

WORKOUT #11 (60 sec rest between all sets)

- Single Leg Squats - 4 x 12 + 12
- Single Arm Seated Chest Press - 4 x 12 + 12
- Seated Single Leg Extension - 2 x 12 + 12
- Single Arm Incline Chest Press - 2 x 12 + 12
- Standing Rows - 4 x 12
- Reverse Grip Pull Down - 4 x 12
- Seated Overhead Triceps Extension - 4 x 12
- Ab Crunch - 2 x 12 – 2 second holds at flexed position
- Oblique Crunch - 2 x 12 + 12
- Standing Trunk Rotation - 2 x 12 + 12

WORKOUT #12 (60 sec rest between all sets)

- Straight Leg Dead Lifts - 4 x 12
- Single Arm Shoulder Press - 4 x 12 + 12
- Leg Curls - 4 x 12 + 12
- Shoulder Shrugs, Standing Lateral Raises and Standing Rear Deltoids Rows - 4 x 12 + 12 + 12
- Standing Hip Flexion, Lying Hip Abduction and Adduction - 3 x 10 + 10 + 10
- Single Arm Standing Rows - 4 x 12
- Standing Biceps Curls - 4 x 12
- Calf Raises - 4 x 10 + 10 + 10 (toes in, out & straight)
- Seated Spinal Extension - 4 x 12

WEEK FOUR WORKOUT #13 (60 sec rest between all sets)

- Squats - 4 x 12
- Seated Chest Press - 4 x 12
- Single Leg Squat - 2 x 12 + 12
- Seated Leg Extensions - 2 x 12
- Chest Flyes - 2 x 12
- Lat Bar Pull Down (front) - 4 x 12
- Standing Triceps Pushdowns - 4 x 12
- Ab Crunch - 4 x 12 – 4 second holds at flexed position
- Oblique Crunch - 2 x 12 + 12

WORKOUT #14 (60 sec rest between all sets)

- Straight Leg Dead Lifts - 4 x 12
- Seated Shoulder Press - 4 x 12
- Leg Curls - 4 x 12 + 12
- Shoulder Shrugs, Standing Lateral Raises and Standing Front Raises - 4 x 10 + 10 + 10
- Standing Hip Flexion, Lying Hip Abduction and Adduction - 4 x 10 + 10 + 10
- Standing Biceps Curls - 4 x 12
- Calf Raises - 4 x 10 + 10 + 10 (toes in, out & straight)
- Seated Spinal Extension - 4 x 12

WORKOUT #15 (60 sec rest between all sets)

- Single Leg Squats - 4 x 12 + 12
- Single Arm Seated Chest Press - 4 x 12 + 12
- Seated Single Leg Extension - 2 x 12 + 12
- Single Arm Incline Chest Press - 2 x 12 + 12
- Standing Rows - 4 x 12
- Reverse Grip Pull Down - 4 x 12
- Seated Overhead Tricep Extension - 4 x 12
- Closed Grip Chest Press - 2 x 12
- Ab Crunch - 2 x 12 – 3 second holds at flexed position
- Oblique Crunch - 2 x 12 + 12
- Standing Trunk Rotation - 2 x 12 + 12

NOTE: Starting with Workout #16 of the program you will notice that you are to complete “SUPER SETS.” What is a “Super Set?” It is simply a combination of two different exercises performed one right after the other without any rest. So for example, in Workout #16 you are to perform a Super Set consisting of Standing Biceps Curls and Standing Hammer Curls. You will do 4 sets of Biceps Curls (12 reps each) and then immediately begin performing 4 sets of the Standing Hammer Curl (8 reps each.)

WORKOUT #16 (60 sec rest between all sets)

- Straight Leg Dead Lifts - 4 x 12
- Single Arm Shoulder Press - 4 x 12 + 12
- Leg Curls - 4 x 12 + 12
- Shoulder Shrugs, Standing Lateral Raises and Standing Rear Deltoid Rows - 4 x 10 + 10 + 10
- Standing Hip Flexion, Lying Hip Abduction and Adduction - 4 x 10 + 10 + 10
- SUPER SET
 - Standing Biceps Curls - 4 x 12
 - Standing Hammer Curls - 4 x 8
- Calf Raises - 4 x 10 +10 +10 (toes in, out & straight)
- Seated Spinal Extension - 4 x 12

WEEK FIVE

WORKOUT #17 (60 sec rest between all sets)

- SUPER SET
 - Squats - 5 x 8
 - Single Leg Squats - 5 x 8
- SUPER SET
 - Seated Chest Press - 5 x 8
 - Chest Flyes - 5 x 8
- SUPER SET
 - Seated Leg Extensions - 2 x 8
 - Standing Hip Abduction - 2 x 8
- SUPER SET
 - Lat Bar Front Pull Down - 5 x 8
 - Standing Triceps Pushdowns - 5 x 8
 - Closed Grip Chest Press - 5 x 8
- Ab Crunch - 4 x 10 – 4 second holds at flexed position
- Oblique Crunch w/Twists - 4 x 10 + 10

WORKOUT #18 (60 sec rest between all sets)

- Straight Leg Dead Lifts - 5 x 8
- Seated Shoulder Press - 5 x 8
- Leg Curls - 5 x 8 + 8
- Shoulder Shrugs, Standing Lateral Raises and Standing Front Raises - 5 x 8 + 8 + 8
- Standing Hip Flexion, Lying Hip Abduction and Adduction - 5 x 8 + 8 + 8
- Standing Biceps Curls - 5 x 8
- Calf Raises - 5 x 8 + 8 + 8 (toes in, out & straight)
- Seated Spinal Extension - 5 x 8

WORKOUT #19 (60 sec rest between all sets)

- SUPER SET
 - Squats - 5 x 8
 - Single Leg Squats - 5 x 8 + 8
- SUPER SET
 - Seated Chest Press - 5 x 8
 - Single Arm Seated Chest Press - 5 x 8 + 8
- SUPER SET
 - Seated Leg Extension - 2 x 8
 - Leg Curls - 2 x 8
- SUPER SET
 - Single Arm Incline Chest Press - 2 x 8 + 8
 - Single Arm Standing Rows - 2 x 8 + 8
- SUPER SET
 - Reverse Grip Pull Down - 5 x 8
 - Standing Triceps Pushdowns - 5 x 8
- Ab Crunch - 3 x 10 – 4 second holds - while flexed
- Oblique Crunch - 2 x 10 + 10

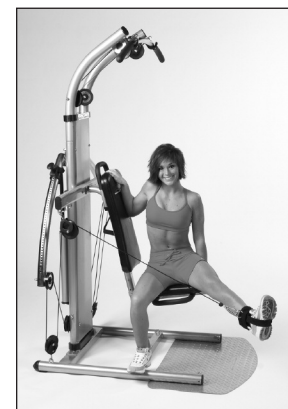

28 SEATED SINGLE LEG ABDUCTION

START: Sit facing side. Foot harness/cuff on outside ankle, other foot on floor. Lift leg parallel to floor. Grip top of seat.

MOTION: Open leg to the side, toes facing up. Pause at end of motion. Return to starting position.

TIPS: Sit up straight with abdominals contracted. Do not bend lower back. Keep knees and toes pointing upward as leg abducts. Perform on both sides.

MUSCLE GROUPS EXERCISED: Hip abductors

LEVEL OF DIFFICULTY: Intermediate/Advanced

SEAT: On/Bottom Position

LEG LIFT: Off

ACCESSORIES: Foot harness/Ankle cuff

MOVABLE PULLEY POSITIONS

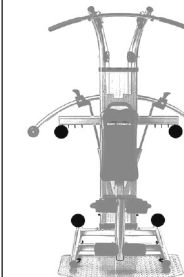

29 SEATED SINGLE LEG ADDUCTION

START: Sit facing away. Foot harness/cuff on one ankle, other foot on floor. Grip seat. Open leg to the side, parallel with floor.

MOTION: Pull leg into midline of body. Pause at end of motion. Open leg to starting position.

TIPS: Sit up straight with abdominals contracted. Do not bend lower back. Keep knees and toes pointing upward as leg adducts. Perform on both sides.

MUSCLE GROUPS EXERCISED: Hip adductors

LEVEL OF DIFFICULTY: Intermediate/Advanced

SEAT: On/Bottom Position

LEG LIFT: Off

ACCESSORIES: Foot harness/Ankle cuff

MOVABLE PULLEY POSITIONS

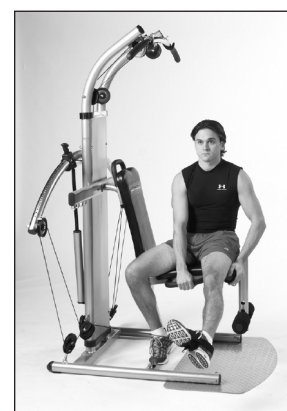
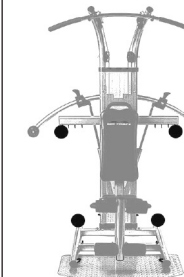

30 SEATED ANKLE EVERSION

START: Sit facing side. Foot harness/cuff on outside ankle, other foot on floor. Grip edge of seat. Lift leg off floor and rotate ankle so toes face inward.

MOTION: Rotate ankle until toes face outward. Pause at end of motion. Rotate ankle back to starting position.

TIPS: Sit up straight with abdominals contracted. Do not bend lower back. Keep rotating foot about 6 inches off floor. Perform on both sides.

MUSCLE GROUPS EXERCISED: Ankle everters

LEVEL OF DIFFICULTY: Beginner

SEAT: On/Top Position

LEG LIFT: On

ACCESSORIES: Foot harness/Ankle cuff

MOVABLE PULLEY POSITIONS

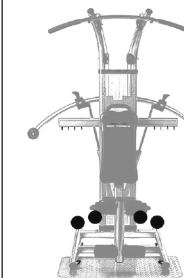



25 LYING HIP ROTATION

START: Lie on back facing away, shoulders on base. Foot harnesses/cuffs on ankles. Grip base of frame. Lift legs 6 inches off floor.

MOTION: Open both legs to the side. Continue in upward circular motion until legs are over hips. Lower to starting position. Reverse direction of motion.

TIPS: Keep legs straight while moving in circular pattern. Do not excessively arch back off floor. Contract abdominals to stabilize back. Perform in both directions.

SEAT: Off

LEG LIFT: Off

ACCESSORIES: Foot harness/Ankle cuff

MOVABLE PULLEY POSITIONS

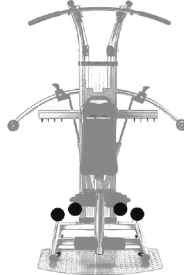

MUSCLE GROUPS EXERCISED:

Gluteals, hamstrings, hip adductors, hip flexors, abdominals

LEVEL OF DIFFICULTY:

Intermediate/Advanced



26 SINGLE LEG LYING HIP ROTATION

START: Lie on back facing away, shoulders on base. Foot harnesses/cuffs on ankles. Grip base of frame. Lift legs 6 inches off floor.

MOTION: Open one leg to the side. Continue in upward circular motion until leg is over hip. Lower to starting position. Reverse direction of motion.

TIPS: Keep leg straight while moving in circular pattern. Do not excessively arch back off floor. Contract abdominals to stabilize back. Perform in both directions. Perform on both sides.

SEAT: Off

LEG LIFT: Off

ACCESSORIES: Foot harness/Ankle cuff

MOVABLE PULLEY POSITIONS

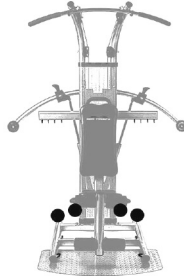

MUSCLE GROUPS EXERCISED:

Gluteals, hamstrings, hip adductors, hip flexors, abdominals

LEVEL OF DIFFICULTY:

Advanced



27 SEATED SINGLE LEG PRESS

START: Sit facing away. Foot harness/cuff on one ankle, other foot on floor. Bend knee and lift foot to seat height. Grip seat.

MOTION: Extend knee until leg is straight and parallel to floor. Pause at end of movement. Bend knee to starting position.

TIPS: Sit up straight with abdominals contracted. Keep knees and toes pointing upward. Press leg forward. Do not allow leg to open to the side. Perform on both sides.

SEAT: On/Bottom Position

LEG LIFT: Off

ACCESSORIES: Foot harness/Ankle cuff

MOVABLE PULLEY POSITIONS

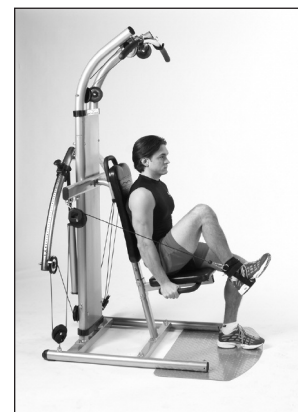
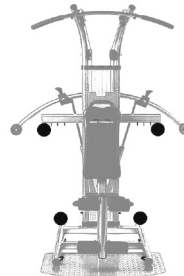

MUSCLE GROUPS EXERCISED: Gluteals, quadriceps, hamstrings

LEVEL OF DIFFICULTY: Beginner

WORKOUT #20 (60 sec rest between all sets)

- Straight Leg Dead Lifts - 5 x 8
- Single Arm Shoulder Press - 5 x 8 + 8
- Leg Curls - 5 x 8 + 8
- Shoulder Shrugs, Standing Lateral Raises and Standing Rear Deltoid Rows - 5 x 8 + 8 + 8
- Standing Hip Flexion, Lying Hip Abduction and Adduction - 3 x 8 + 8 + 8
- Standing Biceps Curls - 5 x 8
- Calf Raises - 5 x 8 + 8 + 8 (toes in, out & straight)
- Seated Spinal Extension - 5 x 8

WEEK SIX

WORKOUT #21 (60 sec rest between all sets)

- SUPER SET • Single Leg Squats - 5 x 8 + 8
- Squats - 5 x 8
- Squats - 1 x ? – Do one set for 45 seconds doing as many as possible without stopping
- SUPER SET • Single Arm Seated Chest Press - 5 x 8
- Seated Chest Press - 5 x 8
- Seated Chest Press - 1 x ? – Do one set for 45 seconds doing as many as possible without stopping
- Seated Leg Extensions - 2 x 8
- SUPER SET • Chest Flyes - 5 x 8
- Lat Bar Front Pull Down - 2 x 8
- Lat Bar Pull Downs - 1 x ? – Do one set for 45 seconds doing as many as possible without stopping
- Ab Crunch - 4 x 10 – 5 second holds - while flexed
- Oblique Crunch - 2 x 10 + 10
- Standing Trunk Rotation - 2 x 12 + 12

WORKOUT #22 (60 sec rest between all sets)

- Straight Leg Dead Lifts - 5 x 8
- Seated Shoulder Press - 5 x 8
- Leg Curls - 5 x 8 + 8
- Shoulder Shrugs, Standing Lateral Raises and Standing Front Raises - 5 x 8 + 8 + 8
- Standing Hip Flexion, Lying Hip Abduction and Adduction - 5 x 8 + 8 + 8
- Standing Biceps Curls - 5 x 8
- Calf Raises - 5 x 8 + 8 + 8 (toes in, out & straight)
- Seated Spinal Extension - 5 x 8

WORKOUT #23 (60 sec rest between all sets)

- SUPER SET • Single Leg Squats - 4 x 8, 1 x 12
- Squats - 4 x 8, 1 x 12
- SUPER SET • Single Arm Seated Chest Press - 4 x 8 + 8, 1 x 12 + 12
- Seated Chest Press - 4 x 8, 1 x 12
- SUPER SET • Seated Leg Extension - 2 x 8 + 8, 1 x 12 + 12
- Leg Curls - 2 x 8, 1 x 12
- SUPER SET • Incline Chest Press - 1 x 8, 1 x 12
- Standing Rows - 1 x 8, 1 x 12
- SUPER SET • Reverse Grip Pull Down - 3 x 8, 1 x 12
- Seated Overhead Triceps Extension - 3 x 8, 1 x 12
- Closed Grip Chest Press - 3 x 8, 1 x 12
- SUPER SET • Ab Crunch - 3 x 8, 1 x 12 – 4 second holds at flexed position
- Oblique Crunch - 3 x 8 + 8, 1 x 12 + 12

WORKOUT #24 (60 sec rest between all sets)

- Straight Leg Dead Lifts - 3 x 8, 1 x 12
- Single Arm Shoulder Press - 3 x 8 + 8, 1 x 12 + 12
- Leg Curls - 1 x 8 + 8, 3 x 6 + 6
- Shoulder Shrugs, Standing Lateral Raises and Standing Rear Deltoid Rows - 3 x 8 + 8 + 8, 1 x 12 + 12 + 12
- Standing Hip Flexion, Lying Hip Abduction and Adduction - 3 x 8 + 8 + 8, 1 x 12 + 12 + 12
- SUPER SET
 - Standing Biceps Curls - 3 x 8, 1 x 12
 - Standing Hammer Curls - 3 x 8, 1 x 12
- Calf Raises - 3 x 8 + 8 + 8, 1 x 12 + 12 + 12 (toes in, out & straight)
- Seated Spinal Extension - 3 x 8, 1 x 12

WEEK SEVEN
WORKOUT #25 (60 sec rest between all sets)

- SUPER SET
 - Single Leg Squats - 2 x 10 + 10, 2 x 15 + 15, 1 x 20 + 20
 - Squats - 2 x 10, 2 x 15, 1 x 20
- SUPER SET
 - Single Arm Seated Chest Press - 2 x 10 + 10, 2 x 15 + 15, 1 x 20 + 20
 - Seated Chest Press - 2 x 10, 2 x 15, 1 x 20
- SUPER SET
 - Seated Leg Extensions - 1 x 10, 1 x 15, 1 x 20
 - Leg Curls - 1 x 10, 1 x 15, 1 x 20
- SUPER SET
 - Chest Flyes - 2 x 10, 2 x 15, 1 x 20
 - Lat Bar Front Pull Down - 2 x 10, 2 x 15, 1 x 20
- SUPER SET
 - Closed Grip Chest Press - 2 x 10, 2 x 15, 1 x 20
 - Seated Overhead Triceps Extension - 2 x 10, 2 x 15, 1 x 20
- SUPER SET
 - Ab Crunch - 2 x 10, 2 x 15, 1 x 20 – 5 second holds at flexed position
 - Oblique Crunch - 2 x 10 + 10, 2 x 15 + 15, 1 x 20 + 20

WORKOUT #26 (60 sec rest between all sets)

- Straight Leg Dead Lifts - 2 x 10, 2 x 15, 1 x 20
- Seated Shoulder Press - 2 x 10, 2 x 15, 1 x 20
- Leg Curls - 2 x 10 + 10, 2 x 15 + 15, 1 x 20 + 20
- Shoulder Shrugs, Standing Lateral Raises and Standing Front Raises - 2 x 10 + 10 + 10, 2 x 15 + 15 + 15, 1 x 20 + 20 + 20
- Standing Hip Flexion, Lying Hip Abduction and Adduction - 2 x 10 + 10 + 10, 2 x 15 + 15 + 15, 1 x 20 + 20 + 20
- Standing Biceps Curls - 2 x 10, 2 x 15, 1 x 20
- Calf Raises - 2 x 10 + 10 + 10, 2 x 15 + 15 + 15, 1 x 20 + 20 + 20 (toes in, out & straight)
- Seated Spinal Extension - 2 x 10 + 10, 2 x 15 + 15, 1 x 20 + 20

WORKOUT #27 (60 sec rest between all sets)

- Single Leg Squats - 2 x 10, 2 x 15, 2 x 20
- Single Arm Seated Chest Press - 2 x 10 + 10, 2 x 15 + 15, 2 x 20 + 20
- Seated Single Leg Extension - 1 x 10 + 10, 1 x 15 + 15, 1 x 20 + 20
- Single Arm Incline Chest Press - 1 x 10 + 10, 1 x 15 + 15, 1 x 20 + 20
- SUPER SET
 - Standing Rows - 2 x 10, 2 x 15, 2 x 20
 - Reverse Grip Pull Down - 2 x 10, 2 x 15, 2 x 20
- SUPER SET
 - Seated Overhead Triceps Extension - 2 x 10, 2 x 15, 2 x 20
 - Closed Grip Chest Press - 2 x 10, 2 x 15, 2 x 20
- SUPER SET
 - Ab Crunch - 2 x 10, 2 x 15, 2 x 20 – 4 second holds at flexed position
 - Oblique Crunch - 2 x 10 + 10, 2 x 15 + 15, 2 x 20 + 20



MUSCLE GROUPS EXERCISED: Gluteals, quadriceps, hamstrings, abdominals

LEVEL OF DIFFICULTY: Beginner



MUSCLE GROUPS EXERCISED: Gluteals, hamstrings

LEVEL OF DIFFICULTY: Beginner

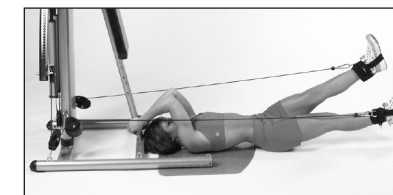
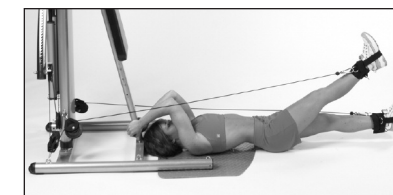

MUSCLE GROUPS EXERCISED: Gluteals, hamstrings, abdominals

LEVEL OF DIFFICULTY: Intermediate

22 LYING SINGLE LEG PRESS

START: Lie on back facing away, shoulders on base. Foot harnesses/cuffs on ankles. Grip base of frame. Bend hip and knee of one leg.

MOTION: Extend hip and knee until leg is straight. Pause at end of motion. Return to starting position.

TIPS: Keep knee in line with shoulder throughout exercise. Do not excessively arch back off floor as leg extends. Contract abdominals to stabilize back. Perform on both sides.

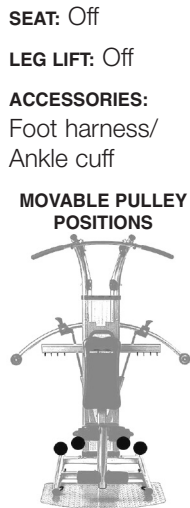
23 SCISSOR KICKS

START: Lie on back facing away, shoulders on base. Foot harnesses/cuffs on ankles. Grip base of frame. Lift one leg perpendicular to floor.

MOTION: Lower leg straight down to floor. Simultaneously lift other leg. Continue alternating legs in “scissor” motion.

TIPS: Keep legs straight while lifting and lowering. Do not allow legs to open to the side. Keep knees in line with shoulders throughout exercise. Do not excessively arch back off floor. Contract abdominals to stabilize back.



24 FLUTTER KICKS

START: Lie on back facing away, shoulders on base. Foot harnesses/cuffs on ankles. Grip base of frame. Lift one leg 12 inches off floor.

MOTION: Lower leg straight down to floor. Simultaneously lift other leg 12 inches off floor. Continue alternating legs in small “flutter” motion.

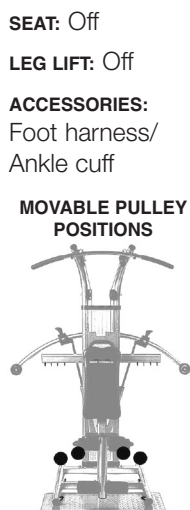
TIPS: Keep legs straight while lifting and lowering. Do not allow legs to open to the side. Keep knees in line with shoulders throughout exercise. Do not excessively arch back off floor. Contract abdominals to stabilize back.

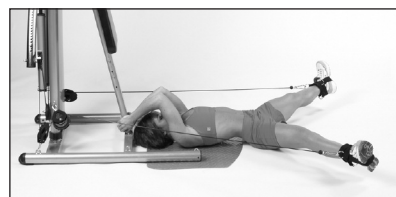
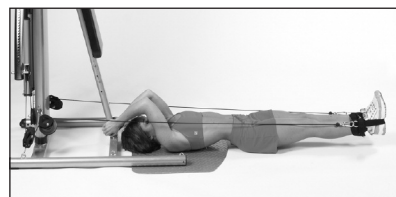



MUSCLE GROUPS EXERCISED: Hip adductors, hip flexors, abdominals

LEVEL OF DIFFICULTY: Intermediate/Advanced

19 LYING HIP ABDUCTION/ ADDUCTION

START: Lie on back facing away, shoulders on base. Foot harnesses/cuffs on ankles. Grip base of frame. Lift legs 6 inches off floor.

MOTION: Open both legs to the side. Pause at end of motion. Close legs back to starting position.

TIPS: Keep both legs straight and lifted off floor while opening and closing. Do not excessively arch back off floor. Contract abdominals to stabilize back. Modify by lowering one leg to floor and performing on one side.

SEAT: Off

LEG LIFT: Off

ACCESSORIES: Foot harness/ Ankle cuff

MOVABLE PULLEY POSITIONS

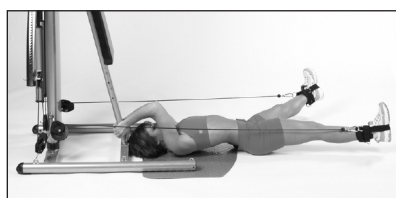
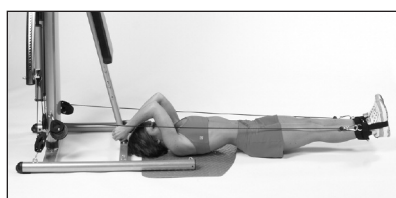
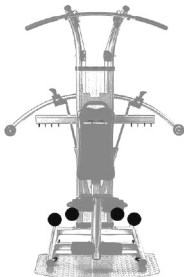

MUSCLE GROUPS EXERCISED: Hip adductors, hip flexors, abdominals

LEVEL OF DIFFICULTY: Advanced

20 LYING SINGLE LEG ABDUCTION/ ADDUCTION

START: Lie on back facing away, shoulders on base. Foot harnesses/cuffs on ankles. Grip base of frame. Lift legs 6 inches off floor.

MOTION: Open one leg to the side. Pause at end of motion. Close leg back to starting position.

TIPS: Keep non-moving leg straight and lifted off floor while opening and closing other leg. Do not excessively arch back off floor. Contract abdominals to stabilize back. Modify by lowering non-moving leg to floor. Perform on both sides.

SEAT: Off

LEG LIFT: Off

ACCESSORIES: Foot harness/ Ankle cuff

MOVABLE PULLEY POSITIONS

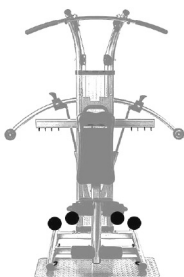

MUSCLE GROUPS EXERCISED: Gluteals, quadriceps, hamstrings, abdominals

LEVEL OF DIFFICULTY: Intermediate/Advanced

21 LYING DOUBLE LEG PRESS

START: Lie on back facing away, shoulders on base. Foot harnesses/cuffs on ankles. Grip base of frame. Bend hips and knees.

MOTION: Extend hips and knees until legs are straight. Pause at end of motion. Return to starting position.

TIPS: Keep knees in line with shoulders throughout exercise. Do not excessively arch back off floor as legs extend. Contract abdominals to stabilize back.

SEAT: Off

LEG LIFT: Off

ACCESSORIES: Foot harness/ Ankle cuff

MOVABLE PULLEY POSITIONS

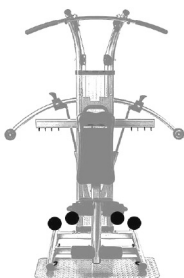

WORKOUT #28 (60 sec rest between all sets)

- Straight Leg Dead Lifts - 2 x 10, 2 x 15, 2 x 20
- Single Arm Shoulder Press - 2 x 10 + 10, 2 x 15 + 15, 2 x 20 + 20
- Leg Curls - 2 x 10 + 10, 2 x 15 + 15, 2 x 20 + 20
- Single Arm Shoulder Shrugs, Standing Lateral Raises and Standing Rear Deltoid Row - 2 x 10 + 10, 2 x 15 + 15, 2 x 20 + 20
- Standing Hip Flexion, Lying Hip Abduction and Adduction - 2 x 10 + 10 + 10, 2 x 15 + 15 + 15, 2 x 20 + 20 + 20
- Standing Biceps Curls - 2 x 10, 2 x 15, 2 x 20
- Calf Raises - 2 x 10 + 10 + 10, 2 x 15 + 15 + 15, 2 x 20 + 20 + 20 (toes in, out & straight)
- Seated Spinal Extension - 2 x 10, 2 x 15, 2 x 20

WEEK EIGHT WORKOUT #29 (60 sec rest between all sets)

- Squats - 1 x 15, 1 x 10, 1 x 8, 1 x 6, x 15
- Seated Chest Press - 1 x 15, 1 x 10, 1 x 8, 1 x 6, 1 x 15
- Seated Leg Extensions - 1 x 15, 1 x 10, 1 x 8, 1 x 6, 1 x 15
- Chest Flyes - 1 x 15, 1 x 10, 1 x 8, 1 x 6, 1 x 15
- Lat Bar Front Pull Down - 1 x 15, 1 x 10, 1 x 8, 1 x 6, 1 x 15
- Standing Triceps Pushdowns - 1 x 15, 1 x 10, 1 x 8, 1 x 6, 1 x 15
- Ab Crunch - 1 x 15, 1 x 10, 1 x 8, 1 x 6, 1 x 15
- Oblique Crunch - 1 x 15 + 15, 1 x 10 + 10, 1 x 8 + 8, 1 x 6 + 6, 1 x 15 + 15

WORKOUT #30 (60 sec rest between all sets)

- Straight Leg Dead Lifts - 1 x 15, 1 x 10, 1 x 8, 1 x 6, 1 x 15
- Seated Shoulder Press - 1 x 15, 1 x 10, 1 x 8, 1 x 6, 1 x 15
- Leg Curls - 1 x 15 + 15, 1 x 10 + 10, 1 x 8 + 8, 1 x 6 + 6, 1 x 15 + 15
- Shoulder Shrugs, Standing Lateral Raises and Standing Front Raises - 1 x 15 + 15 + 15, 1 x 10 + 10 + 10, 1 x 8 + 8 + 8, 1 x 6 + 6 + 6, 1 x 15 + 15 + 15
- Standing Hip Flexion, Lying Hip Abduction and Adduction - 1 x 15 + 15 + 15, 1 x 10 + 10 + 10, 1 x 8 + 8 + 8, 1 x 6 + 6 + 6, 1 x 15 + 15 + 15
- Standing Biceps Curls - 1 x 15, 1 x 10, 1 x 8, 1 x 6, 1 x 15
- Calf Raises - 1 x 15 + 15 + 15, 1 x 10 + 10 + 10, 1 x 8 + 8 + 8, 1 x 6 + 6 + 6, 1 x 15 + 15 + 15 (toes in, out & straight)
- Seated Spinal Extension - 1 x 15 + 15, 1 x 10 + 10, 1 x 8 + 8, 1 x 6 + 6, 1 x 15 + 15

WORKOUT #31 (60 sec rest between all sets)

- Single Leg Squats - 2 x 15 + 15, 2 x 10 + 10, 2 x 8 + 8, 2 x 6 + 6, 1 x 15 + 15
- Single Arm Seated Chest Press - 2 x 15 + 15, 2 x 10 + 10, 2 x 8 + 8, 2 x 6 + 6, 1 x 15 + 15
- Seated Single Leg Extension - 2 x 15 + 15, 2 x 10 + 10, 2 x 8 + 8, 2 x 6 + 6, 1 x 15 + 15
- Single Arm Incline Chest Press - 2 x 15 + 15, 2 x 10 + 10, 2 x 8 + 8, 2 x 6 + 6, 1 x 15 + 15
- Reverse Grip Pull Down - 2 x 15, 2 x 10, 2 x 8, 2 x 6, 1 x 15
- Seated Overhead Triceps Extension - 2 x 15, 2 x 10, 2 x 8, 2 x 6, 1 x 15
- Ab Crunch - 2 x 15, 2 x 10, 2 x 8, 2 x 6, 1 x 15
- Standing Trunk Rotation - 2 x 15 + 15, 2 x 10 + 10, 2 x 8 + 8, 2 x 6 + 6, 1 x 15 + 15

WORKOUT #32 (60 sec rest between all sets)

- Straight Leg Dead Lifts - 2 x 15, 2 x 10, 2 x 8, 2 x 6, 1 x 15
- Single Arm Shoulder Press - 2 x 15 + 15, 2 x 10 + 10, 2 x 8 + 8, 2 x 6 + 6, 1 x 15 + 15
- Leg Curls - 2 x 15 + 15, 2 x 10 + 10, 2 x 8 + 8, 2 x 6 + 6, 1 x 15 + 15
- Standing Hip Flexion, Lying Hip Abduction and Adduction - 1 x 15 + 15 + 15, 1 x 10 + 10 + 10, 1 x 8 + 8 + 8, 1 x 6 + 6 + 6, 1 x 15 + 15 + 15
- Standing Biceps Curls - 2 x 15, 2 x 10, 2 x 8, 2 x 6, 1 x 15
- Calf Raises - 1 x 15 + 15 + 15, 1 x 10 + 10 + 10, 1 x 8 + 8 + 8, 1 x 6 + 6 + 6, 1 x 15 + 15 + 15 (toes in, out & straight)
- Seated Spinal Extension - 2 x 15, 2 x 10, 2 x 8, 2 x 6, 1 x 15

When performing these stretches, your movements should be slow and smooth, with no bouncing or jerking. Move into the stretch until you feel a slight tension, not pain, in the muscle and hold the stretch for 20 to 30 seconds. Breathe slowly and rhythmically. Be sure not to hold your breath. Remember that all stretches must be done for both sides of your body.

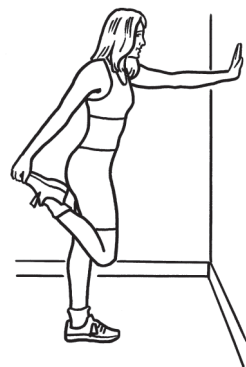

1. Quadriceps Stretch

Stand close to a wall, chair or other solid object. Use one hand to assist your balance. Bend the opposite knee and lift your heel towards your buttocks. Reach back and grasp the top of your foot with the same side hand. Keeping your inner thighs close together, slowly pull your foot towards your buttocks until you feel a gentle stretch in the front of your thigh. You do not have to touch your buttocks with your heel. Stop pulling when you feel the stretch. Keep your kneecap pointing straight down and keep your knees close together. (Do not let the lifted knee swing outward.)

Hold for 20 to 30 seconds. Repeat for the other leg.

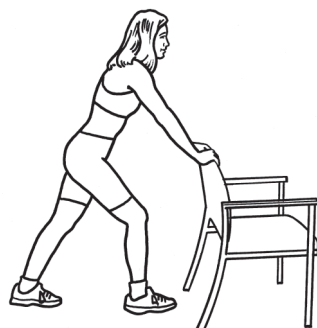

2. Calf and Achilles Stretch

Stand approximately one arms length away from a wall or chair with your feet hip-width apart. Keeping your toes pointed forward, move one leg in close to the chair while extending the other leg behind you. Bending the leg closest to the chair and keeping the other leg straight, place your hands on the chair. Keep the heel of the back leg on the ground and move your hips forward. Slowly lean forward from the ankle, keeping your back leg straight until you feel a stretch in your calf muscles.

Hold for 20 to 30 seconds. Repeat for the opposite leg.



3. Overhead/Triceps Stretch

Stand with your feet shoulder width apart and your knees slightly bent. Lift one arm overhead and bend your elbow, reaching down behind your head with your hand toward the opposite shoulder blade. Walk your fingertips down your back as far as you can. Hold this position. Reach up with your opposite hand and grasp your flexed elbow. Gently assist the stretch by pulling on the elbow.

Hold for 20 to 30 seconds. Repeat for the opposite arm.



16 STANDING HIP ABDUCTION

START: Stand facing side. Foot harness/cuff on outside ankle, inside foot on base. Grip the top of the backrest.

MOTION: Lift leg to side, toes facing front. Pause at end of motion. Lower to starting position.

TIPS: Keep leg straight while lifting. Lift leg directly to side. Avoid angling leg front or back, or lifting toes. Maintain upright body position. Do not tip body as leg lifts. Contract abdominals to stabilize back. Perform on both sides.

MUSCLE GROUPS EXERCISED: Hip abductors

LEVEL OF DIFFICULTY: Beginner



17 STANDING HIP ADDUCTION

START: Stand facing side. Foot harness/cuff on inside ankle, outside foot on base. Grip the top of the backrest.

MOTION: Pull inside leg across supporting leg, toes facing front. Pause at end of motion. Return to starting position.

TIPS: Pull working leg in front of supporting leg. Maintain upright body position. Do not tip body as leg pulls across. Contract abdominals to stabilize back. Perform on both sides.

MUSCLE GROUPS EXERCISED: Hip adductors

LEVEL OF DIFFICULTY: Beginner



18 LYING HIP EXTENSION

START: Lie on back facing away, shoulders on base. Foot harnesses/cuffs on ankles. Grip base of frame. Lift one leg perpendicular to floor.

MOTION: Lower leg straight down to floor. Pause at end of motion. Slowly raise to starting position.

TIPS: Keep leg straight while lifting and lowering. Do not allow leg to open to the side. Keep knee in line with shoulder throughout exercise. Do not excessively arch back off floor. Contract abdominals to stabilize back. Perform on both sides.

MUSCLE GROUPS EXERCISED: Gluteals, hamstrings

LEVEL OF DIFFICULTY: Beginner

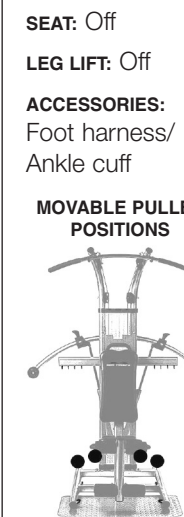
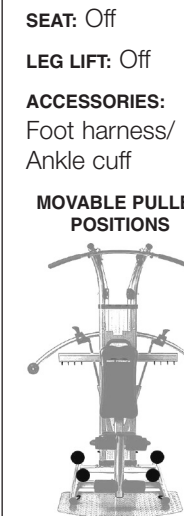

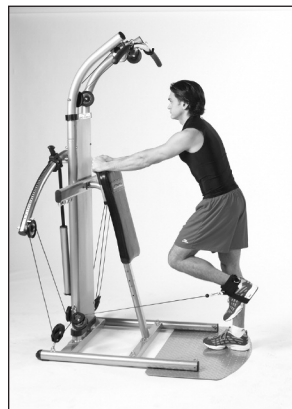

13 STANDING LEG PRESS

START: Stand facing frame. Foot harness/cuff on one ankle, other foot on base. Grip the top of the backrest with both hands. Bend hip and knee of working leg.

MOTION: Extend hip and knee. Press leg straight back behind body. Pause at end of motion. Flex hip and knee back to starting position.

TIPS: Keep arms straight to stabilize torso. Maintain forward lean with straight back. Contract abdominals to stabilize back. Perform on both sides.

MUSCLE GROUPS EXERCISED: Gluteals, hamstrings, quadriceps

LEVEL OF DIFFICULTY: Beginner



14 STANDING HIP FLEXION

START: Stand facing away. Foot harness/cuff on one ankle, other foot on base. Place hands on hips.

MOTION: Flex hip and raise leg until thigh is parallel to floor. Pause at top of motion. Lower to starting position.

TIPS: Maintain upright body position. Do not lean forward or back as leg lifts. Contract abdominals to stabilize back. Perform on both sides.

MUSCLE GROUPS EXERCISED: Hip flexors

LEVEL OF DIFFICULTY: Advanced

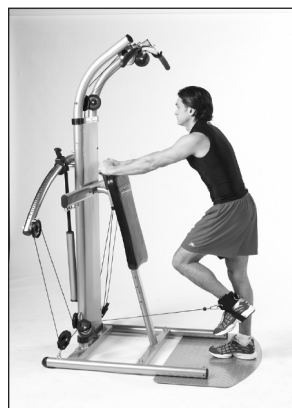

15 STANDING HIP EXTENSION

START: Stand facing frame. Foot harness/cuff on one ankle, other foot on base. Grip the top of the backrest with both hands. Bend knee 90 degrees in front of body.

MOTION: Extend hip. Pull thigh in line with or slightly behind standing leg. Pause at end of motion. Return to starting position.

TIPS: Keep knee bent while extending hip. Maintain forward lean with straight back. Keep arms straight to stabilize torso. Contract abdominals to stabilize back. Perform on both sides.

MUSCLE GROUPS EXERCISED: Gluteals, hamstrings

LEVEL OF DIFFICULTY: Beginner

SEAT: Off

LEG LIFT: Off

ACCESSORIES: Foot harness/ Ankle cuff

MOVABLE PULLEY POSITIONS

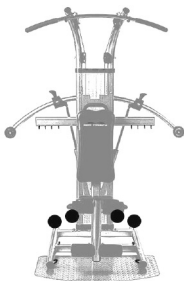

SEAT: Off

LEG LIFT: Off

ACCESSORIES: Foot harness/ Ankle cuff

MOVABLE PULLEY POSITIONS

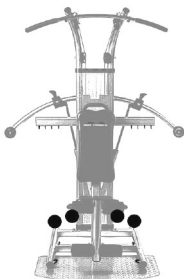

SEAT: Off

LEG LIFT: Off

ACCESSORIES: Foot harness/ Ankle cuff

MOVABLE PULLEY POSITIONS

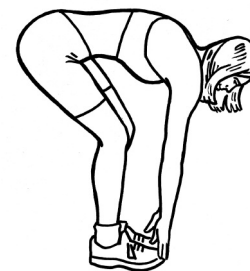
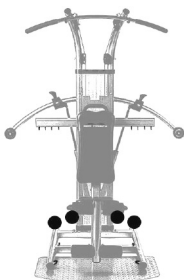

4. Back Stretch

Stand with your legs shoulder width apart and your knees slightly bent. Bend forward from your waist with your arms extending loosely in front of your body. Gently bend from the waist flexing your body as far forward as it will go.

Hold for 20 to 30 seconds. Straighten up and repeat.



5. Standing Hamstrings Stretch

Stand with your legs hip-width apart. Extend one leg out in front of you and keep that foot flat against the ground. With your hands resting lightly on your thighs, bend your back leg and lean forward slightly from your hips until you feel a stretch in the back of your thigh. Be sure to lean forward from the hip joint rather than bending at your waist.

Hold for 20 to 30 seconds. Repeat for the opposite leg.



6. Buttocks and Hips Stretch

Lay flat on your back with your hips relaxed against the floor. Bend one leg at the knee. Keeping both shoulders flat on the floor, gently grasp the bent knee with your hands and pull it over your body and towards the ground. You should feel a stretch in your hips, abdominals and lower back.

Hold for 20 to 30 seconds and release. Repeat for opposite side.



7. Inner Thigh Stretch

Sit on the floor and bend your legs so that the soles of your feet are together. Place your elbows on your knees. Lean forward from the waist and press down lightly on the inside of your knees. You should feel a stretch in the muscles of your inside thigh.

Hold for 20 to 30 seconds and release.



8. Arm Pullback

Stand with your feet shoulder width apart and toes pointing forward and with your knees slightly bent. Let your arms hang relaxed on either side of your body. Expand your chest and pull your shoulders back. Bend your elbows slightly and clasp your hands behind your back. Slowly straighten your arms as you lift your hands upward. Raise your hands upward until you feel mild tension in your shoulder and chest region.

Hold for 20 to 30 seconds. Lower your arms to their original position and bend your elbows. Release your hands and return them to your sides.

Note: The unit shown in the following exercise photos may differ slightly from the unit you purchased.

Developing Your Bio Force® Workout

The choices you make about the frequency (how often), the duration (how long), and intensity (how hard) at which you will workout, will directly influence your results.

Before beginning any workouts on the Bio Force® Sport exerciser, you should first determine your current fitness level. The following are guidelines that you can use to determine your fitness level, but remember these are just guidelines. You must always listen to your body. Start out at a level that is comfortable to you and progress sensibly.

Beginner – No previous exercise experience, or have not exercised in a long time.

Intermediate – Have been performing exercises regularly for three months or more.

Advanced – Have been performing exercises regularly for six months or more.

LEGS

1. Squat
2. Single Leg Squat
3. Reverse Lunge
4. Seated Leg Extension
5. Seated Single Leg Extension
6. Straight Leg Dead Lift
7. Straight Bar Dead Lift
8. Leg Curls
9. Calf Raises
10. Eversion Calf Raises
11. Inversion Calf Raises
12. Single Leg Kick Back
13. Standing Leg Press
14. Standing Hip Flexion
15. Standing Hip Extension
16. Standing Hip Abduction
17. Standing Hip Adduction
18. Lying Hip Extension
19. Lying Hip Abduction/Adduction
20. Lying Single Leg Abduction/Adduction
21. Lying Double Leg Press
22. Lying Single Leg Press
23. Scissor Kicks
24. Flutter Kicks
25. Lying Hip Rotation
26. Single Leg Lying Hip Rotation
27. Seated Single Leg Press
28. Seated Single Leg Abduction
29. Seated Single Leg Adduction
30. Seated Ankle Eversion
31. Seated Ankle Inversion

LEGS



10 EVERSION CALF RAISES

START: Stand facing frame. Feet hip width apart on base. Toes facing outward. Grip handles at sides of body.

MOTION: Raise heels, bending at balls of feet. Pause at top of movement. Lower heels to starting position.

TIPS: Keep arms and legs straight. Contract abdominals to stabilize back. Maintain upright position of torso. Do not lean or bend forward or back.

MUSCLE GROUPS EXERCISED: Gastrocnemius, soleus

LEVEL OF DIFFICULTY: Intermediate/Advanced

SEAT: Off

LEG LIFT: Off

ACCESSORIES: Handles

MOVABLE PULLEY POSITIONS

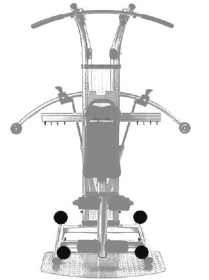

11 INVERSION CALF RAISES

START: Stand facing frame. Feet hip width apart on base. Toes facing inward. Grip handles at sides of body.

MOTION: Raise heels, bending at balls of feet. Pause at top of movement. Lower heels to starting position.

TIPS: Keep arms and legs straight. Contract abdominals to stabilize back. Maintain upright position of torso. Do not lean or bend forward or back.

MUSCLE GROUPS EXERCISED: Gastrocnemius, soleus

LEVEL OF DIFFICULTY: Intermediate/Advanced

SEAT: Off

LEG LIFT: Off

ACCESSORIES: Handles

MOVABLE PULLEY POSITIONS

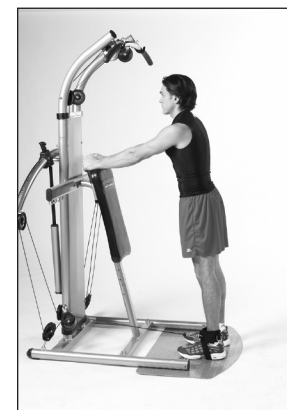
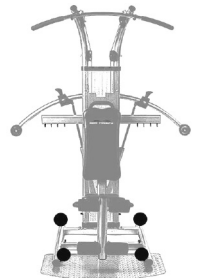

12 SINGLE LEG KICK BACK

START: Stand facing frame. Foot harness/cuff on one ankle, other foot on base. Lean forward from hips. Grip the top of the backrest with both hands.

MOTION: Extend hip. Pull leg straight back behind body. Pause at end of motion. Lower to starting position.

TIPS: Keep leg straight while lifting. Maintain forward lean with straight back. Keep arms straight to stabilize torso. Contract abdominals to stabilize back. Perform on both sides.

MUSCLE GROUPS EXERCISED: Gluteals, hamstrings

LEVEL OF DIFFICULTY: Beginner

SEAT: Off

LEG LIFT: Off

ACCESSORIES: Foot harness/ Ankle cuff

MOVABLE PULLEY POSITIONS

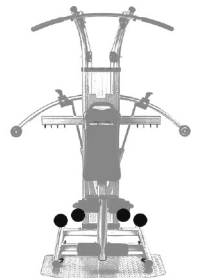



7 STRAIGHT BAR DEAD LIFT

START: Stand facing frame. Feet hip width apart on base with knees bent. Bend forward at hips and grip lat bar in front of shins.

MOTION: Extend hips and back. Stand upright, pulling bar to front thighs. Bend knees and hips and lower to starting position.

TIPS: Keep arms and back straight with chest and head lifted. Hinge up and down from hips. Do not round lower back. Contract abdominals to stabilize back. Bend forward until a slight stretch is felt in hamstrings.

MUSCLE GROUPS EXERCISED: Hamstrings, lumbar spinal extensors, gluteals

LEVEL OF DIFFICULTY: Intermediate/Advanced



8 LEG CURLS

START: Stand facing frame. One thigh against top leg bar pad. Same side ankle under bottom leg pad. Grip the top of the backrest with same side arm.

MOTION: Flex knee until lower pad is near buttocks. Pause at top of movement. Lower to starting position.

TIPS: Lean slightly forward with entire body. Keep back straight while curling leg. Contract abdominals to stabilize back. Do not lift thigh away from upper leg bar pad. Perform on both sides.

MUSCLE GROUPS EXERCISED: Hamstrings

LEVEL OF DIFFICULTY: Beginner



9 CALF RAISES

START: Stand facing frame. Feet hip width apart on base. Toes facing forward. Grip handles at sides of body.

MOTION: Raise heels, bending at balls of feet. Pause at top of movement. Lower heels to starting position.

TIPS: Keep arms and legs straight. Contract abdominals to stabilize back. Maintain upright position of torso. Do not lean or bend forward or back.

MUSCLE GROUPS EXERCISED: Gastrocnemius, soleus

LEVEL OF DIFFICULTY: Beginner

SEAT: Off
LEG LIFT: Off
ACCESSORIES: Lat Bar/Front Position

MOVABLE PULLEY POSITIONS

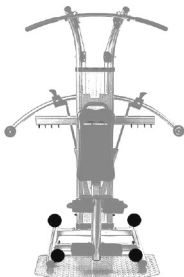

SEAT: On/Top Position
LEG LIFT: On
ACCESSORIES: None

MOVABLE PULLEY POSITIONS

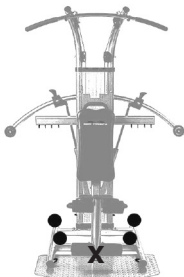

SEAT: Off
LEG LIFT: Off
ACCESSORIES: Handles

MOVABLE PULLEY POSITIONS

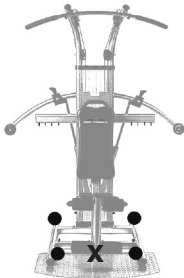

CHEST & BACK

32. Seated Chest Press
33. Single Arm Seated Chest Press
34. Incline Chest Press
35. Single Arm Incline Chest Press
36. Chest Flye
37. Single Arm Chest Flye
38. Incline Chest Flye
39. Single Arm Incline Chest Flye
40. Decline Chest Press
41. Closed Grip Chest Press
42. Lat Bar Pull Down
43. Lat Bar Front Pull Down
44. Single Arm Overhand Pull Down
45. Reverse Grip Pull Down
46. Single Arm Reverse Grip Pull Down
47. Neutral Grip Pull Down
48. Single Arm Neutral Grip Pull Down
49. Seated Pull Over
50. Single Arm Seated Pull Over
51. Straight Arm Lateral Pull Down
52. Single Straight Arm Lateral Pull Down
53. Standing Row - Neutral Position
54. Single Arm Standing Row - Neutral Position
55. Standing Row - Overhand Position
56. Single Arm Standing Row - Overhand Position
57. Standing Row - Underhand Position
58. Single Arm Standing Row - Underhand Position
59. Standing Straight Arm Pull Down

SHOULDERS

60. Seated Shoulder Press
61. Single Arm Shoulder Press
62. Shoulder Shrugs
63. Upright Row
64. Standing Front Raise
65. Single Arm Standing Front Raise
66. Standing Lateral Raise
67. Single Arm Standing Lateral Raise
68. Standing Rear Deltoid Rows
69. Single Arm Standing Rear Deltoid Rows
70. Rear Cable Crossover
71. Seated Front Raise

72. Single Arm Seated Front Raise
73. Seated Lateral Raise
74. Single Arm Seated Lateral Raise
75. Rotator Cuff - Low External Rotation
76. Rotator Cuff - Internal Rotation
77. Rotator Cuff - High External Rotation
78. Straight Arm Pull-Back
79. Rotator Cuff - Diagonal External Rotation
80. Rotator Cuff - Diagonal Internal Rotation

ARMS

81. Standing Biceps Curl
82. Single Arm Standing Biceps Curl
83. Standing Hammer Curl
84. Single Arm Standing Hammer Curl
85. Standing Reverse Curl
86. Single Arm Standing Reverse Curl
87. Curved Bar Biceps Curl
88. Curved Bar Reverse Biceps Curl
89. Seated Concentration Curl
90. Seated Wrist Curl
91. Seated Reverse Wrist Curl
92. Seated Overhead Triceps Extension
93. Single Arm Overhead Triceps Extension
94. Standing Triceps Pushdown
95. Reverse Grip Triceps Pushdown
96. Split Grip Triceps Pushdown
97. Single Arm Triceps Pushdown
98. Single Arm Reverse Grip Triceps Pushdown
99. Single Arm Triceps Kickback
100. Single Arm Reverse Grip Triceps Kickback
101. Two Arm Triceps Kickback
102. Two Arm Reverse Grip Triceps Kickback
103. Triceps Dips
104. Single Arm Triceps Dips
105. Cross-Body Triceps Extension

ABS & LOWER BACK

106. Ab Crunch
107. Oblique Crunch
108. Standing Trunk Rotation
109. Side Bend
110. Seated Spinal Extension



1 SQUAT

START: Stand facing frame. Feet hip width apart on base. Grip handles at shoulders.

MOTION: Flex knees, hips and ankles. Lower until thighs are parallel to floor or slightly higher. Press up to starting position.

TIPS: Keep knees in line with toes. Center weight over arches, not toes or heels. Lift chest and keep back straight as hips lower. Keep head lifted and in line with spine. Contract abdominals to stabilize back.

SEAT: Off

LEG LIFT: Off

ACCESSORIES: Handles

MOVABLE PULLEY POSITIONS

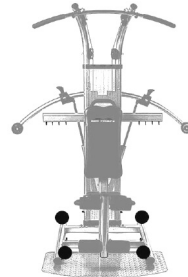

MUSCLE GROUPS EXERCISED: Gluteals, hamstrings, quadriceps

LEVEL OF DIFFICULTY: Beginner



2 SINGLE LEG SQUAT

START: Stand facing frame. Split-leg stance with back heel lifted. Grip handles at shoulders.

MOTION: Flex knees, hips and ankles. Lower until front thigh is parallel to floor or slightly higher. Press up to starting position.

TIPS: Keep weight on front leg and front knee in line with toes. Align shoulders over hips. Lift chest and keep back straight while lowering. Contract abdominals to stabilize back. Perform on both sides.

SEAT: Off

LEG LIFT: Off

ACCESSORIES: Handles

MOVABLE PULLEY POSITIONS

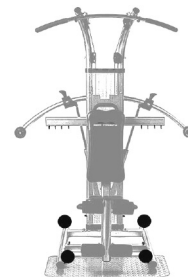

MUSCLE GROUPS EXERCISED: Gluteals, hamstrings, quadriceps

LEVEL OF DIFFICULTY: Intermediate/Advanced



3 REVERSE LUNGE

START: Stand facing frame. Feet hip width apart on base. Grip handles in front of shoulders.

MOTION: Step back with one leg into lunge position. Lower until front thigh is parallel to floor or slightly higher. Press back up to starting position.

TIPS: Keep weight on front leg and front knee in line with toes. Lift chest and keep back straight while lowering. Contract abdominals to stabilize back. Perform on both sides.

SEAT: Off

LEG LIFT: Off

ACCESSORIES: Handles

MOVABLE PULLEY POSITIONS

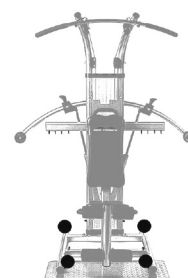

MUSCLE GROUPS EXERCISED: Gluteals, hamstrings, quadriceps

LEVEL OF DIFFICULTY: Intermediate/Advanced



4 SEATED LEG EXTENSION

START: Sit facing away. Knees over top leg pads. Ankles under bottom leg bar pads. Grip seat.

MOTION: Extend knees until legs are straight. Pause at top of movement. Lower to starting position.

TIPS: Sit up straight with abdominals contracted. Do not lean back against seat. Keep knee caps aligned with movement point of bar.

SEAT: On/Top Position

LEG LIFT: On

ACCESSORIES: None

MOVABLE PULLEY POSITIONS

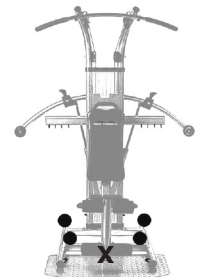

MUSCLE GROUPS EXERCISED: Quadriceps

LEVEL OF DIFFICULTY: Beginner



5 SEATED SINGLE LEG EXTENSION

START: Sit facing away. Knees over top leg bar pads. Ankles under bottom leg bar pads. Grip seat.

MOTION: Extend one knee until leg is straight. Pause at top of movement. Lower to starting position.

TIPS: Sit up straight with abdominals contracted. Do not lean back against seat. Keep knee caps aligned with movement point of bar. Perform on both sides.

SEAT: On/Top Position

LEG LIFT: On

ACCESSORIES: None

MOVABLE PULLEY POSITIONS

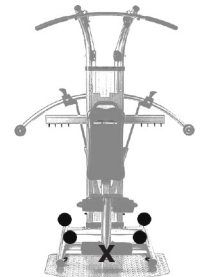

MUSCLE GROUPS EXERCISED: Quadriceps

LEVEL OF DIFFICULTY: Intermediate/Advanced



6 STRAIGHT LEG DEAD LIFT

START: Stand facing away. Feet hip width apart on base. Bend at hips and grip handles between legs.

MOTION: Extend hips and back. Stand upright, pulling handles up to front of pelvis. Bend at hips and lower to starting position.

TIPS: Keep arms and legs straight. Hinge up and down from hips. Do not round lower back or bend knees. Contract abdominals to stabilize back. Bend forward until chest is parallel to floor or slightly higher and a slight stretch is felt in hamstrings.

SEAT: Off

LEG LIFT: Off

ACCESSORIES: Handles

MOVABLE PULLEY POSITIONS

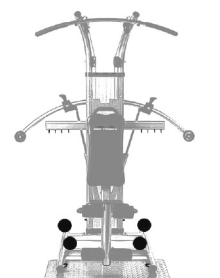

MUSCLE GROUPS EXERCISED: Hamstrings, lumbar spinal extensors

LEVEL OF DIFFICULTY: Intermediate/Advanced