

A33-5 FULL BODY AIR-MASSAGE CHAIR
OPERATION INSTRUCTIONS

SAVE THESE INSTRUCTIONS

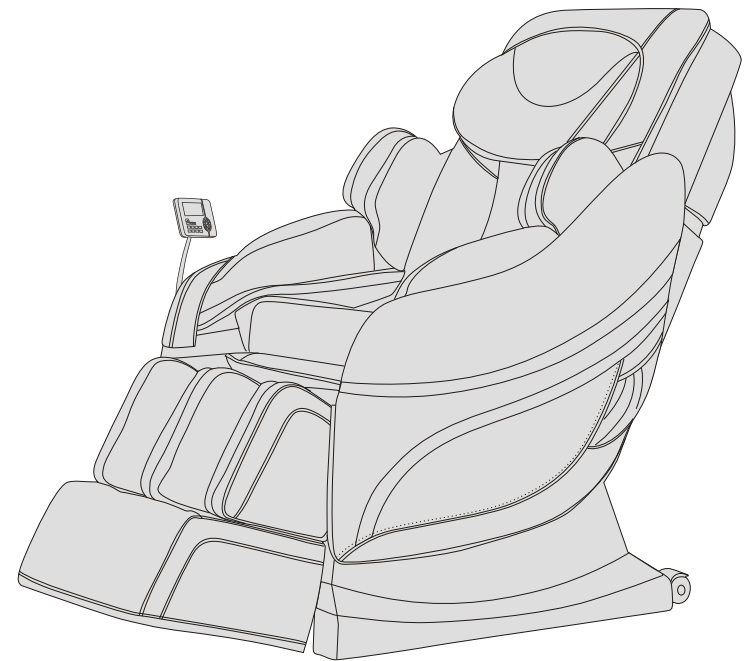

Thanks for purchasing this product. Please read this manual instruction carefully in order to know how to use this product correctly before operation. Please pay more attention to some important safety warning and keep this manual book properly for future use.

Note: Our Company reserves the right to revise the design and description of this product without any further notice. Please refer to the actual color of this product.

CONTENTS

Safety and maintenance	02
Name and function of components	04
Function	05
Method of usage	06
Product specification	19

Safety and maintenance

1. IMPORTANT SAFETY WARNING.



- Don't allow children to touch moveable part of this product.
- Please use well-grounding power supply suited to this product.
- Please pull out the plug after use or before cleaning to avoid injury or Damage to the product.
- Please operate this product according to this manual instruction.
- Don't use accessories which are not recommended.
- Don't use this product outdoors.
- Please read this manual instruction carefully before operation.
- Any other usage that is not listed in this manual instruction is forbidden.
- 20 minutes of usage each time is recommended.
- Please don't use it if the leather is broken or damaged.
- Please don't use it if the cover or leather is damaged.
- Please don't use it if the radiator hole is covered or blocked.
- Please don't drop anything into this product.
- Please don't fall asleep while using this product.
- Please don't use it if drunk or feel unwell.
- Please don't use it within one hour after having meal.
- Please don't make the massage function too strong for avoiding Injury.

2. Environment for usage.

- Please don't use it under high temperature and moist environment such as bathroom.
- Please don't use it immediately while the environmental temperature changes sharply.
- Please don't use it under heavy-dusty or caustic environment.
- Please don't use it where there is not enough space or not good ventilation.

3. People who are not suitable to use this product.

- People who are suffering from osteoporosis are not suitable to use this product.
- People who are suffering from heart disease or carrying electronic medical equipment such as heart pacemaker are not suitable to use this product.
- People who are suffering from fever are not suitable to use this product.
- Pregnant women or women that are in menses period are not suitable to use this product.
- People who got injured or skin disease are not suitable to use this product.
- Children under 14-year old or people mentally unbalanced without being Supervised are not allowed to use this machine.
- People who are told by doctor to have rest or people who feel unwell are not suitable to use this product.
- People whose bodies are wet are forbidden to use this product.
- The appliance has a heated surface. persons insensitive to Heat must be careful when using the appliance.

4. Safety.

- Check the voltage if it is suitable to the specification of this product.
- Don't use wet hand to pull the plug.

Safety and maintenance

- Don't make water go inside this product to avoid electric shock or cause damage to this product.
- Don't damage the wires or change the circuit of this product.
- Don't use wet cloth to clean the electric parts such as switch and plug.
- Be away from this product under power cut state to avoid injury if the power comeback suddenly.
- Stop using this product while it works abnormal, and please consult local agent immediately.
- Stop using this product if you feel unwell, and please consult health care doctor.
- This appliance is not intended for use by persons (including children) with reduced physical, sensory or mental capabilities, or lack of experience and knowledge, unless they have been given supervision or instruction concerning use of the appliance by a person responsible for their safety.
- Children should be supervised to ensure that they do not play with the appliance.
- If the supply cord is damaged, it must be replaced by the manufacturer, its Service agent or similarly qualified persons in order to avoid a hazard.

5. Maintenance.

- This product should be maintained by certain appointed agents, users are prohibited to disassemble or maintain by themselves.
- Please don't forget to cut the power after usage.
- Don't use this product if the socket looses.
- If this product will be left unused for long, please curl up the wires and reserve this product in dry and dustless environment.
- Don't reserve this product under high temperature or near fire and avoid longtime direct sunshine.
- If the detachable cord / supply cord is damaged, it must be replaced by the manufacturer, its service agent or similarly qualified persons in order to avoid a Hazard.
- Please clean this product by dry cloth. Don't use thinner, benzene or alcohol.
- The mechanical components of this product are specially designed and made, it is not necessary to be specially maintained.
- Don't use edged res to thrust this product.
- Don't roll or pull this product above uneven ground, it should be lifted before moving.
- Please use it intermittently; don't make this product work continuously for long.

6. Solution of ordinary malfunctions.

- It is nature movement voice if the motor sounds while in usage.
- If the controller can't work normally, please check the plug and socket if they are connected strongly and make sure the switch is turned on.
- If the rated working time is over, the product will automatically activate the power-off button; If this product works continuously for long, the temperature protector will make the product automatically power-off, it should be used again after half an hour's rest.

Name and function of components

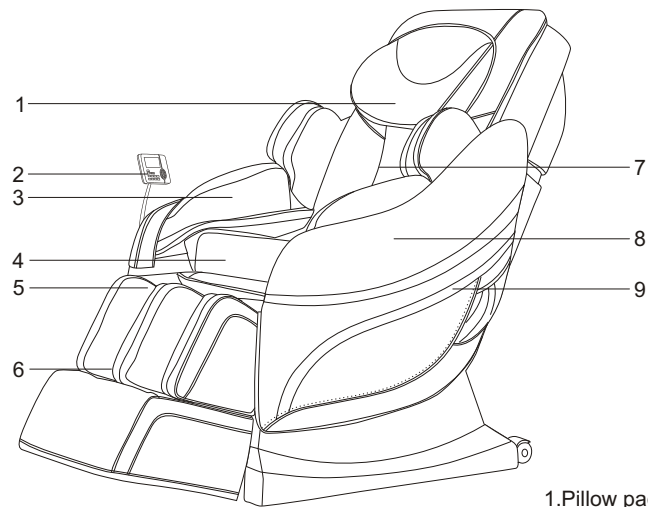

1. Pillow pad
2. Controller
3. Arm air bag components
4. Seat cushion
5. Leg rest frame
6. Foot rest frame
7. backrest pad
8. Armrest
9. remote controller pocket

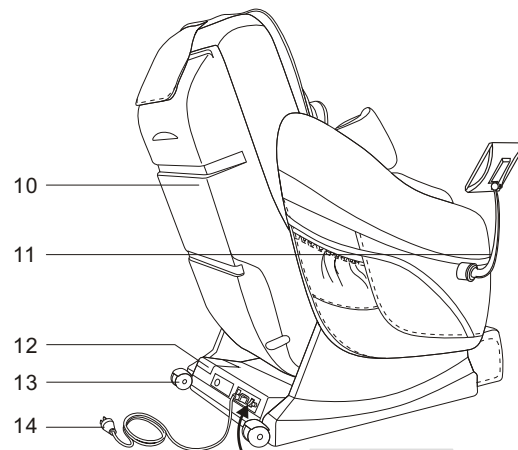

10. backrest cover
11. Controller support
12. MP3 Player Box
13. Moving wheels
14. Power cord and plug

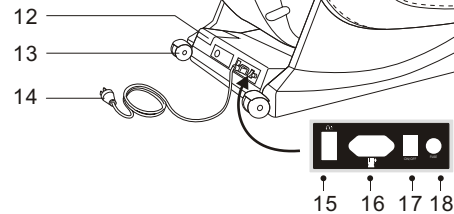

15. Earphone socket
16. power plug socket
17. Power switch
18. Fuse box

Function

Functions

- This Product is designed with a set of smart 3D mechanical hands, which can move up and down, stretching back and forth, four-wheel driven with muted design.
- The shoulder part is designed with automatic detection and micro adjustment function; body curve and massage points automatic detection, it can automatically adjust the distance of massage hands' moving back and forth according to the detected body curve and massage points, to make the massage more humanistic and scientific.
- Designed with automatic massage programs.
- Set with three kinds memo massage functions
- Automatic , Air pressure, waist twist, swing hip, waist stretch and other specific massage functions.
- Manually select the upper body massage; three massage points options of overall, partial and fixed position; six massage methods of shoulder grasping, kneading, fapping, shiatsu, kneading & flapping and 3D; five massage speed levels available; under tapping and shiatsu massage status, the width of the massage hand can be adjusted in five levels.
- Arm air pressure massage function(built -in 26airbags),with 3 intensity adjustments.
- Upper-body air massage: back air pressure massage function(built-in 4airbags)seat air pressure massage function(built-in 16airbags),calf air pressure massage function(built-in 38airbags)
- Mp3 music displayer, pause, previous, next, volume up, volume down.
- Back heating function. Use carbon fiber as infrared heating source.
- The footrest can be extended to suit various heights.
- Footrest lifting and backrest lift adjustment.
- Auto-sitting function, massage massage hands can automatically return to original position after turning off.
- VFD display.
- Mp3 player, earphones, U disc.

Method of usage

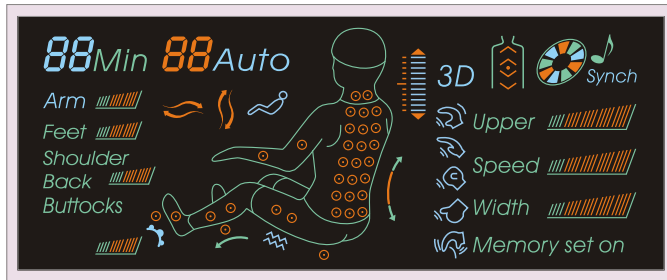

NOTE: this is for reference only, please take practicality as standard

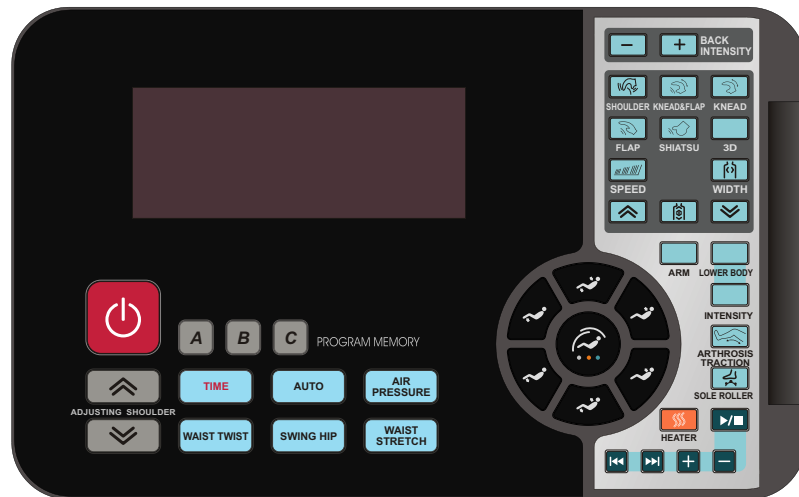

Method of usage

1. Switch power supply on

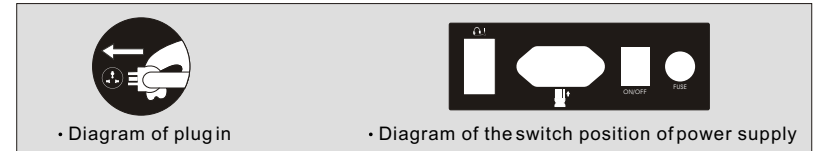

2. Start massage

- Press red power button for a short time ,backrest and calf position will lie down automatically,start massage ;Press red power button for a long time ,backrest and calf position will not lie down ,start massage.
- Automatically detecting shoulder position and massage points, please wait till dection finished.
- It sounds [di di di...] after detection finished. Now, please adjust the shoulder position by pressing up or down button. It will run automatic massage if there is no adjustment on shoulder position within 10 seconds.

Move the massage balls upward to a suitable position		
Move the massage balls downward to a suitable position		

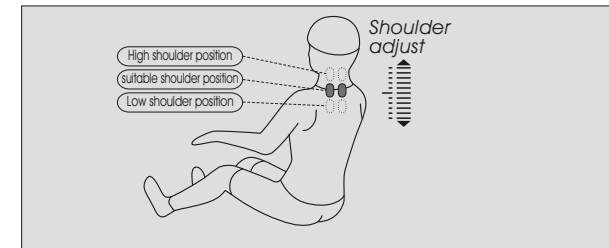

- Choose massage methods
- Memory massage
- When you are massaging, you can use A, B, C memory button at any time, press one of the button, then will back to the stored massage models to massage.







Method of usage

• Timing set

Buttons	description
	Rated time is 20 minutes. Max working time is 40 minutes. Every time press on timing set button add to 5 more minutes. Working time up to 40 minutes, press on timing set button return to 5 minutes. Follow by cycle.





- Choose massage methods

• Automatic massage

Buttons	description	display
	Relax: relax muscles and bones	Auto F1
	Ease: accelerate blood circulation	Auto F2
	Ache Release: make deep massage to relax the ache position	Auto F3
	Fatigue recover: release the fatigue and activate body	Auto F4

Note: Press the buttons repeatedly and choose different automatic massage methods, the four automatic massage methods can run circularly.

• Specific massage

Buttons	description	display
	Whole body air bags :waist、 buttock 、 arm、 calf air Bags can work at the same time.	Auto F5
	Waist twist: focus on waist massage, the waist airbags make waist twist leftside and rightside, meantime the seat airbags make hip-swing massage	Auto F6
	Swing Hip: focus on hip massage, swing hip mechanism and seat cushion pressure operating makes hip swing Left and right	Auto F7
	Waist stretch: When the calf airbags work and squeeze calf part, the backrest lays down and calfrest pulls down to stretch the waist part, then return to original position and repeat above actions. Meantime the seat airbags and massage mechanism works.	Auto F8









Method of usage

• Back Intensity Setting

Buttons	description	display
	Back weaken button: press this button, weaken the strength of upper body massage	Upper 
	Back strengthen button: press this button, strengthen the strength of upper body massage	Upper 

• Manual functions









Buttons	description	display
	Grasp: built in 1 massage method, speed and strength adjustable	 (H1)
	Kneading & taping: built in 1 massage method, speed and strength adjustable	 (H1)
	Kneading: built in 1 massage method, speed and strength adjustable	 (H1)
	Taping: built in 2 massage methods, speed, width and strength adjustable	 (H1-H2)
	Shiatsu: built in 2 massage methods, speed width and strength adjustable	 (H1-H2)
	3 D: built in 4 massage methods, speed and strength adjustable	3D (H1-H4)
	Speed: with 5 levels available	Speed 
	Width: 5 levels available (in taping and kneading massage mode)	Width 

Buttons	description	display
	Fixed position (fixed point) massage	
	Small area (partial) massage back and forth	
	Upper body (overall) back and forth	
	Massage position adjust (can adjust the massage position in fixed position, partial mode)	Mechanical hands move downward
		Mechanical hands move upward

Note: back stretch (except shoulder grasp, other manual modes are effective)

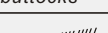



Method of usage

• Air pressure massage

Buttons	description	display
 ARM	Arms: press this button, the arm air pressure and upper arm air pressure massage function on, arm air pressure strength has 3 levels adjustable	Arm 
 LOWER BODY	Lower body: press this button and choose lower body air pressure massage function (including lower body, back and waist, calf)	Feet  Back  buttocks 
 INTENSITY	Intensity: air pressure massage intensity of lower body, back and waist, calf. Three intensity available.	
 ARTHROSIS TRACTION	The function of calf stretch will be enabled automatically under the mode of lower body air pressure massage and calf air pressure massage.	

Note: Under automatic massage status, it can adjust the relative air massage strength by pressing any button of Arm, Upper-body and Foot

• Other manual function







Buttons	description	display
 SOLE ROLLER	Sole roller: sole roller switch, with 3 speed levels available	
 HEATER	Warm therapy: back heating and knee heating switch, has warm feeling when it start to work 3 minutes later.	

• Music

Buttons	description	display
	Music on and off	
	Previous	
	Next	
	Volume up	
	Volume down	

Method of usage

3.The angle of back rest and calf rest

Buttons	description	display
	Auto lay down mode: with 4 auto lay down modes, when press the button, turn into one mode.	Auto (01 ~ 04)
	Calf rest lifting button: press this button, calf rest lifting slowly, stop when release it.	
	Calf rest decline button: press this button, calf rest decline slowly, stop when release it.	
	Back rest lifting button: press this button, back rest lifting slowly, stop when release it.	
	Back rest decline button: press this button, back rest decline slowly, stop when release it.	
	Linkage upward: press this button, the back rest lifting slowly, and the calf rest decline slowly at the same time, stop when release it.	
	Linkage downward: press this button, the back rest decline slowly, and the calf rest lifting slowly at the same time, stop when release it.	

4.Shut off power and finish massage

- Press red power button during massage to stop all massage functions immediately, the backrest and footrest will return to original position automatically. After rated working time, all massage functions will be finished but backrest and footrest won't return to original position.
- After rated working time or switch off, the handle controller displayed "Memory Set On" and glitter, and remind the users whether need to store the massage mode before turn off, you can choose the memo function buttons A, B, C as your requirement, store the massage mode. Press the red button again, the machine turn off, and the massage hands will restore to the original position, or wait for 10 seconds, the machine turn off automatically, and the massage restore to the original position.

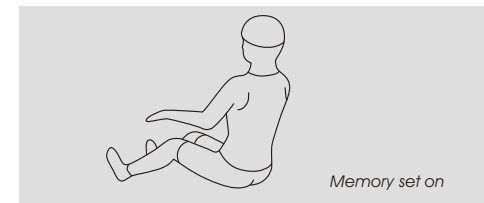

Method of usage

- Switch power off
- Figure (switch power off)



5.How to download mp3 music :

- Turn off the power of massage chair .
- Pull out the u-disk from the MP3 player .
- Insert the u-disk into USB port of PC (Windows Xp、 Windows 2000、 WindowsNT.)
- Download your favorite MP3 format music into U-disk .if fails , please firstly format the disk.
- Delete the USB Mass Storage Device on the PC after complete download .
- Pull out the U-disk from PC
- Insert U-disk to the USB port of MP3 player
- Now MP3 music was renewed . you may turn on the power of massage chair .

Note :

- If fails to play MP3 music ,please firstly format the U-disk on PC before Download.Then follow the instruction to insert the U-disk into USB port of Mp3 player.
- Except the U-disk , do not remove or loose the MP3 player .

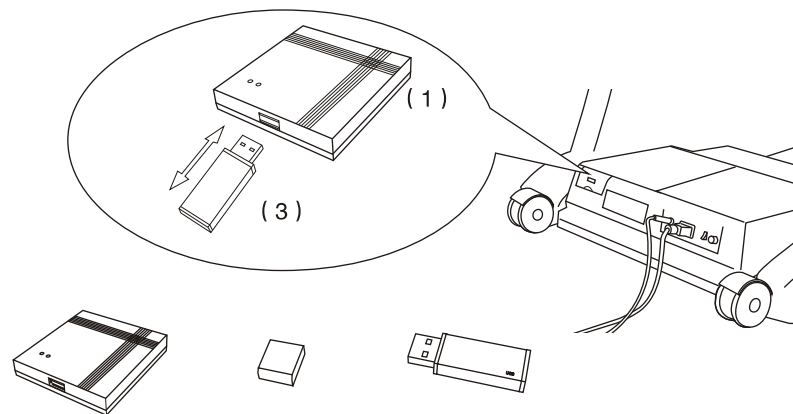

(1) MP3 player (2) U-disk front cover (3) U-disk

Method of usage

6. Amrest installation and notice.

- Check if the inner supporting gear are well fixed onto related seat frame position. (Figure 1)
- Pull the zip on the lower edge of the armrest.
- Open the big and small cover outside the armrest(shown as figure 2)
- Lift the armrest and ready to install on the chair, pull air-pipe and valve from the Seat frame and cross them through relative hole on the armrest side.(figure 3)
- Push the sliding sets in the front part of armrest into the inner supporting Gear.(figure 4)
- Push the end of the armrest into the revolving shaft.(figure 5)

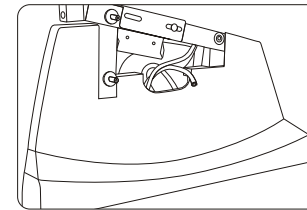

Figure1

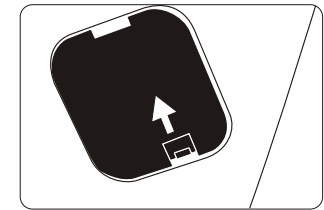

Figure2

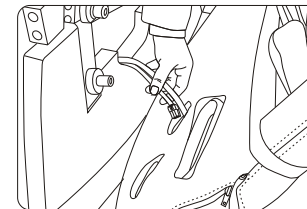

Figure3

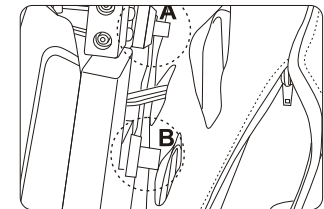

Figure4

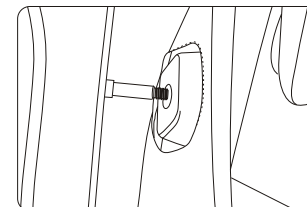
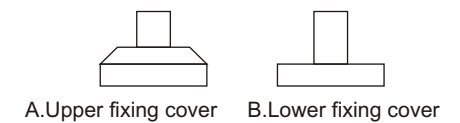

Figure5



A.Upper fixing cover B.Lower fixing cover

Method of usage

- Gently hold the armrest side. When revolve the shaft, firstly put into cage ring, then put into big washer and wrest the locknut by specialized tools. (Figure 6).
- Thread the socket head cap screws into upper tightening cap (Figure 7), then use the provided wrench to screw in upper supporting gear and wrest screw tight.
- Thread the socket head cap screws into lower tightening cap (Figure 7), then use the provided wrench to screw in lower supporting gear and wrest screw tight.

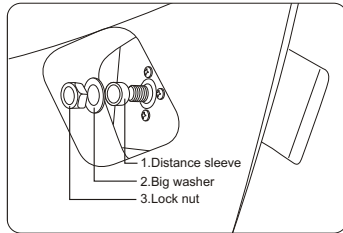

Figure6

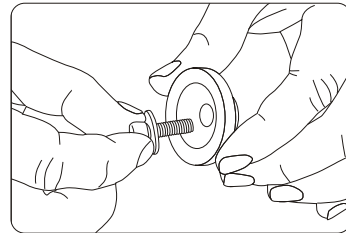

Figure7

- Respectively connect air pipe and valve connector with relavent connectors on the iron plate of armrest (Figure 8).
- Check if the armrest is well fixed. If there isn't much swing, close the big and small cover outside the armrest. (Figure 9).
- Close the zipper of lower armrest and finish installation.

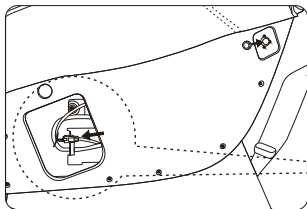
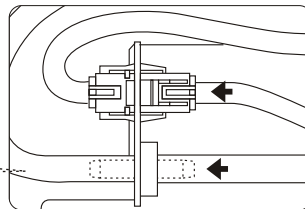

Figure8



Enlarge sketch map

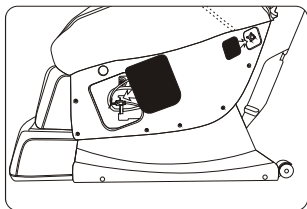

Figure9

Method of usage

Be careful don't put stress on the two sides of armrest in order to support the body (Figure 10)

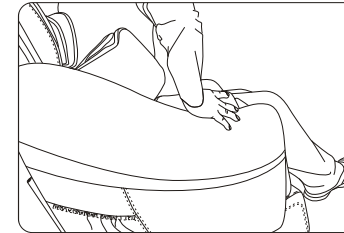

Figure10

Be careful don't put stress inwardly on upper arm airbag support board (Figure 11)

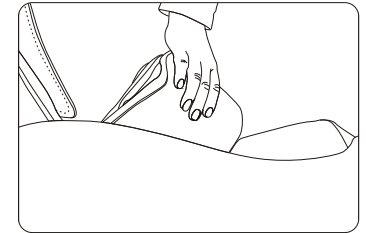
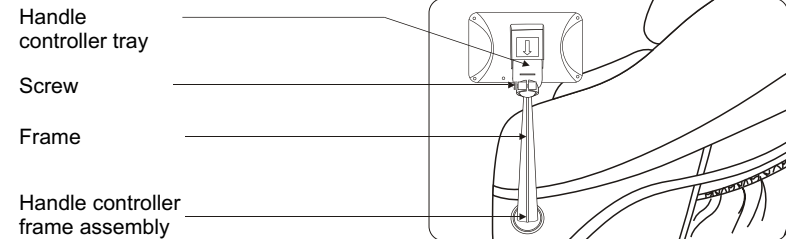
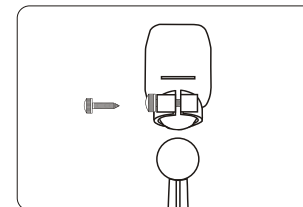

Figure11

7.Handle controller frame installation



- Ready for the handle controller tray, steel pole, take out the fixed screws on the handle controller tray. (Figure 1)
- Insert the ball joint of the steel pole to the concave spherical of the handle controller tray.(figure 2)



(Figure 1)

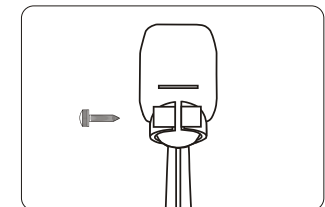

(Figure 2)

Method of usage

- Screw the screws in to the hole which got in step 1 and tighten it, take care the direction, should be screw it from right to left. (Figure 3)
- Prepare the cylindrical fixed pipe.(Figure 4)

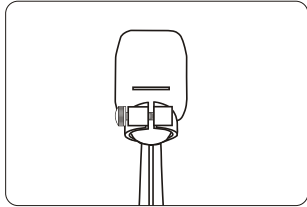

(Figure 3)

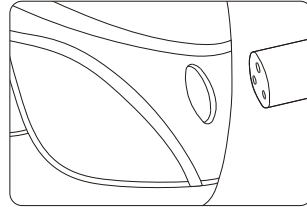

(Figure 4)

- Put the cylindrical fixed pipe in to the hole on the right armrest, take care that the sthere hole on the fixed pipe should be one to one corresponded with the hole on the arm rest of the flange plate. (figure 5)
- Screw three screws to tighten it (figure 6)



(Figure 5)

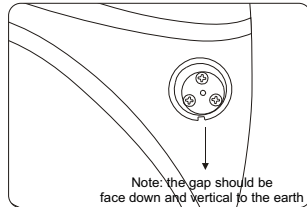

(Figure 6)

- Prepare the handle controller frame assembly in step 3.(figure 7)
- Insert the handle controller frame assembly in to the cylindrical fixed pipe, be carefully that the two groups hole out side and inside should be one to one correspond.(figure8)

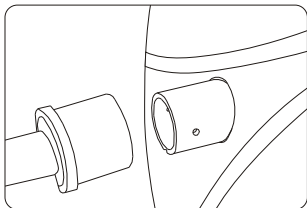

(Figure 7)

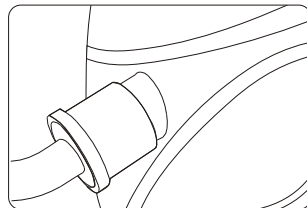

(Figure 8)

Method of usage

- Prepare two screws which tighten on two sides (figure 9)
- Screw the two screws on two sides make it tighten, finish the installation(figure 10)

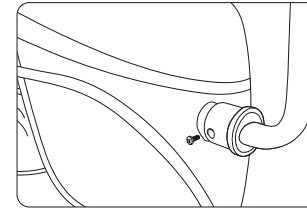

(Figure 9)

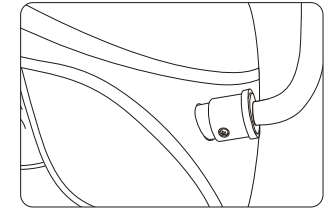

(Figure 10)

8.Controller installation and usage

Insert the handle controller in to the frame (figure 1), the frame can turn left and right freely(Figure 2).and the handle controller can swing freely in horizontal direction(Figure 3).

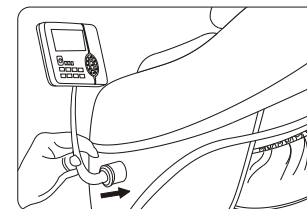

(Figure 1)

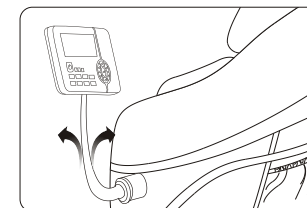
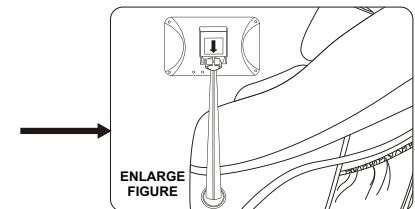

(Figure 2)

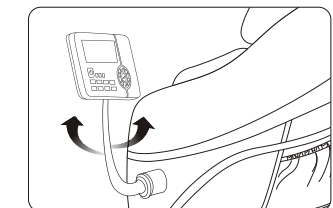

(Figure 3)

Method of usage

9.floor Protection

Put the heavy massage chairs on the wood floor for a longtime may damage the floor, so please place a carpet or other object to avoid this damage.

Caution: Do not move the chairs with its wheels on wood floor, rough ground or in a narrow space. Two people are required to lift the chair.

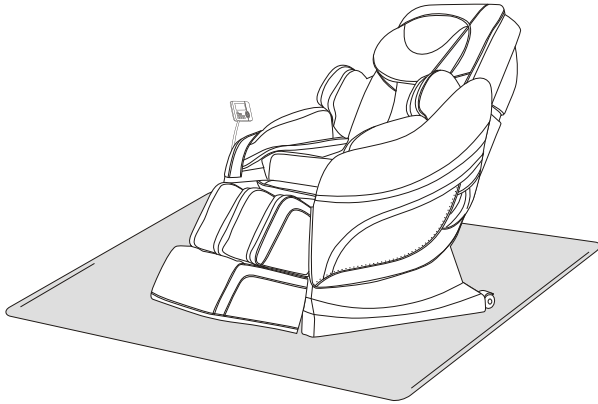

10.method of movement

Make sure that all wires are far above the ground, tilt the backrest backward to a certain degree (with the gravity center resting on the wheels), push the chair forward or backward with your hands and finally resume the chair to the normal position in a slow and gentle manner.

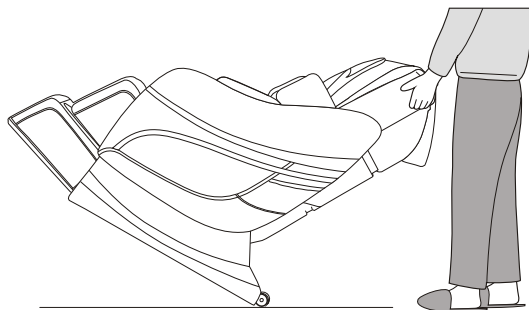

Product specification

Model: A33

Description: Full Body Air-massage Chair

Configure: 05

Rated Voltage: 110-120V~ 60Hz
220-240V~ 50Hz / 60Hz

Rated Power Input: 220W

Rated Working Time: 20Minutes

Safety Design: Class I

Material introduction: PVC, PA, steel parts and electric &ele-ctron parts

MATERIAL	PU	LEATHER	CLOTH	WOOD

