

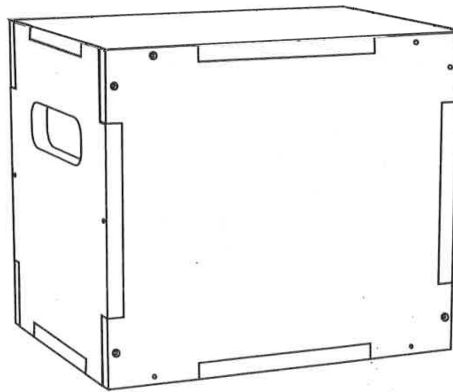

Wooden Plyo Box

User manual



ATTENTION

WARNING:

Before beginning any exercise program consult your physician. This is especially important for people who are over 35 years old or who have pre-existing health problems. Read these instructions carefully before using the VirtuFit Wood Plyo Box. You receive important information about the use and safety of your VirtuFit Wood Plyo Box. VirtuFit takes no responsibility for any injuries or property damage caused by the use of this fitness equipment.

TOOLKIT

When you open the carton, and you will find the below parts in the carton:

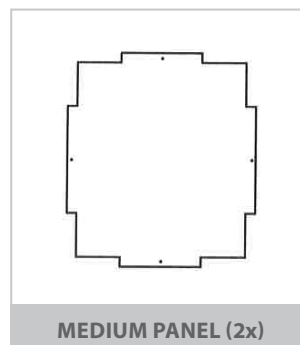
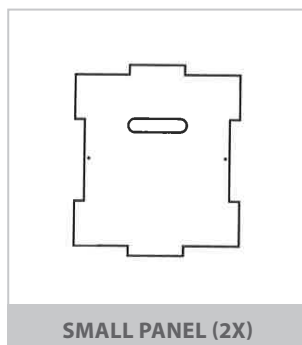
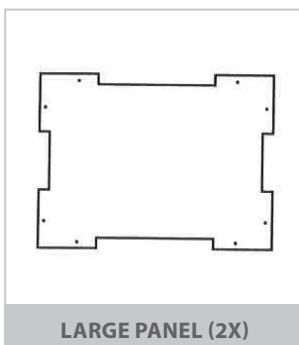

ASSEMBLY INSTRUCTIONS

STEP 1

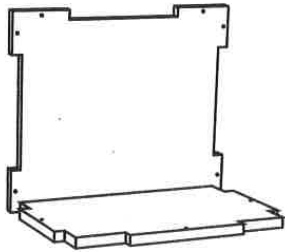

Start by identifying the bottom and placing the finished side down. Connect one of the sides to the base and install the one screw on the side that will connect the two pieces. Provided you don't start moving the base, this should remain secure.

STEP 2

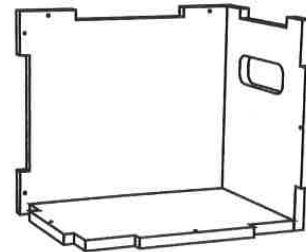

Install the second side by fitting in to the slot on the base and the adjacent side. Install 2 screws, one screw attaching to the piece at the floor and the other screw at the center connecting the two vertical side pieces. You will install the remaining screws when all sides are assembled.

STEP 3

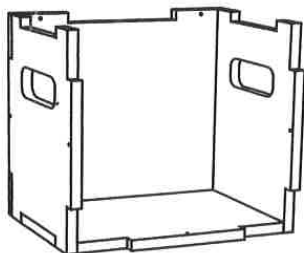

Repeat step 2 for the third side.

STEP 4

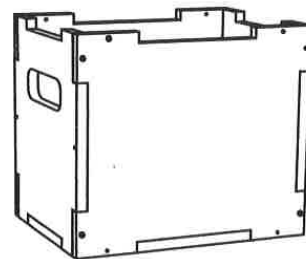

Install the fourth side with 3 screws. The center screw on each side and the screw at the center connecting this side to the bottom panel.

STEP 5

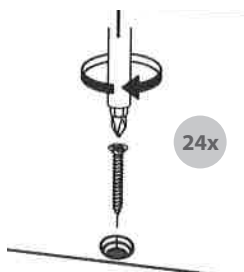

Fix all the screws with an electric screwdriver.

STEP 6

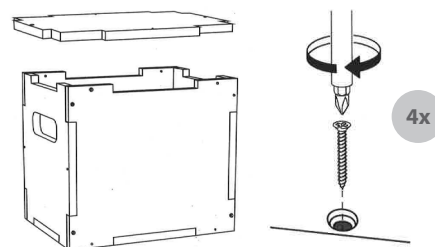

- Place the top on the structure and install all screws on the top.
- Rotate the VirtuFit Wood Plyo Box and install all remaining screws so that they sit flush with the surface of the VirtuFit Wood Plyo Box.